



MT65 BELUGA V

Mobile Computers

Disclaimer

© 2023 Newland Europe BV. All rights reserved.

Please read the manual carefully before using the product and operate it according to the manual. It is advised that you keep this manual for future reference.

Do not disassemble the device or remove the seal label from the device; doing so will void the product warranty provided by Newland Europe BV.

All pictures in this manual are for reference only, and the actual product may differ.

Regarding product modification and update, Newland Europe BV reserves the right to make changes to any software or hardware to improve reliability, function, or design at any time without notice. The information contained herein is subject to change without prior notice.

The products depicted in this manual may include software copyrighted by Newland Europe BV or a third party. The user, corporation or individual shall not duplicate, in whole or in part, distribute, modify, decompile, disassemble, decode, reverse engineer, rent, transfer, or sublicense such software without prior written consent from the copyright holders.

This manual is copyrighted. No part of this publication may be reproduced, distributed, or used in any form without Newland Europe BV's written permission.

Risk Warning Regarding Unauthorized System Updates:

You should use the Newland-provided tool to update this product's system. Modifying system files by installing a third-party ROM system or using any cracking method may result in product malfunction or data loss and void your warranty.

Newland Europe BV reserves the right to make a final interpretation of the statement above.

Newland Europe BV

Rolweg 25, 4104 AV, Culemborg,
The Netherlands
www.newland-id.com

Newland Europe BV is a subsidiary of Newland Digital Technology Co., Ltd. Our general conditions of Purchase, Sale and Delivery are filed with the Record Office of the Chamber of Commerce of Utrecht, The Netherlands.

K.v.K. H.R. Utrecht / Chamber of
Commerce Utrecht:
Reg. nr. 17109876

Revision History

Version	Description	Date
V1.0.0	Initial release	2019-05-06
V1.0.1	Updated with Newland App User Guide Description	2020-05-28

Contents

Chapter 1 Getting Started	1
Introduction.....	1
Documentation Set.....	1
Chapter Descriptions.....	1
More Information	2
Chapter 2 Getting Started	3
Introduction.....	3
Getting Started	4
The MT65.....	4
Cradle (optional)	6
Installing the Battery	7
Removing the Battery	7
Charging the Battery	7
Keypad.....	10
Communicating with PC.....	11
Installing the MicroSD Card/SIM Card/PSAM Card	12
Chapter 3 Basics	13
Introduction.....	13
Switching On/ Restart/Switching Off the MT65.....	13
Locking/Unlocking the MT65	14
Home Screen	14
Status Icons.....	15
Installing App.....	16
Uninstalling App.....	16
Date & Time.....	17
Display.....	17
Ringtones	18
Restoring Factory Settings	18

Language & Input Method	19
Shortcuts to Apps	20
Widgets	20
Chapter 4 Scanning Barcodes	21
Introduction.....	21
Scanning 1D Barcode	21
Scanning 2D Barcode	22
Programming Scanner.....	23
Enable Scan.....	23
Output Mode.....	24
Scan Mode	24
Scan Trigger.....	25
Prefix & Suffix.....	26
Good Read Indicator	27
Encoding	27
Data Edit.....	28
Symbologies.....	29
Chapter 5 Bluetooth	31
Chapter 6 Wi-Fi	32
Introduction.....	32
Wi-Fi Settings.....	32
IP Settings	33
Chapter 7 Mobile Network	34
Introduction.....	34
Mobile Network Settings.....	34
APN Settings	34
Chapter 8 Admin Tool.....	36
Introduction.....	36
Admin Mode Setting	36

Switching between User Mode and Admin Mode	38
Chapter 9 Whitelist Manager	39
Introduction.....	39
Logging in to Whitelist Manager	39
Chapter 10 Others	40
Camera.....	40
GPS.....	41
NFC (optional)	41
Memory Cleanup	42
Chapter 11 System Update	43
Introduction.....	43
Online Update	43
Locate Update	43
Chapter 12 App Development Guide.....	48
Development Environment	48
Use of Non-standard Interfaces.....	48
Chapter 13 Maintenance & Troubleshooting.....	49
Introduction.....	49
Important Safety & Handling Information.....	49
Disassembly and Retrofit	49
External Power Supply.....	49
Abnormal Situation.....	49
Drop Damage.....	49
LCD Screen	49
Stacking Heavy Objects.....	49
Mounting Location.....	49
Wireless Functionalities	49
Use & Maintenance.....	50

Battery Safety Guidelines.....	50
Troubleshooting.....	51

Chapter 1 Getting Started

Introduction

This guide provides instructions for programming and operating the NLS-MT65 portable data collector (hereinafter referred to as “the MT65” or “the terminal”).

Documentation Set

The documentation set for the MT65 includes:

- ✧ **NLS-MT65 Portable Data Collector Quick Start:** Describes how to get the NLS-MT65 up and running.
- ✧ **NLS-MT65 Portable Data Collector User Guide:** Describes how to program and use the NLS-MT65.
- ✧ **Newland APP User Guide:** Describes how to install/uninstall, or use the APPs developed by Newland (For GMS Version Only)

Chapter Descriptions

- ✧ *Chapter 1 About This Guide* Provides general description of this manual.
- ✧ *Chapter 2 Getting Started* Provides information on getting the MT65 up and running for the first time.
- ✧ *Chapter 3 Basics* Describes how to program the MT65 for the use of its basic features.
- ✧ *Chapter 4 Scanning Barcodes* Provides the instructions as to how to scan 1D/2D barcodes and how to program the scanner.
- ✧ *Chapter 5 Bluetooth* Explains how to use Bluetooth functionality.
- ✧ *Chapter 6 Wi-Fi* Explains how to use Wi-Fi functionality.
- ✧ *Chapter 7 Mobile Network* Explains how to use Mobile Network functionality.
- ✧ *Chapter 8 Admin Tool* Explains how to use the admin tool.
- ✧ *Chapter 9 Whitelist Manager* Explains how to use the whitelist management tool.
- ✧ *Chapter 10 Others* Explains how to use Camera, GPS and NFC functionalities.

- ✧ *Chapter 11 System Update* Explains how to update the system.
- ✧ *Chapter 12 App Development Guide* Describes the app development environment and the use of non-standard interfaces.
- ✧ *Chapter 13 Maintenance & Troubleshooting* Provides troubleshooting solutions for issues that might occur when using the MT65

More Information

For more product and support information, please visit our web site: <http://www.newlandaidc.com>.

Chapter 2 Getting Started

Introduction

This chapter lists the parts and accessories for the MT65 and explains how to install, remove and charge the battery, and power on the MT65 for the first time.

Getting Started

The MT65

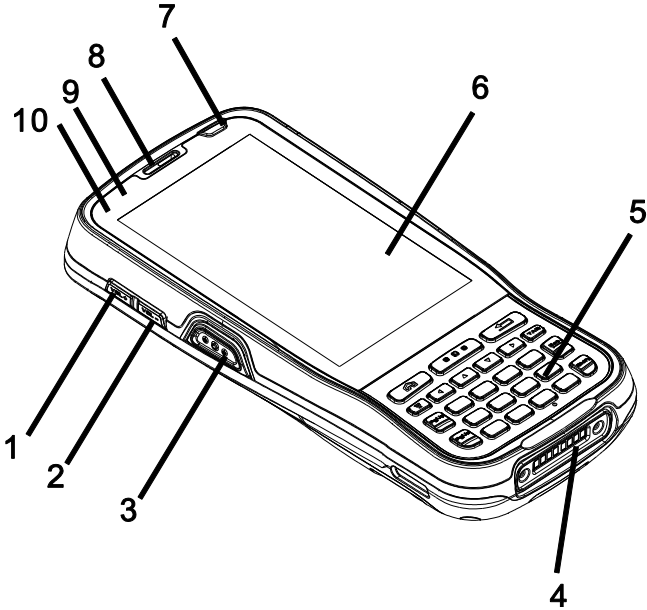

1	Volume+	2	Volume-
3	Left Scan Key	4	Cradle Connector
5	Keypad	6	Capacitive Touch Screen
7	Power key	8	Earpiece
9	Blue LED	10	Red LED

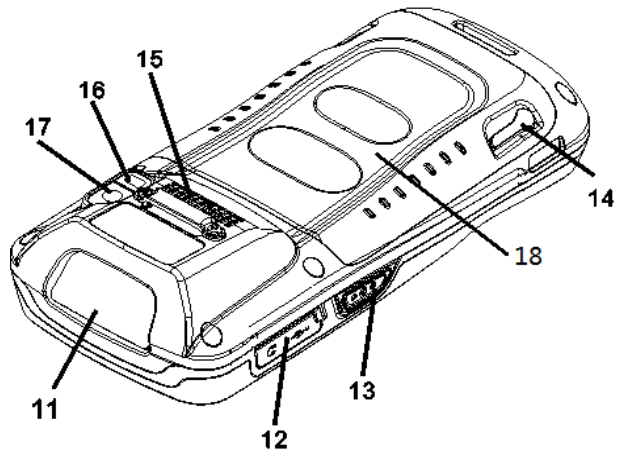

11 Scan Window

12 USB/Headset Connector Cover

13 Right Scan Key

14 Battery Cover Latch

15 Speaker

16 Flashlight

17 Rear Camera

18 RFID Reader (Optional)

Cradle (optional)

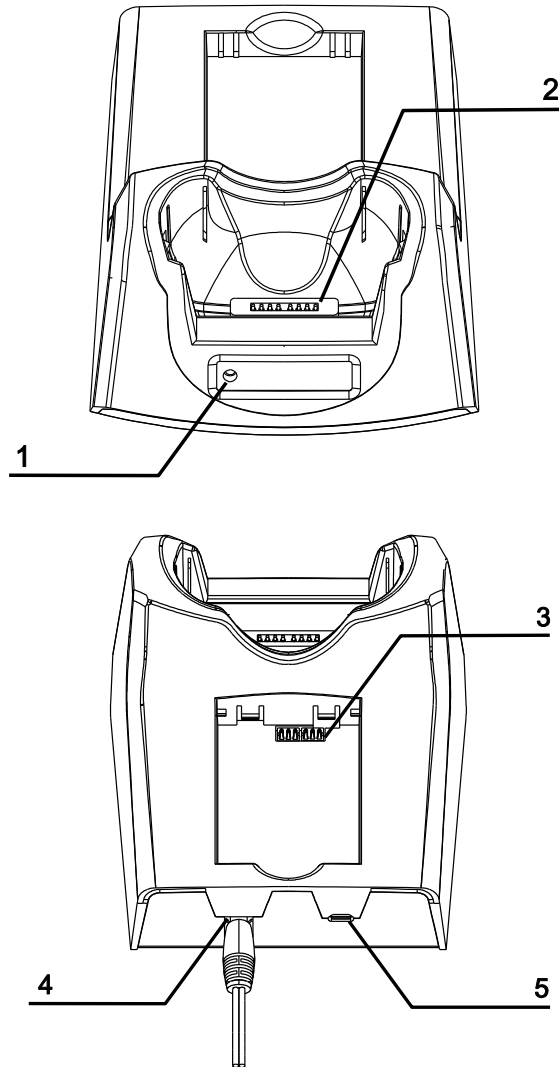

1 Charging LED

2 MT65 Connector

3 Battery Compartment

4 Power Jack

5 Micro USB Port

Installing the Battery

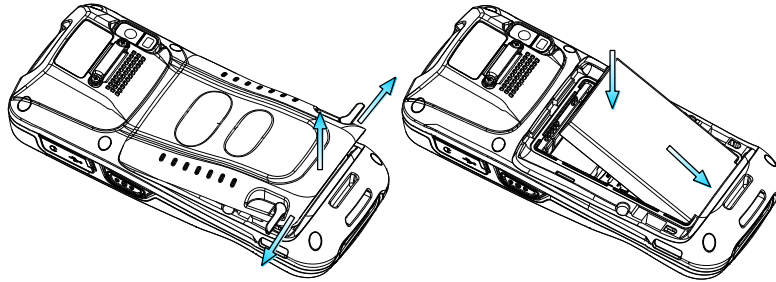

Step 1: Unlock the battery cover latches as shown in the figure above and then remove the cover.

Step 2: Insert the battery as indicated into the battery compartment, with its metal contacts facing down and lining up with the metal contacts on the inside of the terminal.

Removing the Battery

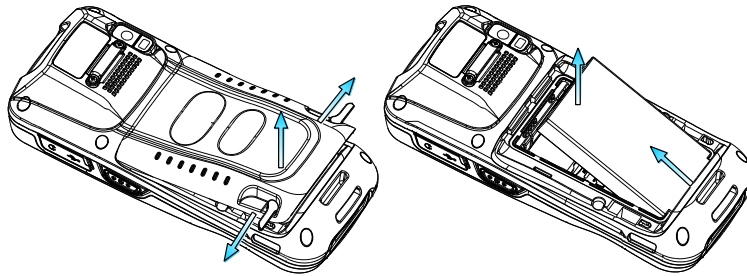

Step 1: Hold down the Power key for 5 seconds and then tap “Power off” to turn off the terminal. Unbuckle and loosen the hand strap. Unlock the battery cover latches and remove the cover.

Step 2: Remove the battery.

Charging the Battery

There are two methods to charge the battery.

- ✦ **Charge with AC adapter:** Connect the MT65 to a power outlet using the included AC adapter. It takes about 4.5~5 hours to fully charge it (The terminal is shut down or in sleep mode).



Note: Low battery may result in malfunction of the terminal. Before using MT65 for the first time, charge the battery for at least 8 hours.

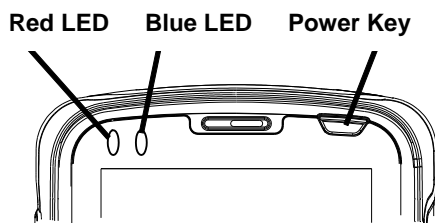

MT65 LED Charging Indicators	
Blue LED on	Fully charged
Red LED on	Charging in progress
Red LED flashes constantly	Low-battery alert

Note: If MT65 battery is completely drained, please press the power key to turn it on after 15 minutes of being charged.

- ❖ **Charge with cradle:** Insert the MT65 into the charging slot or put the battery into battery compartment on the cradle. Connect the cradle to a power outlet using the included AC adapter (for the cradle).

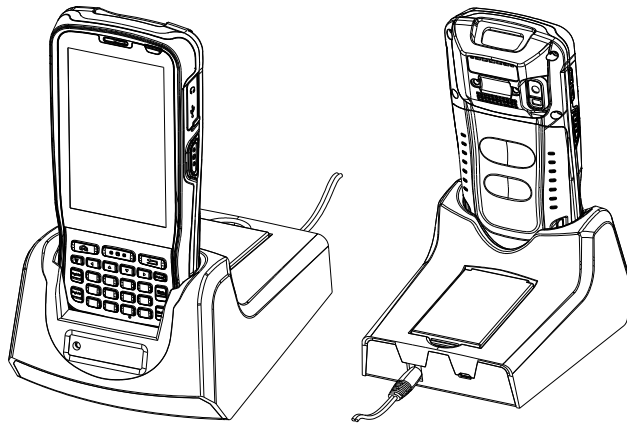

Note: If MT65 battery is completely drained, please press the power key to turn it on after 15 minutes of being charged.

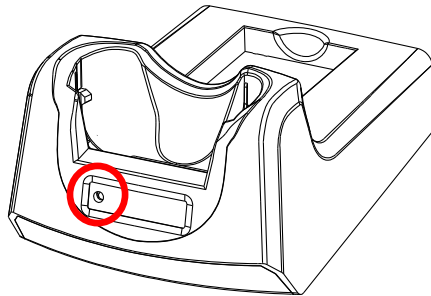

MT65 Cradle LED Charging Indicators	
Green LED on	Fully charged
Red LED on	Charging in progress
LED off	Battery not found

Note: The cradle's Charging LED only indicates the charge statuses of the battery. When charging the MT65 with the cradle, the user is notified of charge statuses of the terminal by the LEDs on the terminal.

Keypad

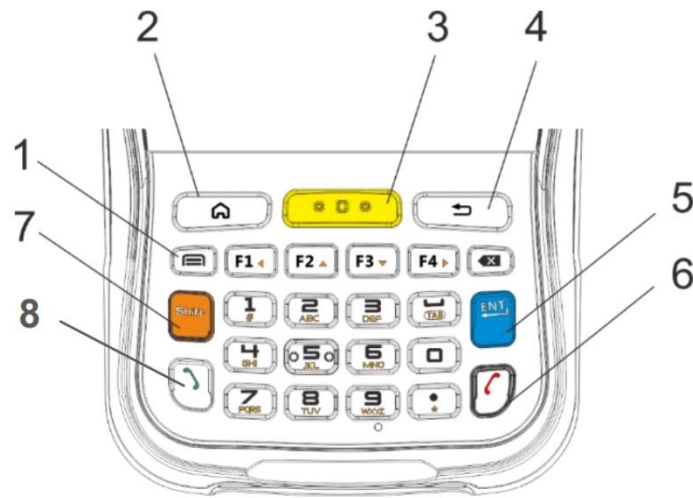

1	Menu Key	2	Home Key
3	Scan Key	4	Back Key
5	Enter Key	6	End Call Key
7	Number-Function Switch	8	Call Key

The MT65 has 30 keys including function, alphanumeric, navigation and scan keys.

Home Key: Press it to go to the Home Screen.

Back Key: Press it to go back to the previous screen.

Menu Key: Press it to display the app(s) most recently used. Tap an app to open it or tap “Clear All” to remove all apps at once.

End Call Key: Press it to end a phone call.

Number-Function Switch: Press it to toggle between numeric (white) and function (orange) keys.

Call Key: Press it to view call history/ make a call/ receive a call.

Communicating with PC

Step 1: Connect the Micro USB port on the MT65 to your computer with the included USB cable.

Step 2: Switch the MT65 on. On the Home screen, swipe from top to bottom with one finger in one smooth motion to open the notification bar as shown below.

Step 3: Tap "Tap for more options".

Step 4: Select "Transfer files". Navigate to the "My Computer" section of your computer and look for the newly added drive. Double-click it and you will be connected to the MT65. Then you may handle the files on the terminal through your computer.

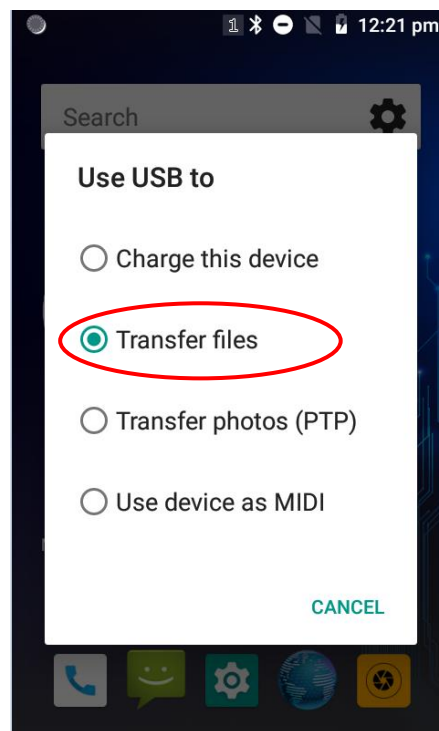
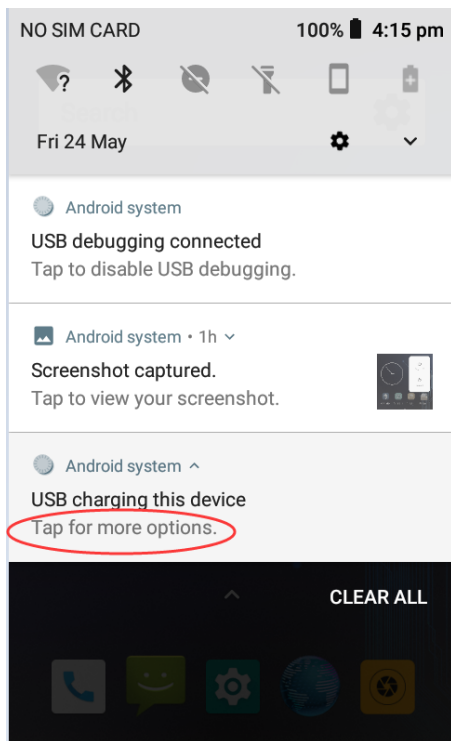

Installing the MicroSD Card/SIM Card/PSAM Card

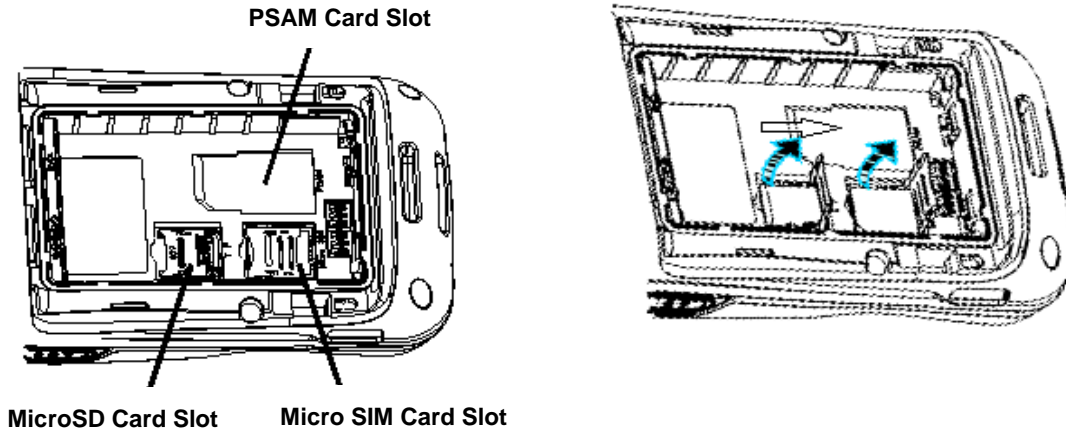

Step 1: Unbuckle and loosen the hand strap. Unlock the battery cover latch and remove the cover and battery. Slide the slot cover rightward and Lift the left end of it.

Step 2: Insert the Micro SD card/Micro SIM card into the holder, with its metal contacts facing down. Close the slot cover and slide it leftward until it clicks.

Step 3: Insert PSAM card from left to right into the corresponding card slot.

Chapter 3 Basics

Introduction

This chapter provides the basics of setting and using the MT65.

Switching On/ Restart/Switching Off the MT65

After installing the SIM card and battery and having the MT65 fully charged, you may switch the terminal on.

Switch the MT65 on: Hold down the Power key on the top-right corner of the terminal until the terminal vibrates. Note that the initialization is going to take some time before the MT65 displays the Home screen.

Restart the MT65: Hold down the Power key on the top-right corner of the terminal until the window below pops up, then tap “restart”.

Switch the MT65 off: Hold down the Power key on the top-right corner of the terminal until the window below pops up, then tap “Power off”.

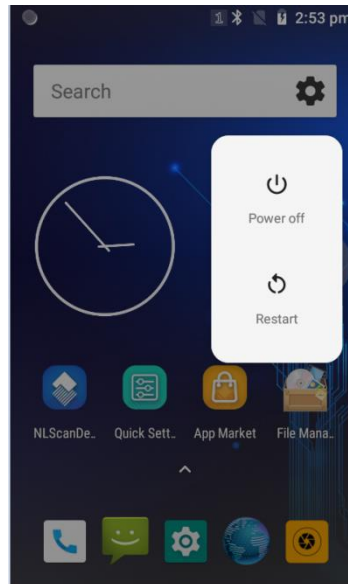

Locking/Unlocking the MT65

Lock the MT65: Briefly press the Power key . If no operation is performed on the MT65 for a preset period of time, the MT65 locks automatically. You can change how long it takes for the MT65 to lock.

Unlock the MT65: Briefly press the Power key , then swipe up from the bottom of screen  .

Home Screen



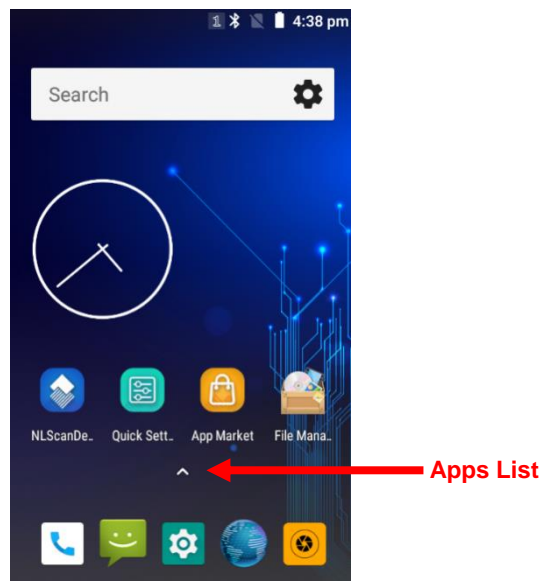







- ❖ **Go to the home screen:** Press the Home key
- ❖ **View another home screen:** Swipe left or right.
- ❖ **Open an app:** Tap it.
- ❖ **View all apps/Open apps list:** Tap 

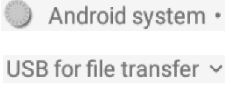
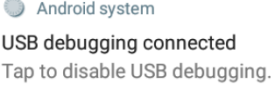

- ❖ **Add an app icon to the Home screen:** Tap  on the Home screen. Tap and hold your desired app until it appears on the Home screen and then drag it into a blank area.
- ❖ **Delete an app icon on the Home screen:** Tap and hold your desired app on the Home screen until "X Remove" appears, then drag the app into it. Note that this operation only removes the icon from the Home screen. To remove the app from the MT65, see the **Uninstalling App** section.

Status Icons

The icons in the status bar at the top of the screen give information about the MT65.

Status Icon	Description	Status Icon	Description
	WLAN		Signal strength
	Bluetooth		Airplane mode
 Android system • USB for file transfer ▾	USB connected	 Android system USB debugging connected Tap to disable USB debugging.	USB debugging
	Missed calls		Battery charging in progress
	New messages		Battery fully charged
	Mute mode		Vibrate ON

Installing App

Use one of the following methods to install a new app on the MT65:

1. Download an APK file from online app store and install it.
2. Download software package onto a MicroSD card or copy it to your terminal through USB cable. Then install it with File Manager.
3. Connect the MT65 to PC with the supplied USB cable. Install a new app using the mobile assistant (such as Baidu Mobile Assistant) installed on the PC.

Uninstalling App

Follow the procedure below to remove an app from the MT65:

Tap  on the Home screen to view all apps. Tap and hold your desired app until “App info” appears, then tap “App info” and uninstall it

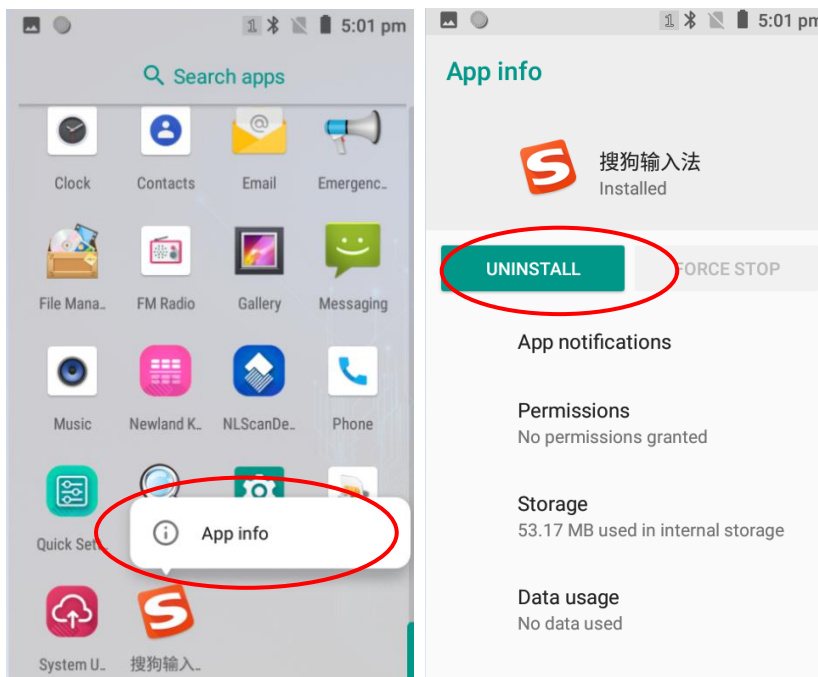

Date & Time



Set the date and time: Tap the app icon  and then “System” -> “Date & time”, and set the date and time on the screen shown below as per your needs.

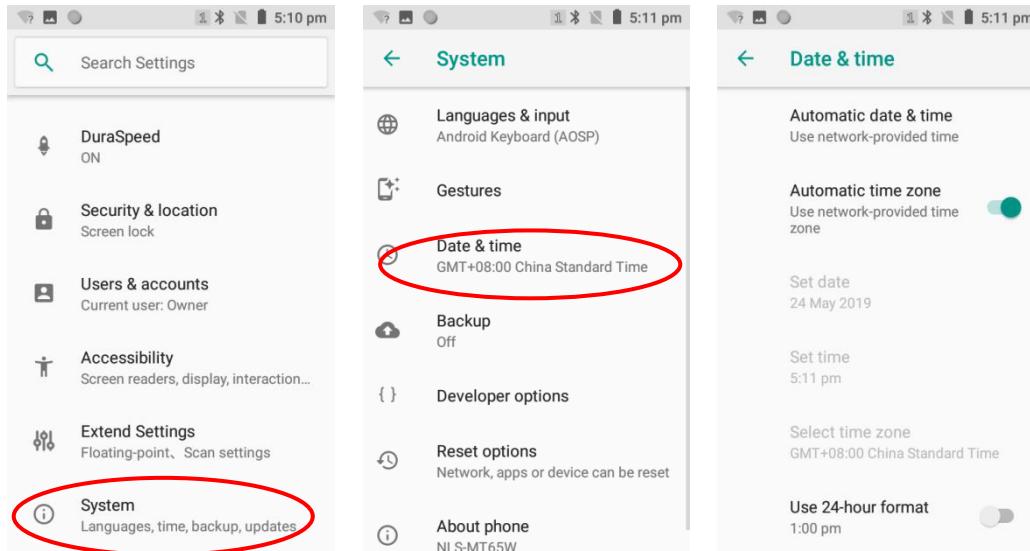

Display



Tap the app icon  and then “Display”. Then set the brightness, wallpaper, sleep timer, front size and other items on the screen as per your needs.

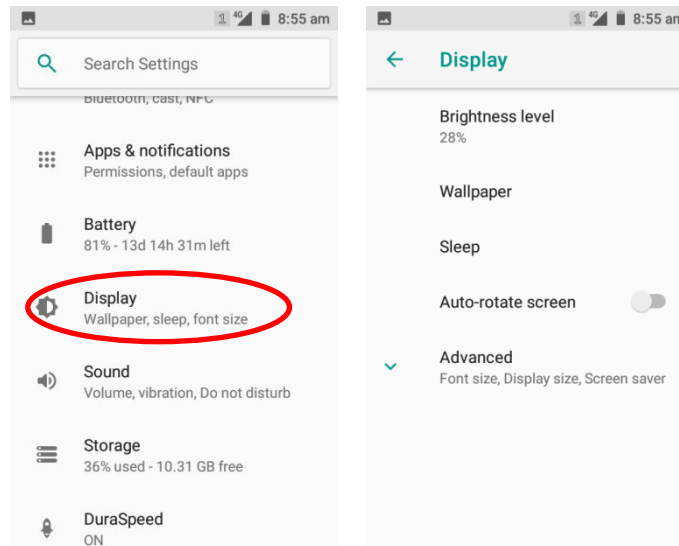

Ringtones



Tap the app icon -> "Sound". Then set the ringtones and other notification sounds as per your needs.

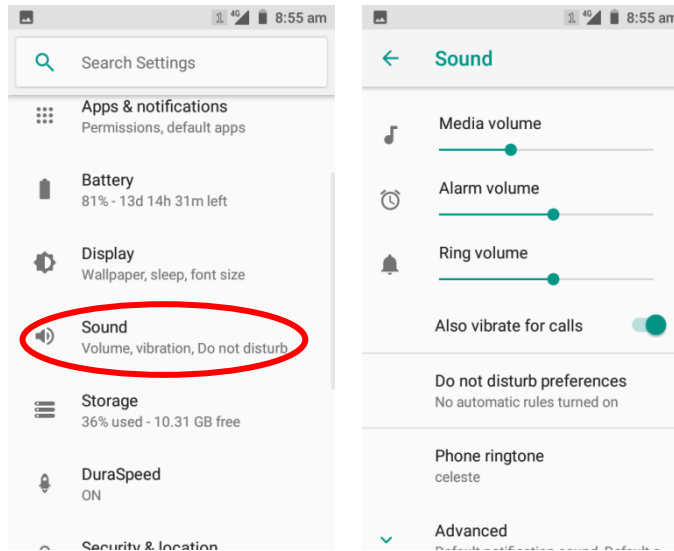

Restoring Factory Settings



Tap the app icon -> "System" -> "Reset options" -> "Erase all data (factory reset)" -> "RESET PHONE" -> "ERASE EVERYTHING"

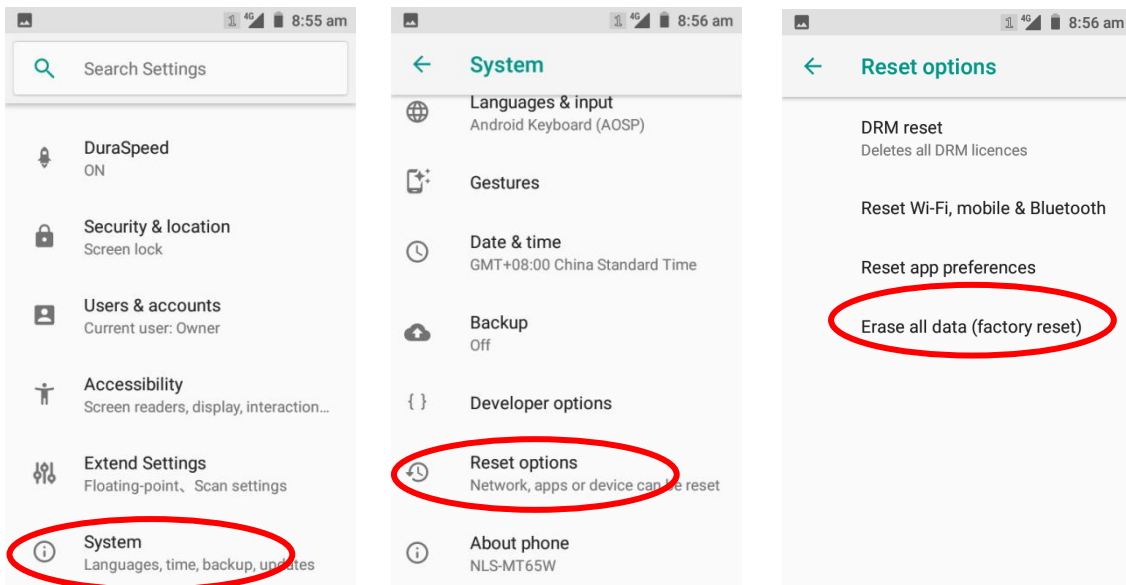

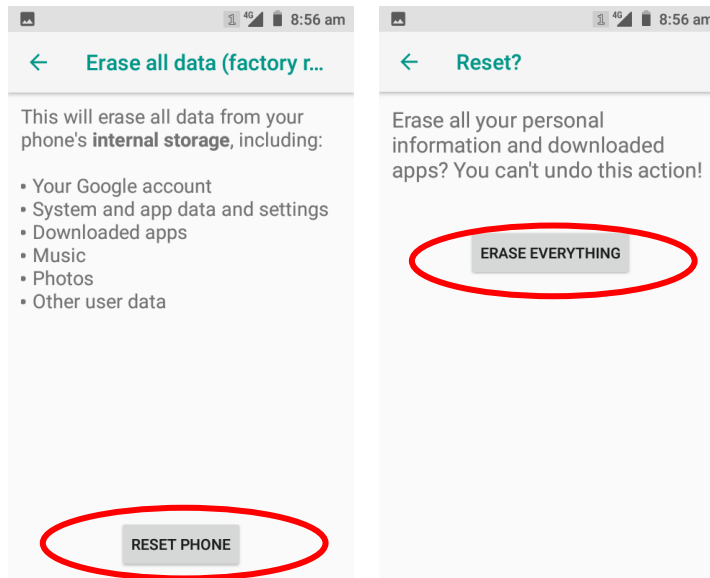

Language & Input Method



Tap the app icon -> "Languages & input". Then set the language and input method as per your needs.

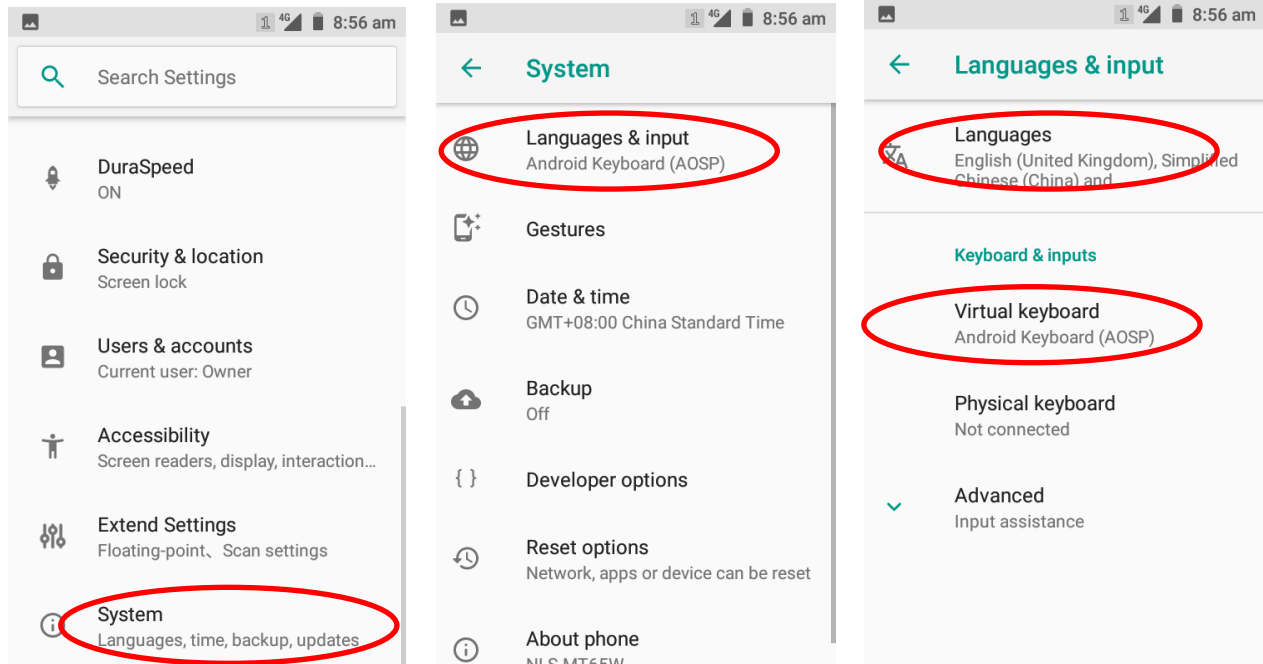

Shortcuts to Apps

Create a shortcut to an app on your Home screen: Tap  on the Home screen. Tap and hold your desired app and then drag it into the home screen.

Widgets

View all widgets: Tap and hold the Home screen and then tap .

Open a widget: Tap it.

Add a widget icon to the Home screen: Tap and hold the Home screen and then tap . Tap and hold your desired widget and then drag it into the home screen.

Chapter 4 Scanning Barcodes

Introduction

This chapter includes scanning tips and instructions for setting up the scanner.

Scanning 1D Barcode

Adjust the scan angle or the distance between the MT65 and the target barcode to ensure the length of laser beam is roughly 8mm greater than that of the barcode, as shown below:

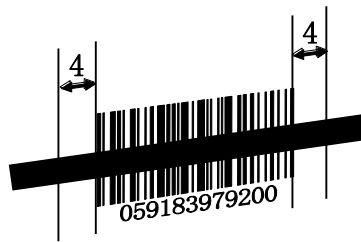

Correct	Wrong

Scanning 2D Barcode

Adjust the scan angle and the distance between the MT65 and the target barcode to make them fall into the following ranges:

1. Point the MT65's focus lamp at the center of the barcode.
2. Move the MT65 until you find the appropriate scan distance.
3. Optimum scan angles:



Skew (α) < 45° (0° preferably)

Pitch (γ) < 45° (5° - 20° preferably)

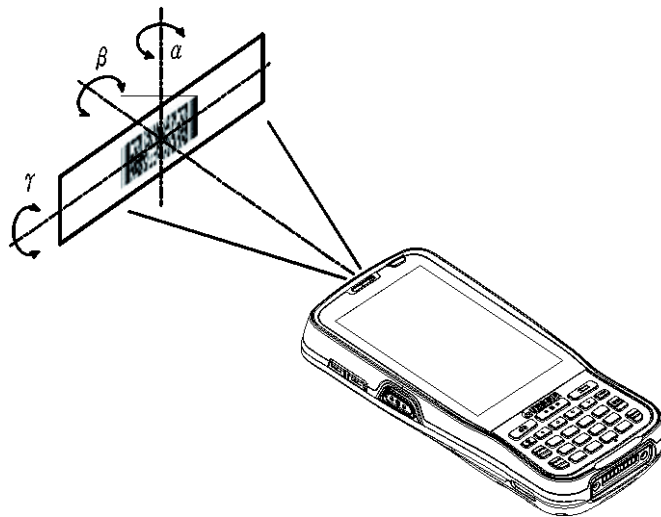
Roll (β) = 0° - 360°



Programming Scanner

Tap the app icon  -> “Extend Settings” -> “Scan Settings”, or tap the app icon  on the home screen-> tap the app icon  to set the scanner parameters as per your actual needs.

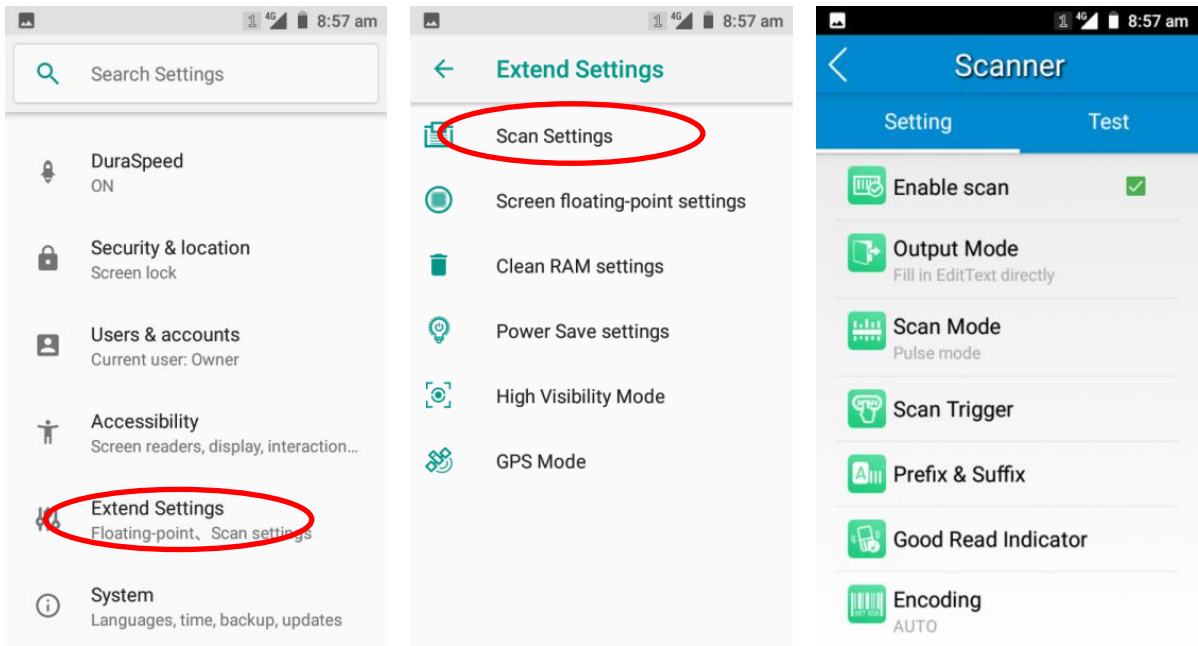

Enable Scan

Check or uncheck the “Enable scan” item to enable or disable the scanning feature of the MT65.

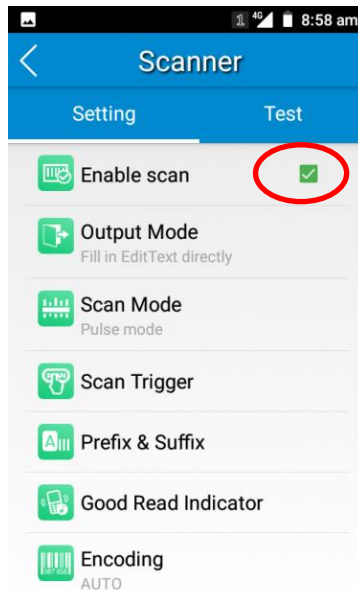

Output Mode

The MT65 provides three output modes: Simulate keystroke, Output via API and Fill in EditText directly.

1. **Simulate keystroke:** Output scanned data to keyboard buffer to simulate keyboard input. Character interval (ms): A character interval of 0-100 milliseconds may be placed between the transmission of each character of scanned data.
2. **Output via API:** Application acquires scanned data by receiving system broadcasts.
3. **Fill in EditText directly:** Output scanned data at the current cursor position in EditText.

Overwrite output: Clear the text input box before sending the barcode currently scanned to make sure only most recently scanned data is present in the text input box. This feature is available only when Simulate keystroke or Fill in EditText directly is selected.

Output enter-event: Send an Enter Key after each barcode scanned.

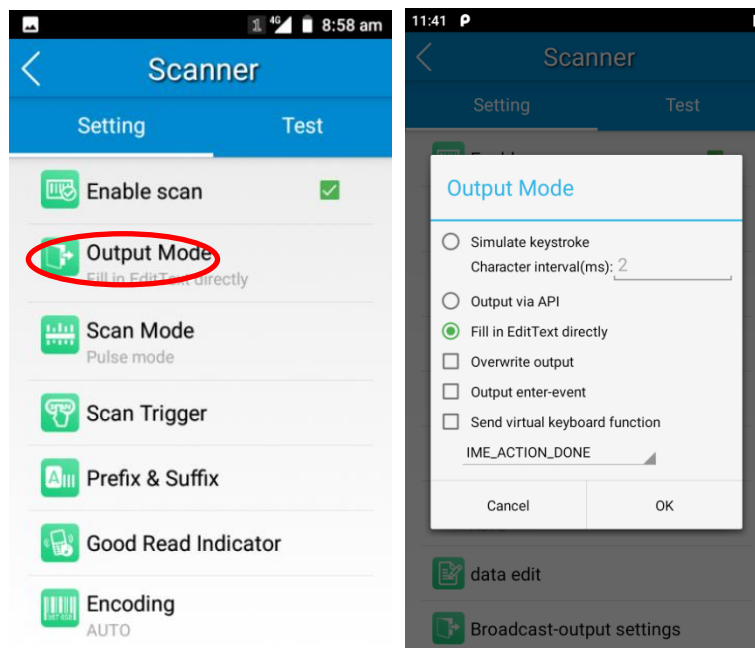

Scan Mode

The MT65 provides four scan modes: Level mode, Continuous mode, Pulse mode and Delay mode.

1. **Level mode:** Press the scan trigger to start a decode session which continues until the trigger is released.
2. **Continuous mode:** Press the scan trigger to continuously read barcodes. To suspend or resume scan operation, simply press the scan trigger.

Scan interval (ms): This parameter sets the timeout between decode sessions.

3. **Pulse mode:** Press the scan trigger to start a decode session which continues until the decode session timeout expires.

4. **Delay mode (Scan on release key):** Press and hold the scan trigger to aim at barcode then release it to start a decode session which continues until the decode session timeout expires or a barcode is decoded. It is advised to use this scan mode and the Central Area Decoding feature to insure that only the desired barcodes are read if multiple barcodes are placed closely together.

Decode session timeout (ms): This parameter sets the maximum time decode session continues during a scan attempt. To set it, enter a desired value and then tap “OK”.

Masked repeat interval (ms): This parameter sets the time period before the scanner can read the same barcode a second time.

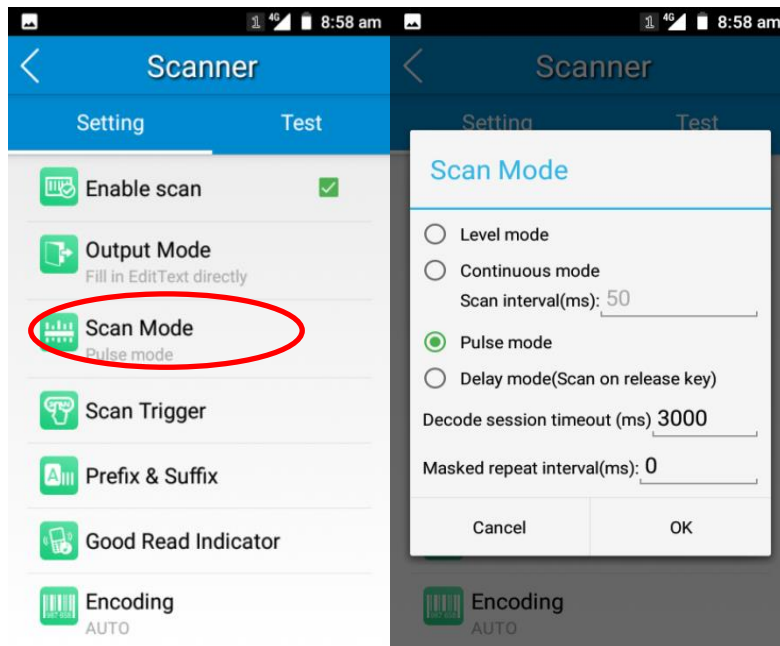

Scan Trigger

The three scan keys on the terminal and the trigger on the pistol grip can all serve as scan trigger. Enable or disable them as per your actual needs.

1. **SCAN key:** Use the Scan key on the front panel of the terminal as scan trigger.
2. **Left/Right SCAN key:** Use the Scan key on the left/right side of the terminal as scan trigger.
3. **Stock SCAN key:** Use the trigger on the pistol grip attached to the terminal as scan trigger.

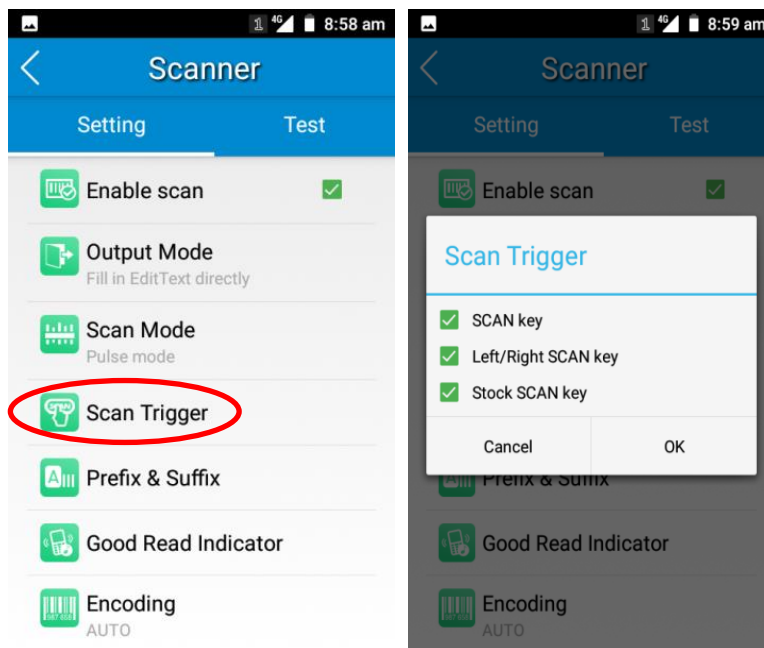

Prefix & Suffix

To set the prefix/suffix, enter the hexadecimal value of a desired prefix/suffix and then tap “OK”. For example, if you want to add a Line Feed character after each barcode, set the suffix to “0A”; if you want to add a Carriage Return character after each barcode, set the suffix to “0D”.

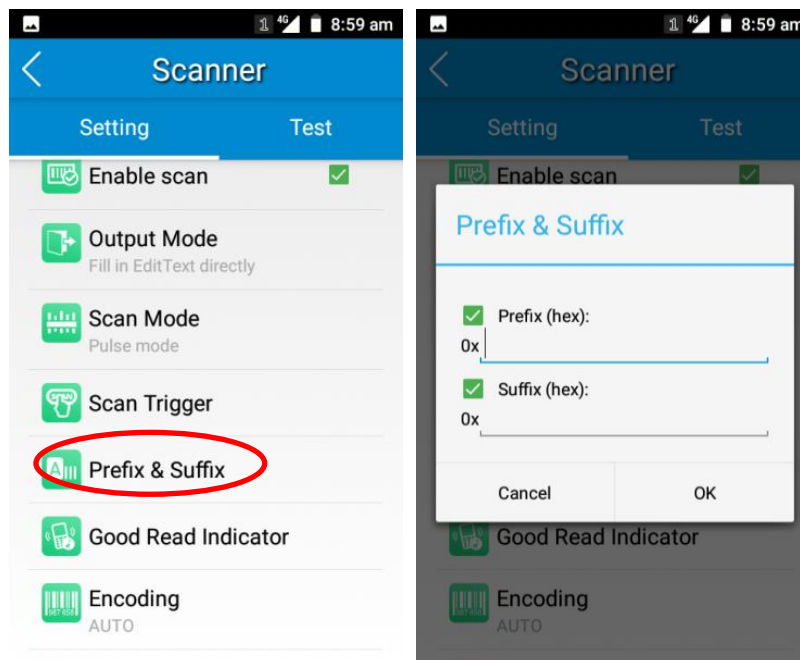

Good Read Indicator

The terminal can use sound/ vibration/ LED to indicate a good read. Choose one or more options as per your actual needs

1. **Sound:** The MT65 issues a short beep to indicate a good read.
2. **Vibrating:** The MT65 vibrates to indicate a good read.
3. **LED:** The blue LED on the MT65 flashes once to indicate a good read.

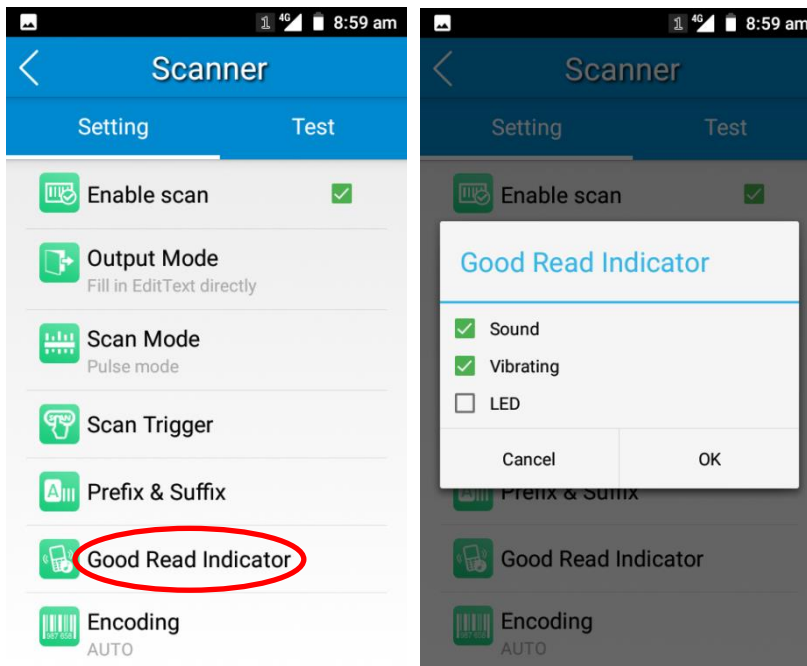

Encoding

Choose a character encoding to interpret barcode data.

1. **AUTO:** The terminal determines automatically if target barcode uses UTF-8, GBK, or ISO-8859-1 encoding. If the terminal produces wrong output, you may need to choose or enter a specific character encoding.
2. **UTF-8:** Dominant Unicode encoding.
3. **GBK:** A character encoding for Chinese characters.
4. **ISO-8859-1:** A common character encoding which covers Western European languages.
5. **Other:** Enter a different character encoding when UTF-8, GBK and ISO-8859-1 are not applicable. If the terminal does not support the encoding entered, this setting will fail.

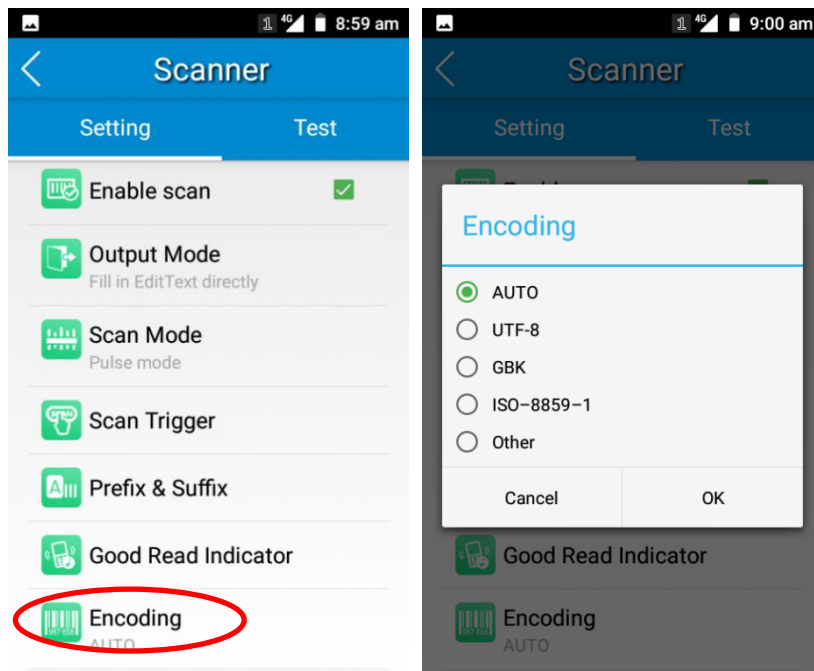

Data Edit

This feature allows you to edit barcode data with a script. Tap “load script” and then select the desired script file on the terminal, or scan the 2D barcode that contains a script, to load the script. Then select “exec script” and tap “OK”.

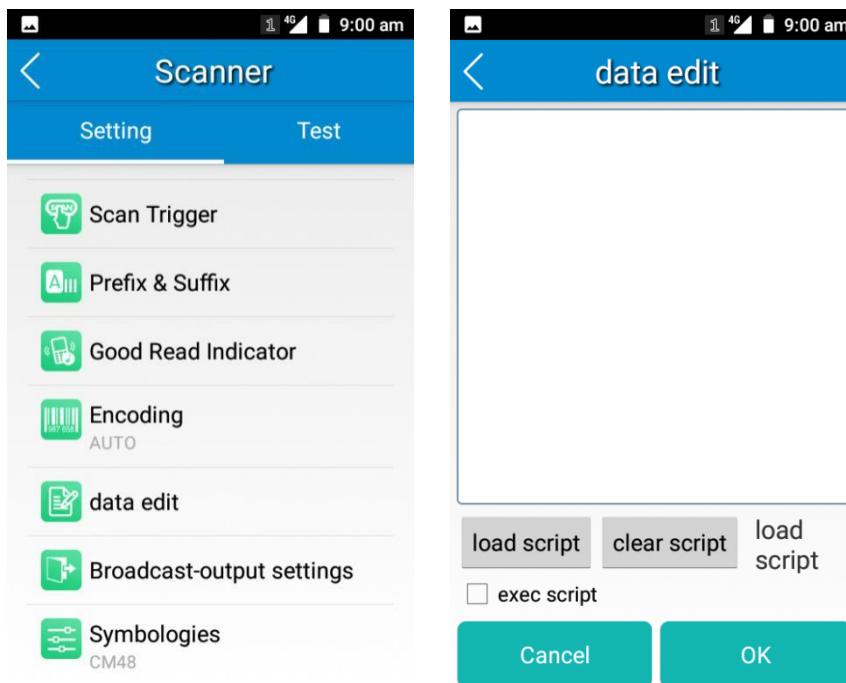

Symbologies

Note that supported symbologies depend on the scan engine integrated in the terminal. Here we will take CM48 for example.

1D code: Enable or disable 1D symbologies and set other barcode parameters.

2D code: Enable or disable 2D symbologies and set other barcode parameters.

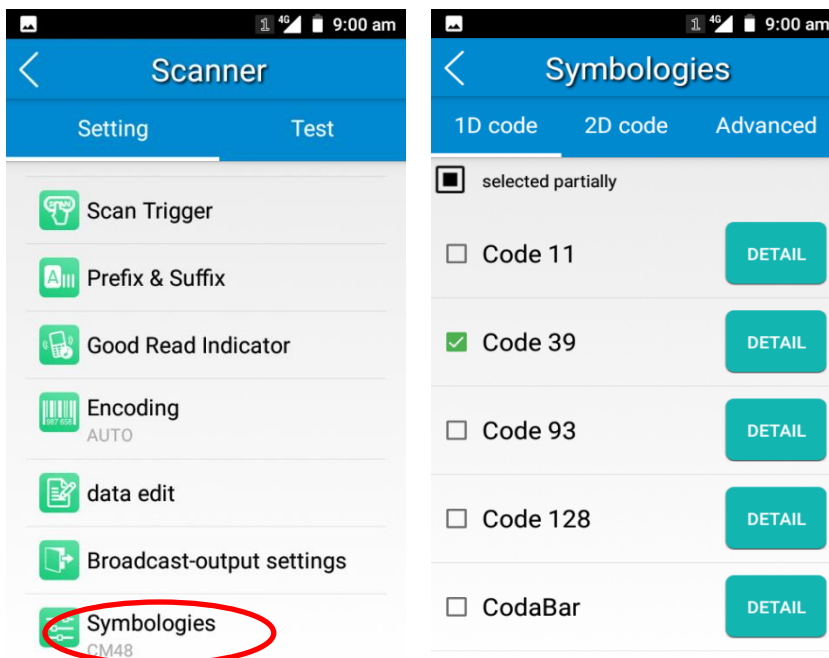

Advanced: The features listed here are designed to improve the scanning performance and energy efficiency of the terminal.

1. **Central area decoding:** When selected, the terminal only decodes the barcode aimed squarely by the aiming pattern. It is advised to select it to insure that only the desired barcodes are read if multiple barcodes are placed closely together.

2. **Other:** Tap DETAIL to access the following parameter settings.

Noise reduction: This feature is designed to reduce noise in images produced by the terminal. However, the terminal shows a slight decrease in scanning speed when using this feature. It is recommended to enable it only when necessary.

Exposure level: Three options are provided.

The Power Plan: Two options are provided.

Power saving: The terminal's built-in scanner turns off automatically after 3 seconds of inactivity.

High-performance: The terminal's built-in scanner turns off automatically after 15 seconds of inactivity.

OCR Enable: Select this check box when reading passports (compliant with ICAODoc9303 standards, TD1/TD2/TD3 supported).

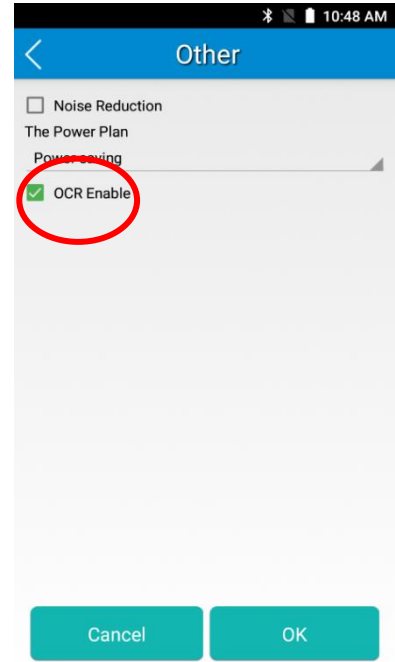
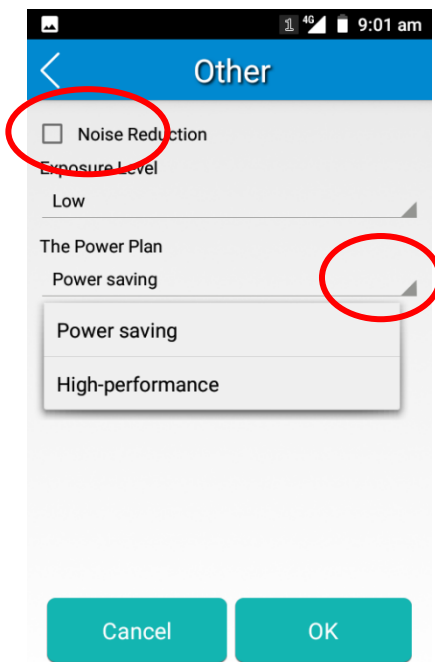
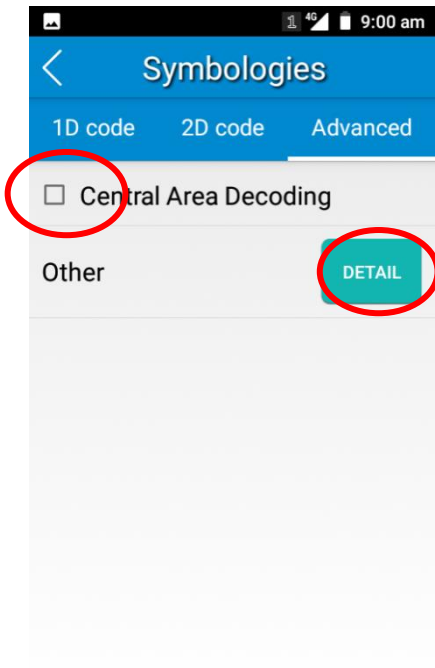

Chapter 5 Bluetooth

This chapter describes how to connect the MT65 to other Bluetooth device.

You can set up a Bluetooth connection between the MT65 and other Bluetooth devices, such as PC, mobile phone. Note that Bluetooth connection works better if there are no obstacles between them.

Before you can use a Bluetooth device with the MT65, you must first pair them.

1. Make the Bluetooth device visible to the MT65.

2. Tap the app icon  -> “Connected devices” -> “Bluetooth”, and turn Bluetooth on to search for available Bluetooth devices.

3. Select the device from the search results to pair.

4. If prompted, input the pairing code and then tap “OK”; or if the pairing code is given automatically, then tap “PAIR”.

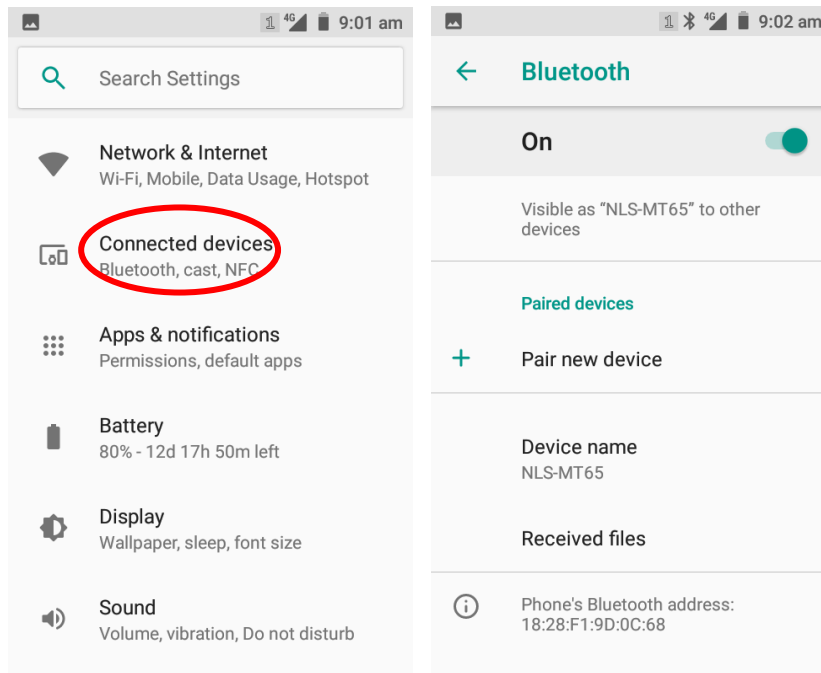

Unpair/rename a paired Bluetooth device: Tap the app icon  then “Connected devices” ->”Bluetooth”, and turn Bluetooth on. Tap “paired device”. To rename the paired Bluetooth device, edit its name manually and then tap “OK”. To unpair it, tap “FORGET”.

Chapter 6 Wi-Fi

Introduction

This chapter describes how to connect the MT65 to a Wi-Fi network.

Wi-Fi Settings

Join a Wi-Fi network:

1. Tap the app icon  -> "Network & Internet"-> "Wi-Fi", and turn Wi-Fi on to find available Wi-Fi networks. If Wi-Fi is already ON, then the terminal will automatically scan for available networks.
2. Tap a network and then enter the password.
3. Tap "CONNECT".

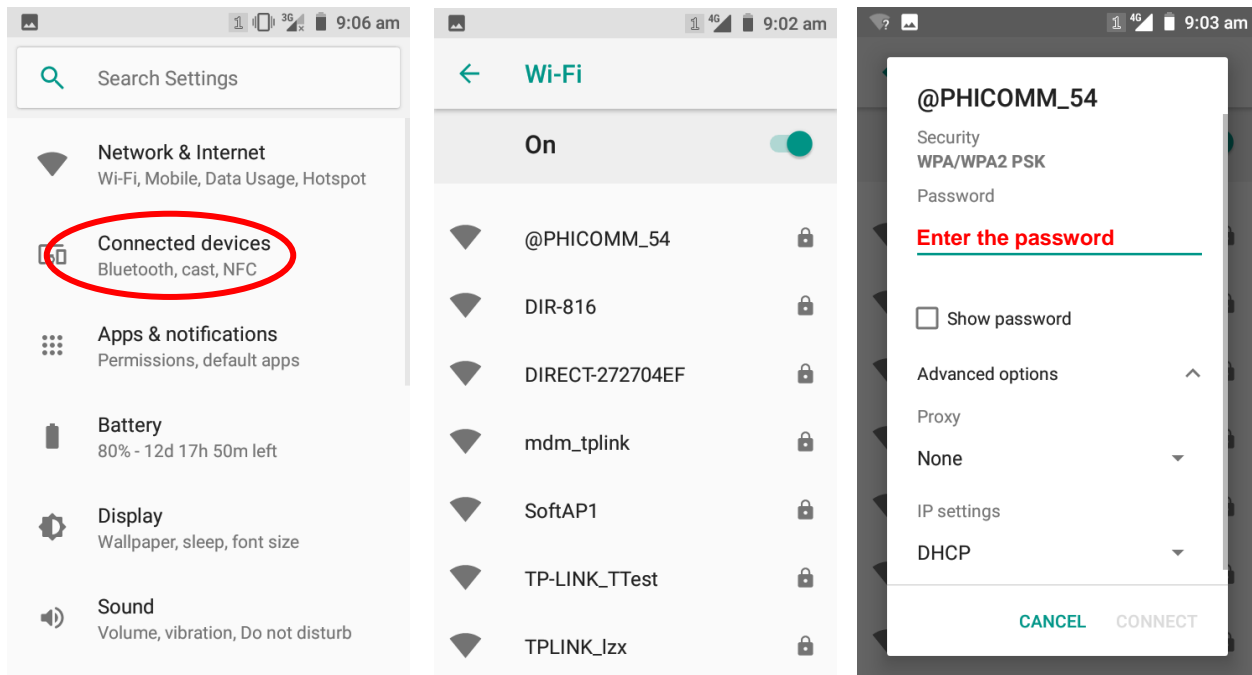

IP Settings

To set the IP, follow the first two steps of joining a Wi-Fi network, check the “Advanced options” item, tap “DHCP” and choose your desired option.

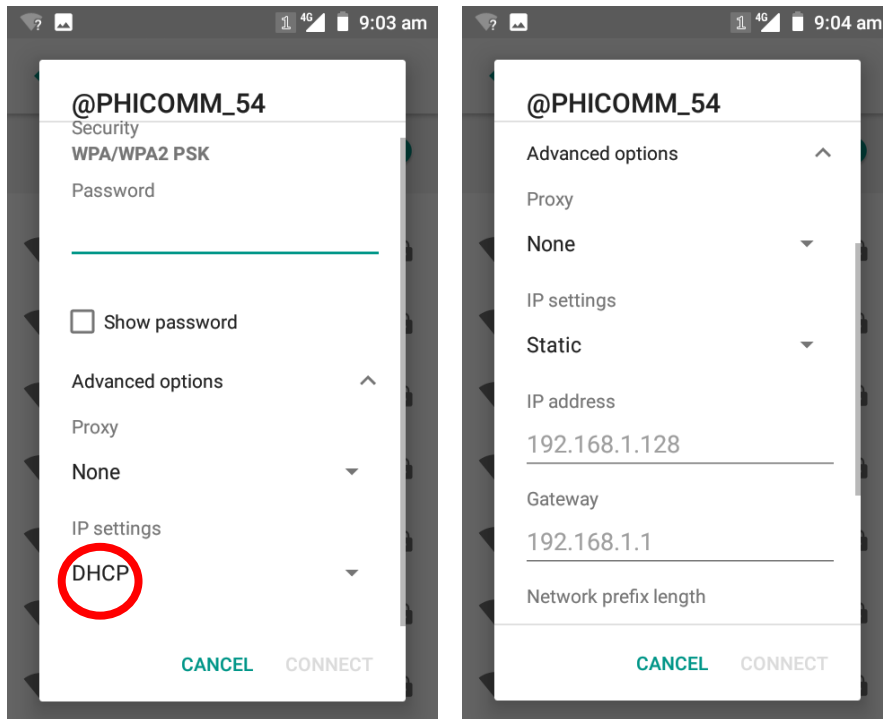

Chapter 7 Mobile Network

Introduction

The MT65 can also use 4G network to connect to the internet. To establish 4G connection, you must have a Micro SIM card installed in your MT65.

Mobile Network Settings

If no Wi-Fi networks are available, or if you've turned Wi-Fi off, then the MT65 connects to the Internet via your cellular data network when available.

Turn on cellular network: Tap  and then turn Cellular data on.

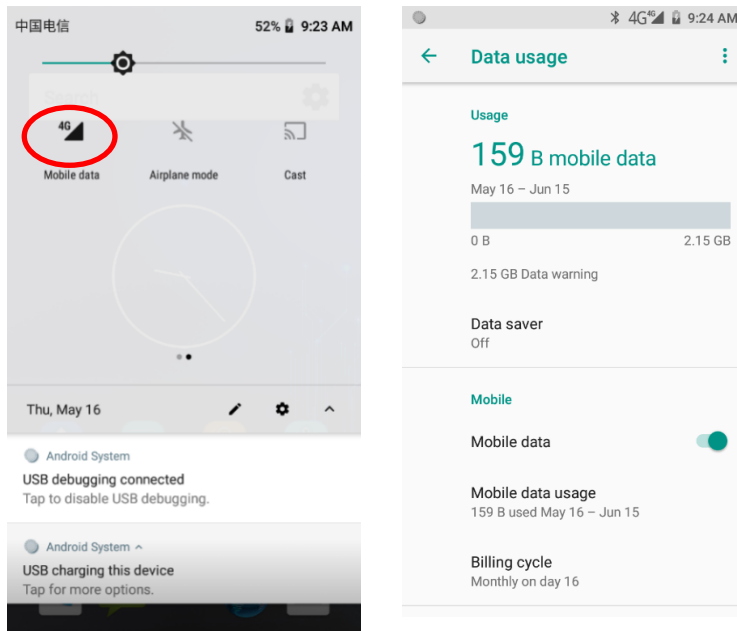

APN Settings

If you cannot connect to the internet when using your terminal's cellular data, you may need to change your APN settings on the MT65 to fix it:

1. Go to Settings -> Network & Internet -> Mobile network -> Access Point Names.

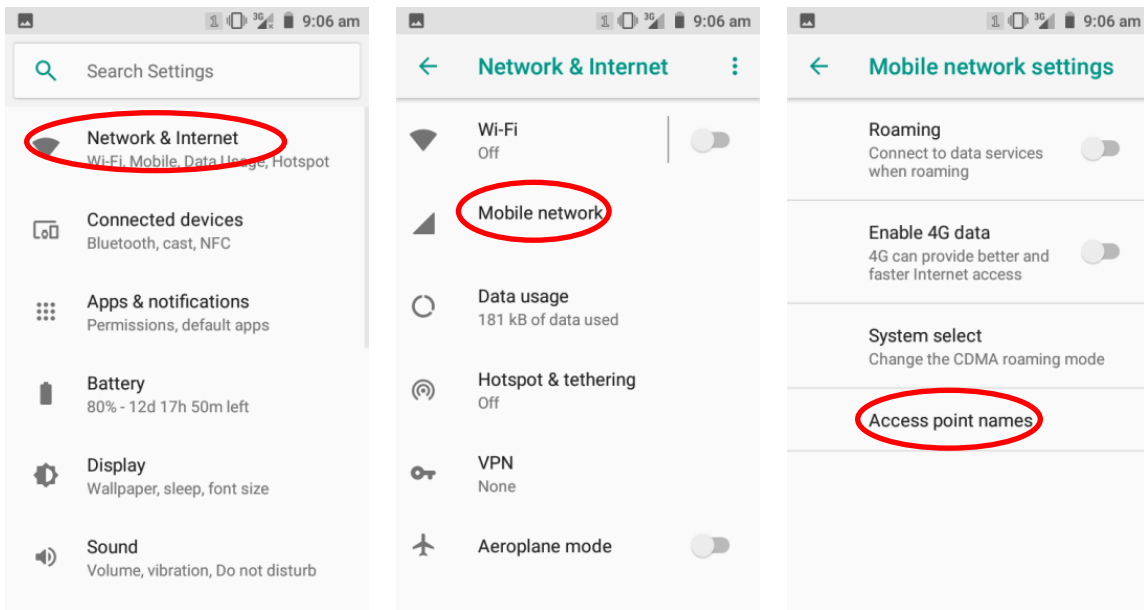

2. Tap  in the top right corner of the screen or tap the carrier of your SIM card on the screen. Then manually enter the APN settings. You can contact your carrier or visit their website to get the correct APN settings, or check the APN settings on a mobile device that can access the internet using the SIM card.

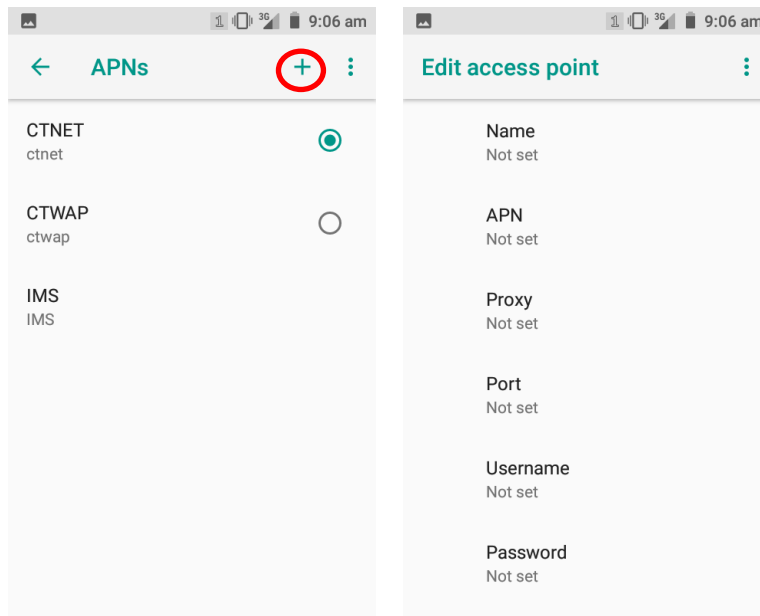



3. Press the Return key on the MT65 to go back to the previous screen and then select the APN you just added.

Chapter 8 Admin Tool

Introduction

The Admin Tool app is used to specify the apps that users can run on the MT65.

Admin Mode Setting

Tap  on the Home screen then  to launch the admin tool and enter the Admin mode. Enter the password (default: 112233).

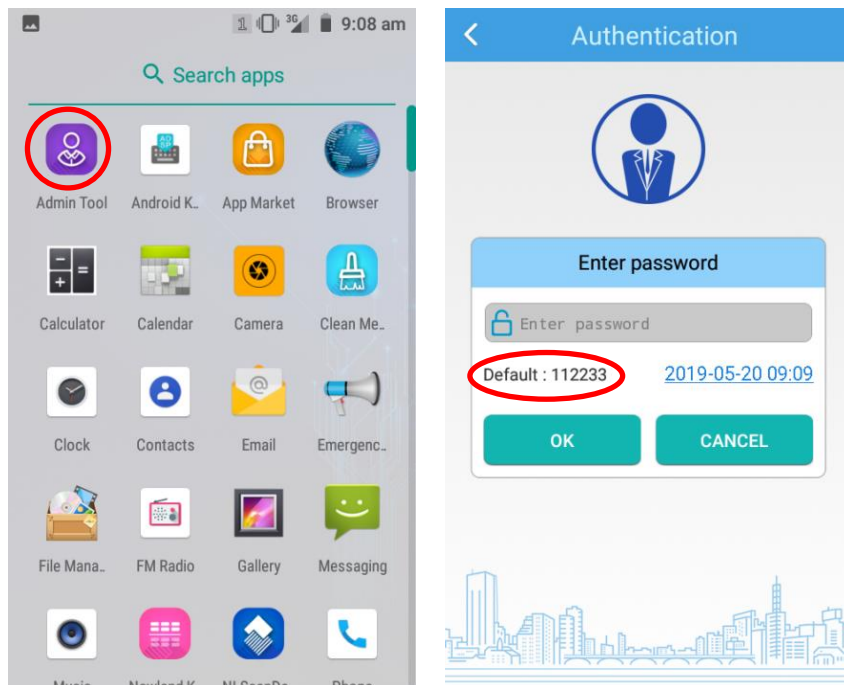

When in the Admin mode, you may set the following parameters as per your actual needs.

1. App Manager: Select or deselect the apps available to normal users.

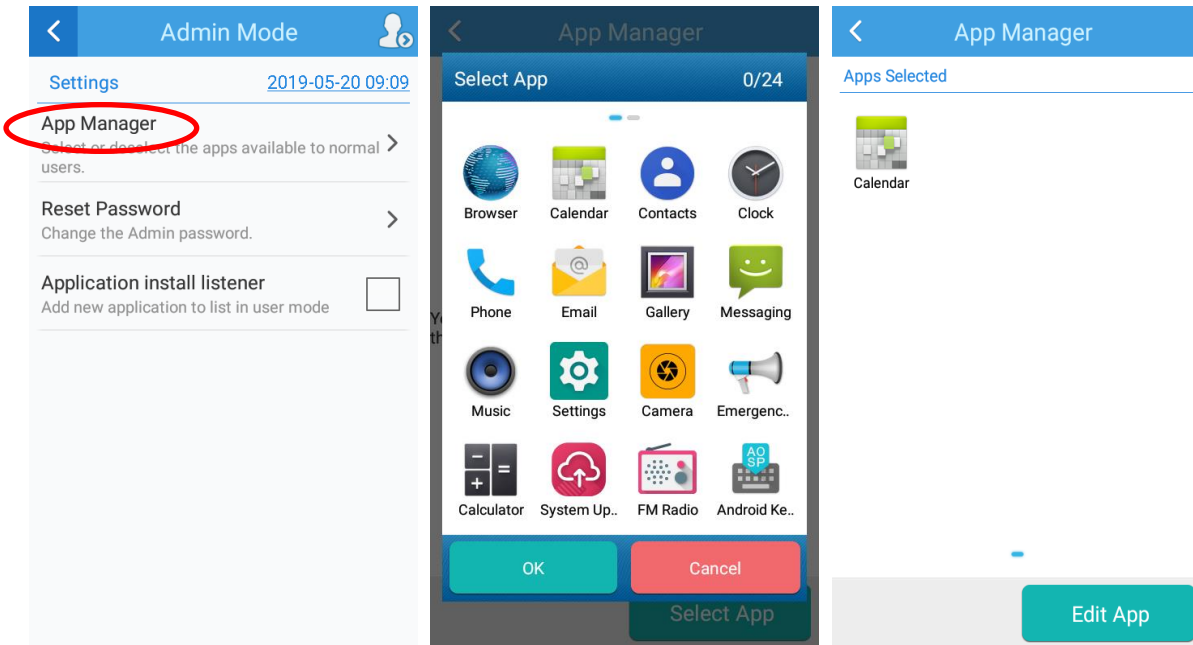

2. Reset Password: Change the Admin password.

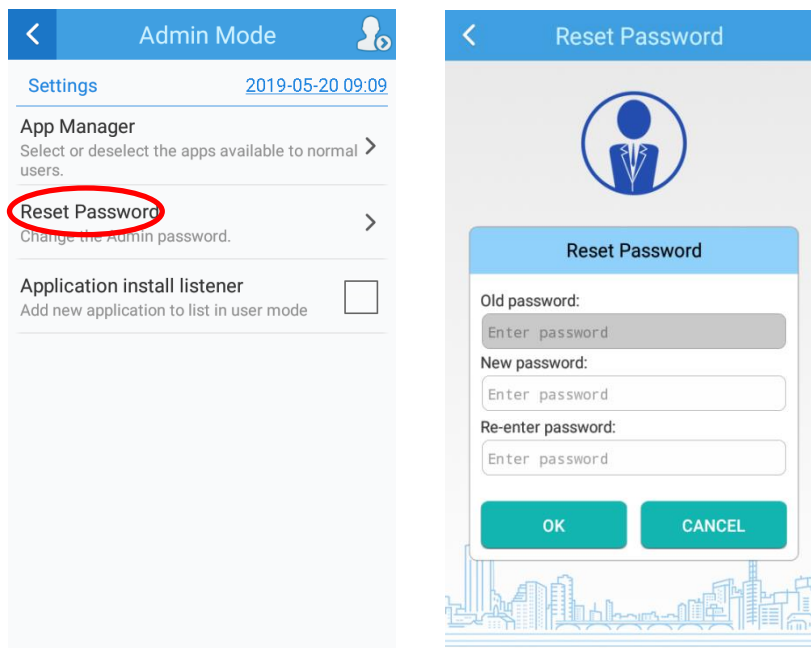

Switching between User Mode and Admin Mode

Enter User Mode: To switch from the Admin mode to the User mode, tap in the top right corner of the screen.

Exit User Mode: Press the Return key on the MT65 and enter Admin Mode password to exit.

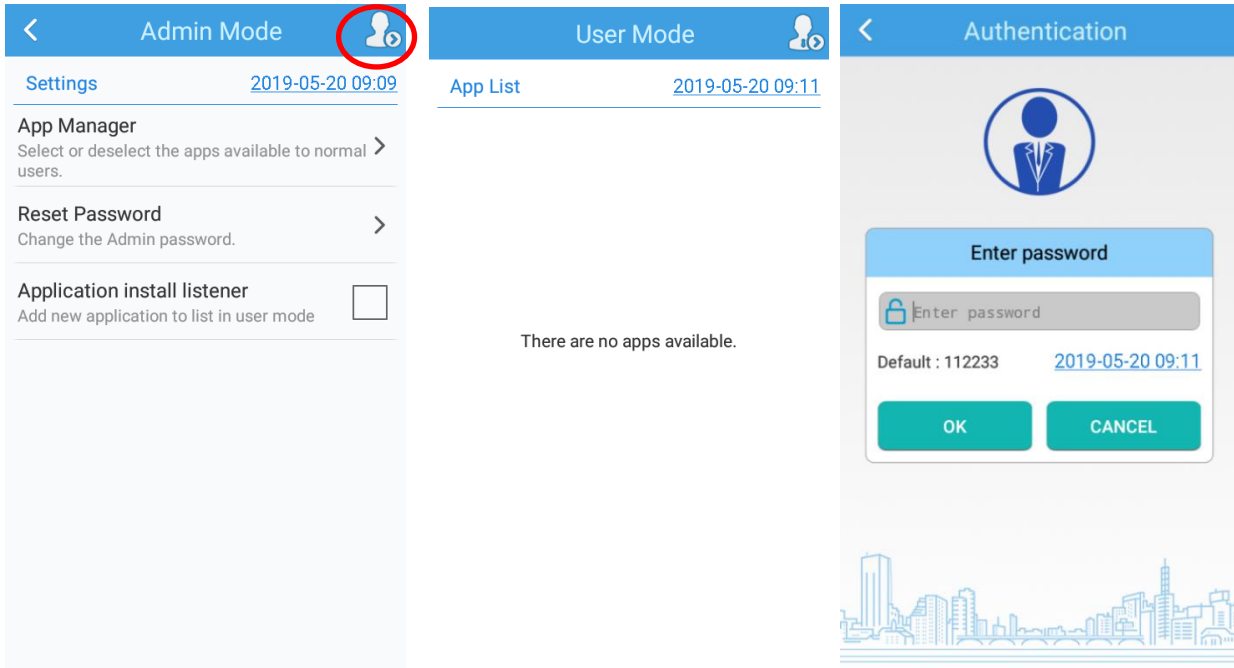



Chapter 9 Whitelist Manager

Introduction

The Whitelist Manager app is used to specify the apps that users can install on the MT65.

Logging in to Whitelist Manager

Tap  “Quick Setting” on the Home screen then , enter the password (default: 112233) and tap “Login” to log in to the whitelist manager. Then set up your Whitelist as per actual needs.

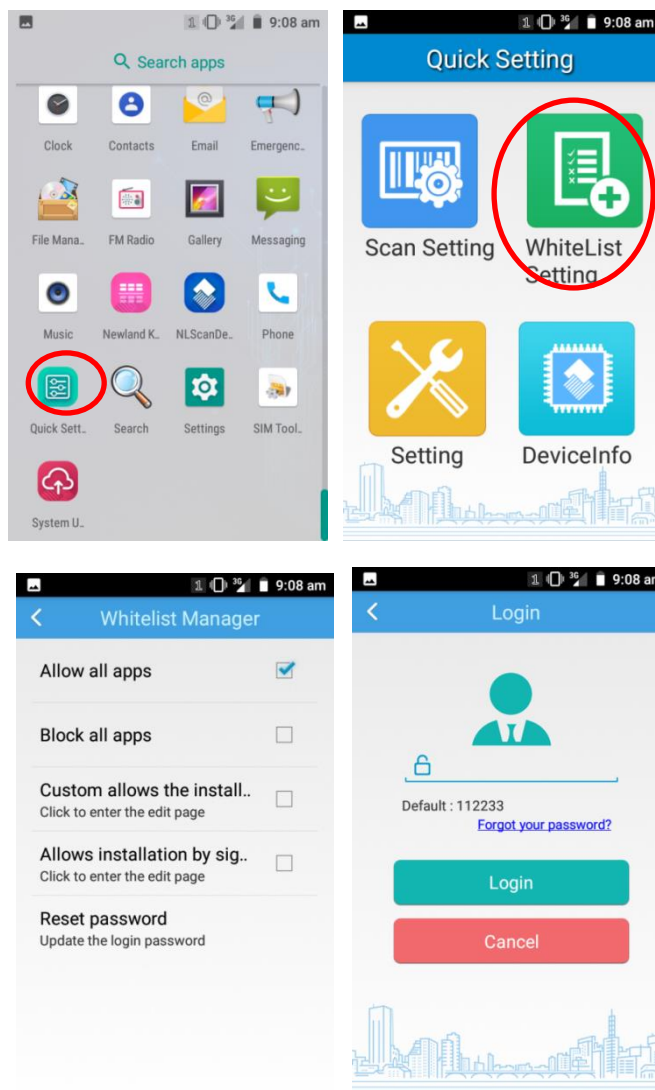

Chapter 10 Others

Camera

Tap the app icon  to launch the Camera app.

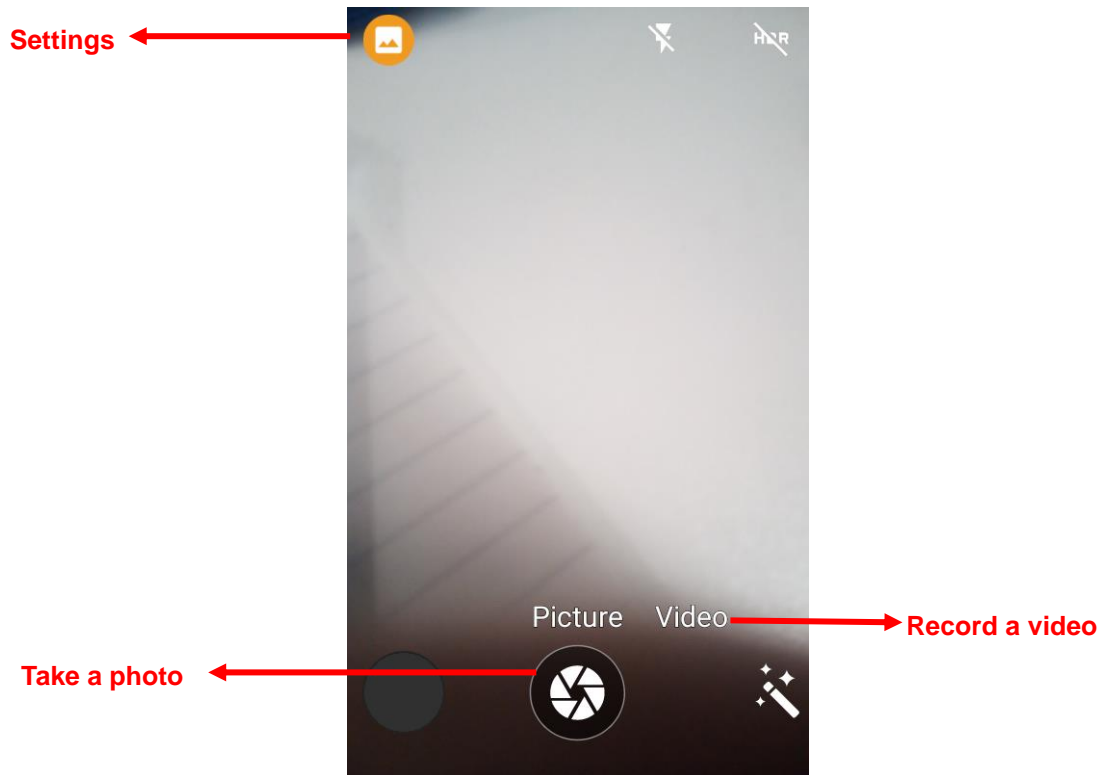

Settings: Tap it to reveal the parameters such as Scene mode, Self timer, Picture size and white balance and set those parameters as per your needs.



: Tap it to take a photo.



: Tap it to start/stop a video recording.



: Tap the thumbnail image in the bottom right corner of the screen to view the photo or video saved.

You can also download a camera app from the Internet or develop an app for the camera feature.

GPS

Tap the app icon  then “Security & Location”, and then:

1. Turn Location on.
2. Tap “Mode” and then choose a location mode as per actual need.
3. Use a third-party map app or other GPS app to obtain location information.

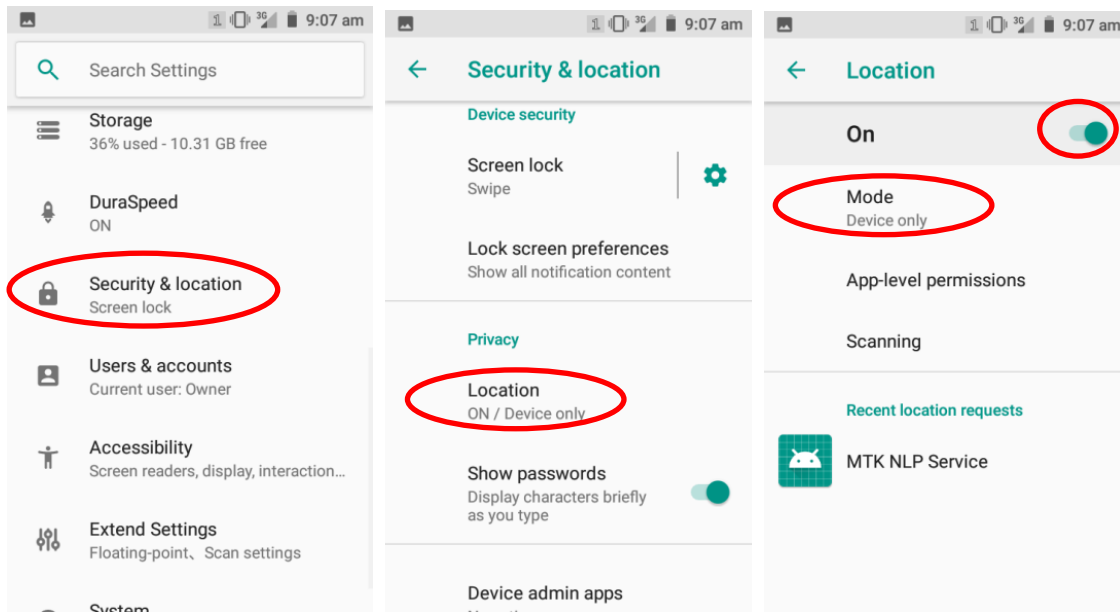

NFC (only for MT65 V Beluga, not available for MT65 Beluga Lite version)

To enable the NFC feature, tap the app icon  -> “Connected devices” -> “NFC”, and then turn on NFC. Then you can install an NFC writer on the MT65 to read and write NFC tags.

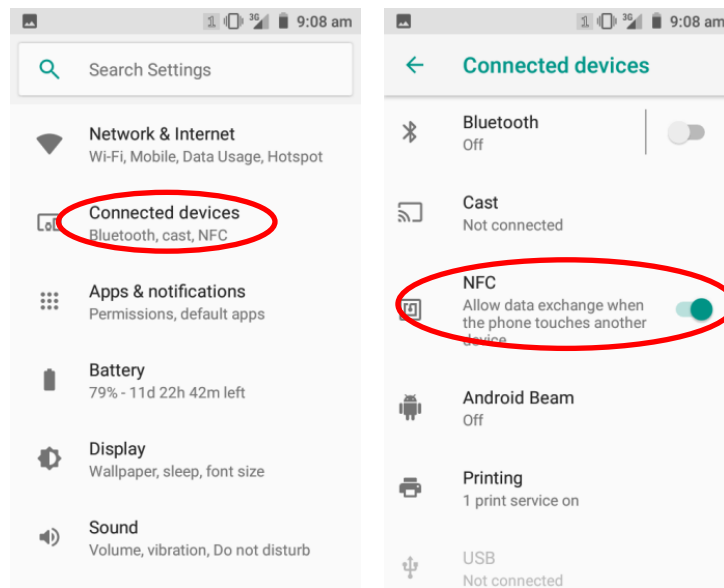

Memory Cleanup

Press and hold the Home key on the MT65 until the terminal displays the following screen and then tap  to clean up the memory.

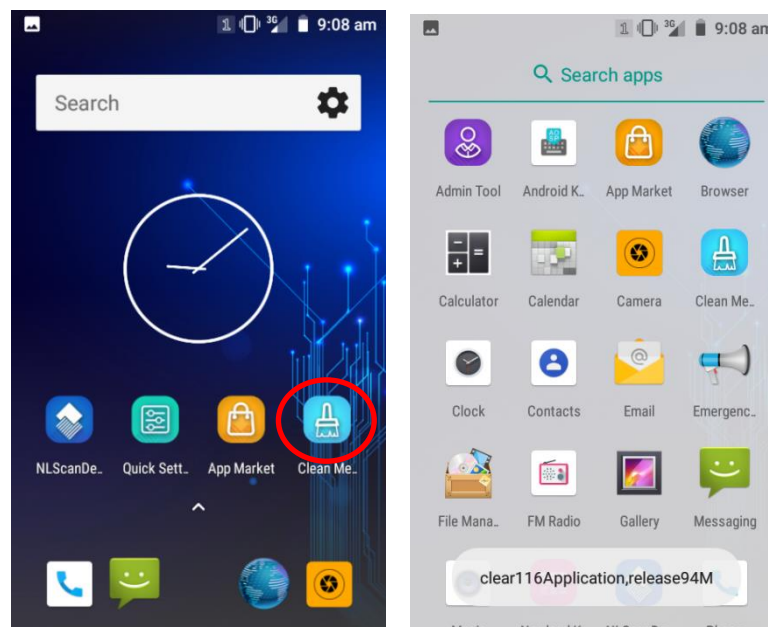

Note: When your terminal becomes less efficiently after having run for extended periods of time, you may perform a memory cleanup or reboot the terminal to fix the problem.

Chapter 11 System Update

Introduction

This chapter introduces two methods to update the system software of the terminal: Online update and local update.

Online Update

Update the system online: Tap  on the Home screen -> "CHECK FOR UPDATES".

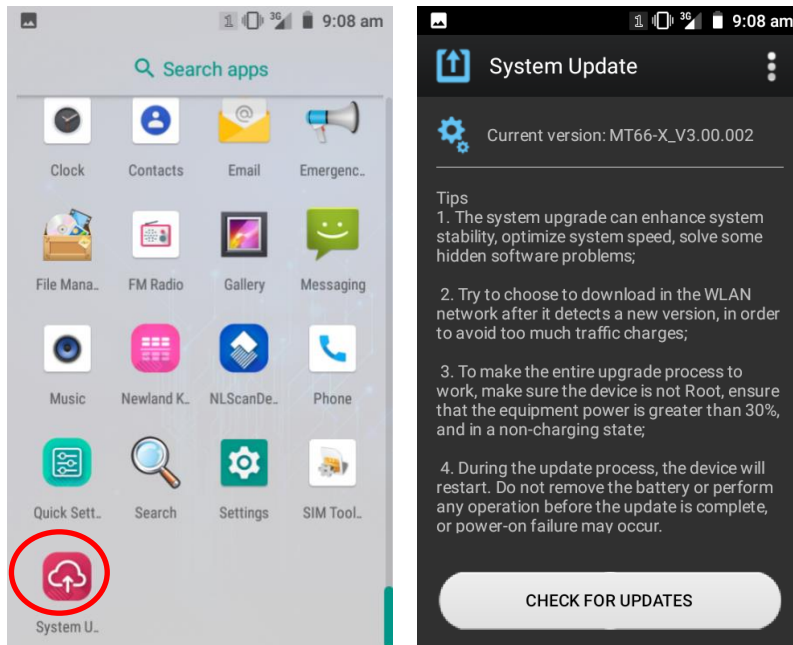

Locate Update

Zip File to the MT65 Drive

1. Connect the terminal to PC with the included USB cable. Swipe from top to bottom with one finger in one smooth motion to open the notification bar. Tap "USB for file transfer". Then Select "Transfer files".

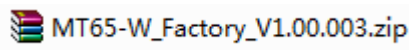

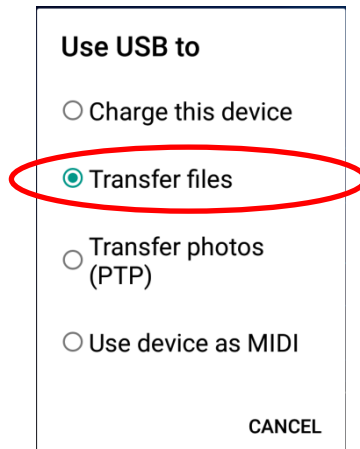

2. Copy the update zip file to the MT65 drive.

3. Tap  on the MT65's Home screen then  to access the System Update screen.

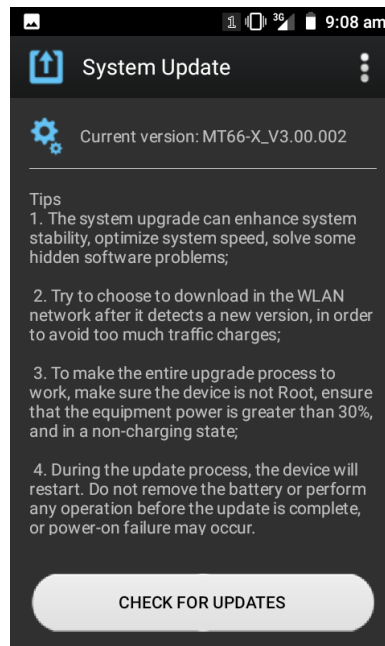

4. Tap  in the top right corner of the System Update screen, and then select "Local Update".

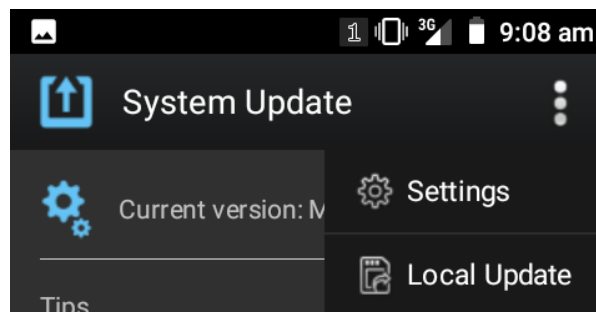

5. Select the update zip file. Then select "NEXTREBOOT" or "UPDATE".

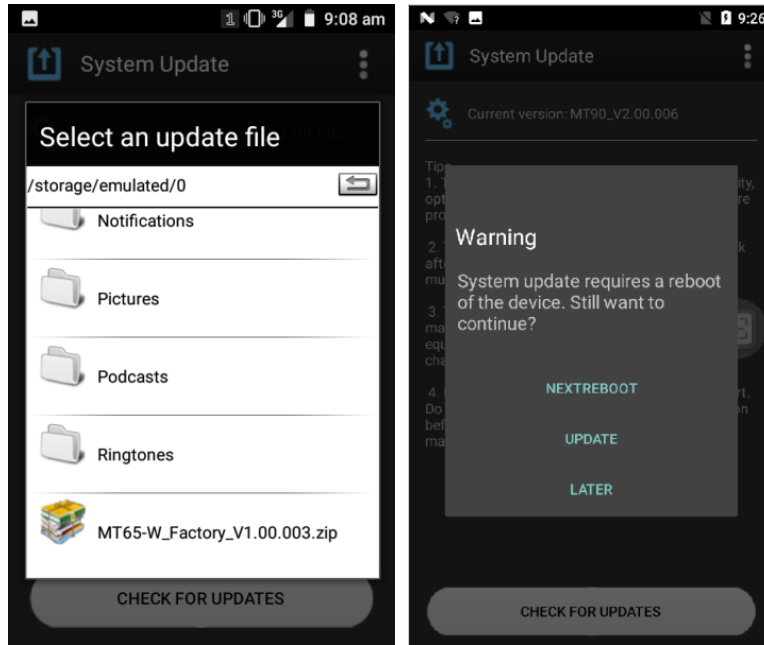

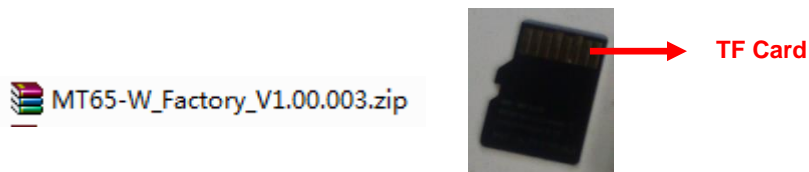

Zip File to TF Card

1. Copy the update zip file to TF Card.



2. Insert the TF card to the MT65 and then power on the terminal.

3. Tap  on the Home screen ->  to access the System Update screen.



4. Tap  in the top right corner of the System Update screen, and then select “Local Update” -> “External Storage”.

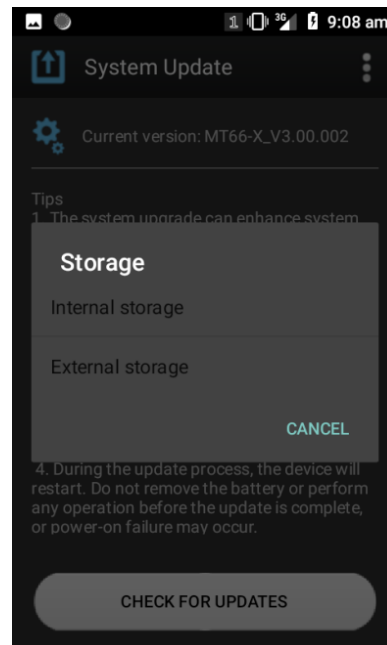
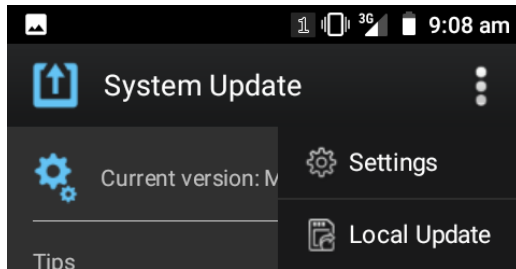

5. Select the update zip file. Then select "NEXTREBOOT" or "UPDATE".

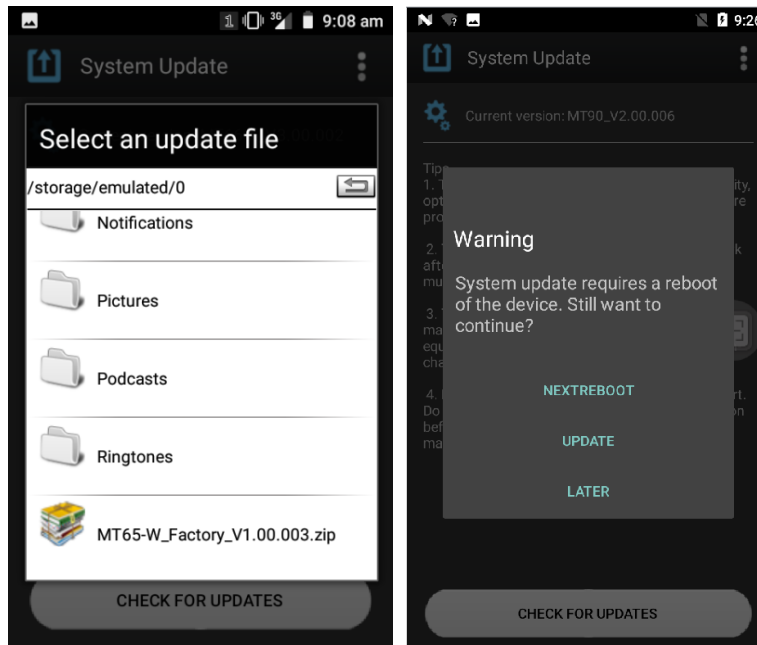

Chapter 12 App Development Guide

Development Environment

The MT65 runs on Android 8.1 operating system, so you should use Android SDK 8.1 or lower when developing apps for the MT65.

Use of Non-standard Interfaces

See **Newland Android PDA API Handbook**.

Chapter 13 Maintenance & Troubleshooting

Introduction

This chapter includes important safety and handling information and provides troubleshooting solutions for issues that might occur when using the terminal.

Important Safety & Handling Information

Disassembly and Retrofit

Do not disassemble or retrofit the terminal by yourself. Unauthorized disassembly or retrofit will void the warranty.

External Power Supply

Use only the included AC adapter. Otherwise there is a risk of damage to the terminal.

Abnormal Situation

Keep the terminal away from fire or heat sources. If there is unusual odor, overheating or smoke during charging, immediately cut off the power and disconnect the AC adapter, and contact your dealer or Newland customer service center. Continued use in this case may result in fire or electric shock.

Drop Damage

If the terminal is damaged due to a drop from high place, immediately cut off the power and contact your dealer or Newland customer service center.

LCD Screen

Do not press against or strike the LCD screen. Otherwise it may damage the screen. When handling a cracked or shattered screen, do not touch the liquid that has leaked from it to avoid skin burn or infection.

Stacking Heavy Objects

Do not place heavy objects on the terminal as those objects may fall and cause injury.

Mounting Location

Do not place the terminal on unstable or uneven surfaces as it may fall and cause injury. Do not expose the terminal to humidity or dust as this may cause fire or electric shock. Do not expose the terminal to direct sunlight for extended periods.

Wireless Functionalities

Do not use the terminal's wireless functionalities where wireless device use is prohibited or where it may cause interference or danger, such as in aircrafts, petrol stations.

Use & Maintenance

- ✧ If the terminal cannot be switched on after experiencing a sudden or unexpected power loss or other abnormalities, remove and then reinstall its battery to reset the terminal.
- ✧ Do not throw, drop or strike the terminal. Doing so may damage the LCD display, interrupt running programs, cause data loss in memory and result in malfunction.
- ✧ Clean the scan window regularly. Do not touch it with hands. Scratched or smudged window may degrade reading performance.
- ✧ Do not tap the touch screen with sharp objects. Doing so may damage the screen or cause internal short circuits.
- ✧ Use only a dry soft cloth to clean the terminal. Cleaning it with wet cloth or benzene/ thinner/ other volatile chemicals may deform and shorten the service life of the keypad and shell of the terminal.
- ✧ Do not place the terminal facedown on any surface, or there might be misoperations.
- ✧ Sudden temperature drops may cause condensation on the shell which could cause malfunction. Care should be taken to avoid condensation. If condensation occurs, dry the terminal before use.

Battery Safety Guidelines

- ✧ **Do not dispose of batteries in a fire as they may explode.**
- ✧ The battery can be charged and discharged over 500 times. If the battery life is unreasonably short, please replace the battery with a new one.
- ✧ Use only the included battery and AC adapter.
- ✧ Do not continue to charge a battery that is fully charged. Overcharging will shorten battery lifespan. If a fully charged battery is not used, it will discharge slowly, which does not affect its normal use.
- ✧ Do not use damaged or faulty AC adapters or batteries.
- ✧ **Properly dispose of and recycle batteries. Do not dispose of them as household garbage.**

Troubleshooting

Problem		Possible Cause & Solution
Type	Description	
Keypad	Unresponsive keypad or incorrect response to any key entry.	This problem may be caused by unreliable cable connection between keypad and mainboard or keypad malfunction. Please contact Newland after-sales service.
Battery	Charging LED is OFF when charging.	Ensure the AC adapter is plugged in properly.
	Noticeably short battery life.	<ol style="list-style-type: none"> 1. Check the battery level. If the battery is almost depleted, recharge it. 2. Replace the battery if it is faulty.
	Fully charged battery is depleted after the terminal is switched on.	If the battery is faulty, replace it with a new one.
USB	USB communication failure	<ol style="list-style-type: none"> 1. Ensure that the USB cable connections are secure. 2. Ensure that there is no contaminant inside the Micro USB port. 3. If the problem still remains, please contact the after-sales service center.
LCD Screen	No display	<ol style="list-style-type: none"> 1. Ensure the terminal is switched on. 2. If the terminal is in sleep mode, press the Power key to wake it up. 3. Check the battery level. If the battery is depleted, recharge it. 4. Ensure that the battery is properly installed. 5. Replace the battery if it is faulty. 6. If the problem still remains, please contact the after-sales service center.
System	Cannot switch on	<ol style="list-style-type: none"> 1. Check the battery level. If the battery is depleted, recharge it. 2. Switch the terminal on after using the included AC adapter to connect it to a power outlet. If the problem disappears, then continue to charge the terminal. If the problem remains after charging the terminal for a while, replace the battery.
	System halted	<ol style="list-style-type: none"> 1. The problem may be caused by bugs of downloaded apps. Ensure that only reliable apps are used. 2. The problem may be caused by a sudden or unexpected power loss. Remove and then reinstall its battery to reset the terminal.

SCANNING MADE SIMPLE

Newland AIDC EMEA
+31 (0) 345 87 00 33
info@newland-id.com

Rolweg 25
4104 AV Culemborg
The Netherlands

