

Bluetooth 2D Ring Scanner

- MS633 Series -



MS633



MS633 LR

User Manual

Version 1.3

Revision History

Date	Change Description	Version
2024/8/29	First Published Version	V1.0
2024/10/1	Add Bluetooth Default Setting	V1.1
2024/10/8	Add Symbologies Default Setting	V1.2
2024/10/16	Delete Serial Number Barcode & Update USB HID Mode	V1.3

Preface

About This Manual

Thank you for purchasing the Unitech product.

This manual explains how to install, operate and maintain our product.

No part of this publication may be reproduced or used in any form, or by any electrical or mechanical means, such as photocopying, recording, or information storage and retrieval systems, without permission in writing from the manufacturer. The material in this manual is subject to change without notice.

Regulatory Compliance Statements

FCC Warning Statement

This device has been tested and found to comply with the limits for a Class B digital device, pursuant to part 15 of the FCC rules. These limits are designed to provide reasonable protection against harmful interference in a residential installation. This equipment generates, uses and can radiate radio frequency energy and, if not installed and used in accordance with the instructions, may cause harmful interference with radio communications. However, there is no guarantee that interference will not occur in a particular installation. If this equipment does cause harmful interference with radio or television reception, which can be determined by turning the equipment off and on, the user is encouraged to try to correct the interference by one or more of the following measures:

- Reorient or relocate the receiving antenna.
- Increase the separation between the equipment and receiver.
- Connect the equipment into an outlet on a circuit different from that to which the receiver is connected.

–Consult the dealer or an experienced radio/TV technician for help.

1. This transmitter must not be co-located or operating in conjunction with any other antenna or transmitter.
2. This device complies with FCC RF radiation exposure limits set forth for an uncontrolled environment. To maintain compliance with FCC RF exposure requirements, avoid direct contact to the transmitting antenna during transmitting.
3. Any changes or modifications (including the antennas) made to this device that are not expressly approved by the manufacturer may void the user's authority to operate the equipment.
4. Operation of transmitters in the 5.925-7.125 GHz band is prohibited for control of or communications with unmanned aircraft systems.

FCC Label Statement

This device complies with part 15 of the FCC rules. Operation is subject to the following two conditions:

1. This device may not cause harmful interference.
2. This device must accept any interference received, including interference that may cause undesired operation.

RF Radiation Exposure Statement

For body contact during operation, this device has been tested and meets FCC RF exposure guidelines when used with an accessory that contains no metal and that positions the handset a minimum of 1.0 cm from the body.

Use of other accessories may not ensure compliance with FCC RF exposure guidelines.

IC Statements

This device complies with Industry Canada licence-exempt RSS standard(s). Operation is subject to the following two conditions:

- (1) This device may not cause interference, and

- (2) This device must accept any interference, including interference that may cause undesired operation of the device.

Le présent appareil est conforme aux CNR d'Industrie Canada applicables aux appareils radioexempts de licence. L'exploitation est autorisée aux deux conditions suivantes :

- (1) l'appareil ne doit pas produire de brouillage, et
(2) l'utilisateur de l'appareil doit accepter tout brouillage radioélectrique subi, même si le brouillage est susceptible d'en compromettre le fonctionnement.

Under Industry Canada regulations, this radio transmitter may only operate using an antenna of a type and maximum (or lesser) gain approved for the transmitter by Industry Canada. To reduce potential radio interference to other users, the antenna type and its gain should be so chosen that the equivalent isotropically radiated power (e.i.r.p.) is not more than that necessary for successful communication.

Conformément à la réglementation d'Industrie Canada, le présent émetteur radio peut fonctionner avec une antenne d'un type et d'un gain maximal (ou inférieur) approuvé pour l'émetteur par Industrie Canada. Dans le but de réduire les risques de brouillage radioélectrique à l'intention des autres utilisateurs, il faut choisir le type d'antenne et son gain de sorte que la puissance isotrope rayonnée équivalente (p.i.r.e.) ne dépasse pas l'intensité nécessaire à l'établissement d'une communication satisfaisante.

- (i) The device for operation in the band 5150-5250 MHz is only for indoor use to reduce the potential for harmful interference to co-channel mobile satellite systems;
- (i) Les dispositifs fonctionnant dans la bande 5150-5250 MHz sont réservés uniquement pour une utilisation à l'intérieur afin de réduire les risques de brouillage préjudiciable aux systèmes de satellites mobiles utilisant les mêmes canaux.

Devices shall not be used for control of or communications with unmanned aircraft systems

Les dispositifs ne doivent pas être utilisés pour commander des systèmes d'aéronef sans pilote ni pour communiquer avec de tels systèmes.

IC Radiation Exposure Statement

This EUT is compliance with SAR for general population / uncontrolled exposure limits in IC RSS-102 and had been tested in accordance with the measurement methods and procedures specified in IEEE 1528 and IEC 62209. This equipment should be installed and operated with minimum distance 10 mm between the radiator and your body. This device and its antenna(s) must not be co-located or operating in conjunction with any other antenna or transmitter.

Cet appareil est conforme aux limites d'exposition DAS incontrôlée pour la population générale de la norme CNR-102 d'Industrie Canada et a été testé en conformité avec les méthodes de mesure et procédures spécifiées dans IEEE 1528 et IEC 62209. Cet appareil doit être installé et utilisé avec une distance minimale de 10mm entre l'émetteur et votre corps. Cet appareil et sa ou ses antennes ne doivent pas être co-localisés ou fonctionner en conjonction avec tout autre antenne ou transmetteur.

European Conformity Statement

Unitech Electronics co., Ltd herewith declares that the Unitech product is in compliance with the essential requirements and all other provisions of the RED 2014/53/EU directive.

The declaration of conformity is available for download at:

<https://portal.Unitech.eu/public/Safetyregulatorystatement>

UK Declaration of Conformity (DoC)

Hereby, Unitech Electronics co., Ltd. declares that the radio equipment type Rugged Handheld Computer is in compliance with UK Radio Equipment Regulations 2017(RER 2017 (SI 2017/1206)).

The full text of the UK declaration of conformity is available at the following internet address: <https://www.ute.com>

UKCA Mark Warning



CE RF Exposure Compliance

For body-worn operation, this device has been tested and meets the ICNIRP guidelines and the European Standard EN 62209-2, for use with dedicated accessories, SAR is measured with this device at a separation of 0.5 cm to the body, while transmitting at the highest certified output power level in all frequency bands of this device. Use of other accessories which contain metals may not ensure compliance with ICNIRP exposure guidelines.

CE Mark Warning



RoHS Statement



This device conforms to RoHS (Restriction Of Hazardous Substances) European Union regulations that set maximum concentration limits on hazardous materials used in electrical and electronic equipment.

Waste electrical and electronic equipment (WEEE)



Unitech has set up a policy and process to meet the 2012/19/EU concerning electronic waste disposal.

For more detailed information of the electronic waste disposal of the products you have purchased from Unitech directly or via Unitech's resellers, you shall either contact your local supplier or visit us at:

<https://portal.Unitech.eu/public/WEEE>

Taiwan NCC Warning Statement

低功率射頻器材技術規範

取得審驗證明之低功率射頻器材，非經核准，公司、商號或使用者均不得擅自變更頻率、加大功率或變更原設計之特性及功能。低功率射頻器材之使用不得影響飛航安全及干擾合法通信；經發現有干擾現象時，應立即停用，並改善至無干擾時方得繼續使用。前述合法通信，指依電信管理法規定作業之無線電通信。低功率射頻器材須忍受合法通信或工業、科學及醫療用電波輻射性電機設備之干擾。

注意事項：

1. 使用過度恐傷害視力。
2. 使用30分鐘請休息10分鐘；未滿2歲以下幼兒不看螢幕，2歲以上每天看螢幕不要超過1小時。
3. 減少電磁波影響，請妥適使用。

Laser Information

The Unitech product is certified in the U.S. to conform to the requirements of DHHS/CDRH 21CFR Subchapter J and to the requirements of IEC 60825-1. Class II and Class 2 products are not considered to be hazardous. The Unitech product contains internally a Visible Laser Diode (VLD) whose emissions do not exceed the maximum limits as set forth in the above regulations. The scanner is designed so that there is no human access to harmful laser light during normal operation, user maintenance or prescribed service operations.

The laser safety warning label required by the DHHS/IEC for the Unitech product's optional laser scanner module is located on the memory compartment cover, on the back of the unit.

* Laser information only applies to the products with laser components.

CAUTION! Use of controls or adjustments or performance of procedures other than those specified herein may result in hazardous laser light. Use of optical instruments with the scanner, including binoculars, microscopes, and magnifying glasses, with will increase eye damage. This does not include eyeglasses worn by the user.

LED Information

The Unitech product contains LED indicator(s) or LED ring whose luminance is not harmful to human eyes during normal operation, user maintenance or prescribed service operations.

*LED information only applies to the products with LED components.

Battery Notice

Performance and Replacement

- For optimal performance, it is recommended to replace rechargeable batteries annually or after 500 charging cycles.
- It's normal for the battery to swell or expand slightly after a year or 500 cycles. This doesn't cause damage but indicates the battery should be replaced and disposed of properly according to local regulations.
- If battery performance drops by more than 20%, it has reached its end of life and should be replaced and disposed of properly.

Battery Life and Conservation

- Battery life depends on the battery type and device usage.
- Avoid fully discharging the battery as this puts stress on it. Several partial charges are better than one full discharge.
- Do NOT expose the battery or device to high temperatures for extended periods, such as in a parked car on a hot day or under direct sunlight. High temperatures can damage the battery. Keep the device within acceptable operating temperatures (refer to the specifications).
- For long-term storage, charge the battery to at least 50% every six months. Leaving the battery uncharged for extended periods will reduce its lifespan.
- If the battery cannot be charged after a long idle period and starts to heat up, do not attempt to charge it. It may be damaged.

Important Cautions

- **Use original batteries only from Unitech.** Using third-party batteries can damage the device and void the warranty.
- **Risk of explosion if the battery is replaced incorrectly.** Dispose of used batteries according to instructions.
- RISK OF EXPLOSION IF BATTERY IS REPLACED INCORRECTLY.
DISPOSE OF USED BATTERIES ACCORDING TO THE INSTRUCTIONS.

- 電池若未正確更換，可能會爆炸。請用原廠建議之同款或同等級的電池來更換，請依原廠指示處理廢電池。
- 請依製造商說明書處理用過之電池，如果更換不正確之電池行事會有爆炸的風險，請依製造商說明書處理用過之電池。

Charging

- Consider temperature when charging. Charging is most efficient at room temperature or slightly cooler.
- Charge batteries within the specified range of 0°C to 40°C (32°F to 104°F). Charging outside this range can damage the battery and shorten its lifespan.
- **Do not charge batteries below 0°C.** This is dangerous and can make the batteries unstable. Use a battery temperature detecting device to ensure safe charging temperatures.

Maintenance and Safety

- Keep all connectors free of contaminants like dust, grease, mud, and water to ensure proper device operation. Neglecting this can cause communication issues, short circuits, or overheating.
- **To clean the battery connectors:**
 - Remove the main battery from the mobile computer.
 - Dip the cotton part of a cotton-tipped applicator in isopropyl alcohol.
 - Gently rub the cotton part of the applicator back and forth across the connectors on both the battery and the device to remove any grease or dirt. Ensure no cotton residue is left on the connectors.
 - Repeat this process at least three times.
 - Use a dry cotton-tipped applicator and repeat steps 3 and 4.
 - Inspect the area for any remaining grease or dirt and repeat the cleaning if needed.
- **To clean the cradle connectors:**
 - Disconnect the DC power cable from the cradle.
 - Dip the cotton part of a cotton-tipped applicator in isopropyl alcohol.

- Rub the cotton part of the applicator along the pins of the connector, moving it back and forth gently from one side to the other. Do not leave any cotton residue on the connector
- Rub all sides of the connector with the applicator
- Remove any lint left by the applicator
- If there is grease or dirt on other areas of the cradle, use a lint-free cloth and alcohol to clean them
- Allow the alcohol to air dry for at least 10 to 30 minutes (depending on the ambient temperature and humidity) before powering on the cradle

CAUTION! *If you clean the battery or cradle connectors with bleach-based chemicals, follow the instructions above to remove any bleach residue from the connectors.*

- If a connector is damaged, have it repaired before using the device to avoid short circuits.
- While charged batteries can be left unused for several months, their capacity may decrease due to internal resistance buildup. They may need recharging before use.
- Store batteries at temperatures between -20°C to 60°C. Higher temperatures can cause faster depletion. Room temperature storage is recommended.
- The above storage information applies only to removable batteries. For devices with non-removable batteries, refer to the product specifications.

Battery Safety Guidelines

- Charge the device in a clean area, away from debris, flammable materials, or chemicals. Take extra care when charging in non-commercial environments.
- Improper battery use can lead to fire, explosion, or other hazards.
- Do not disassemble, open, crush, bend, deform, puncture, or shred the battery.
- Dropping the device can cause the battery to overheat.
- Do not short-circuit the battery or allow metal or conductive objects to touch the battery terminals.
- Do not modify the battery, insert foreign objects, expose it to water or other liquids, or expose it to fire, explosion, or other hazards.
- Do not leave or store the device in hot areas, like parked cars or near heat sources. Do not put the battery in a microwave or dryer.

- Supervise battery usage by children.
- If swallowed, seek medical advice immediately.
- In case of leakage, avoid contact with skin and eyes. If contact occurs, flush the affected area with water for 15 minutes and seek medical advice.
- If you suspect damage to the equipment or battery, contact your service provider for inspection.

Product Operation and Storage Notice

The Unitech product has applicable operation and storage temperature conditions. Please follow the limitation of suggested temperature conditions to avoid failure, damage or malfunction.

**For applicable temperature conditions, please refer to the specification of each product.*

Adapter Notice

1. Please do not leave the power adapter in the socket when it is not connected to your Unitech product for charging.
2. Please remove the power adapter when the battery is fully recharged.
3. The bundled power adapter that comes with your Unitech product is not meant to be used outdoors. An adapter exposed to water or rain, or a very humid environment can cause damage to both the adapter and the product.
4. Please only use the bundled power adapter or same specification of adapter to charge your Unitech product. Using the wrong power adapter can damage your Unitech product.

** The message above only applies to the product connected to the adapter. For the products without using the adapters, please refer to the specification of each product.*

Hearing Damage Warning

To prevent possible hearing damage, do not listen at high volume levels for long periods.



Figure 1 – Warning label (IEC 60417-6044)

Worldwide Support

Unitech's professional support team is available to quickly answer questions or assist with technical-related issues. Should an equipment problem occur, please contact the nearest Unitech regional service representative.

For complete contact information please visit the Web sites listed below:

Taipei, Taiwan – Headquarters Tel: +886-2-89121122 E-mail: info@hq.ute.com Address: 5F, No. 136, Lane 235, Baoqiao Road, Xindian District, New Taipei City 231, Taiwan (R.O.C.) Website: http://www.ute.com	Europe Tel: +31-13-4609292 E-mail: info@eu.ute.com Address: Kapitein Hatterasstraat 19, 5015 BB, Tilburg, the Netherlands Website: http://eu.ute.com
China Tel: +86-59-2310-9966 E-mail: info@cn.ute.com Address: Room401C, 4F, RIHUA International Mansion, Xinfeng 3rd Road, Huoju Hi-tech District, Xiamen, Fujan, China Website: http://cn.ute.com	Japan Tel: +81-3-62310896 E-mail: info@jp.ute.com Address: Tosei Building 3F.,18-10 Nihonbashi-Hakozakicho, Cyuouku, Tokyo, 103-0015, Japan Website: http://jp.ute.com
Asia & Pacific / Middle East Tel: +886-2-27911556 E-mail: info@apac.ute.com info@india.ute.com info@mideast.ute.com Address: 4F., No. 236, ShinHu 2nd Rd., NeiHu Chiu, 114, Taipei, Taiwan Website: http://apac.ute.com / http://mideast.ute.com	Latin America Tel: +52-55-5171-0528 E-mail: info@latin.ute.com Address: 17171 Park Row, Suite 210 Houston, TX 77084USA (Rep.) Website: http://latin.ute.com
North America Tel: +1-714-8916400 E-mail: info@us.ute.com / info@can.ute.com Address: 6182 Katella Ave, Cypress, CA 90630, USA Website: http://us.ute.com	Please scan QRCode to visit us: 

Warranty Policy

The following items covered under the Unitech Limited Warranty are free from defects during normal use:

The warranty period is varied from each country. Please consult with your supplier or Unitech local office for actual length of warranty period to your purchased product.

Warranty becomes void if equipment is modified, improperly installed or used, damaged by accident or neglect, or if any parts are improperly installed or replaced by the user.

Table of Contents

Preface	i
Regulatory Compliance Statements	i
Laser Information	viii
LED Information	viii
Battery Notice	ix
Adapter Notice	xii
Hearing Damage Warning	xiii
Worldwide Support	xiv
Warranty Policy	xv
Chapter 1 - Overview	1
1.1 Package	1
1.2 Product Detail	2
1.3 Specifications	5
1.4 Getting Started	8
Chapter 2 – Command Setting	12
2.1 Pairing for The First Time Use	12
2.2 Bluetooth Keyboard Configure	12
2.3 Bluetooth SPP Mode	13
2.4 Bluetooth BLE Mode	14
2.5 USB Keyboard Configure	16
2.6 USB VCP Mode	17
2.7 Trigger Mode	18
2.8 Suffix Settings	19
2.9 Offline Storage Mode	20
2.10 Hardware Information	22
2.11 Vibration Level	23
2.12 Factory Setting	24

Chapter 3 – Symbology	25
3.1 UPC/EAN/JAN.....	25
3.2 Code 39.....	52
3.3 Code 93.....	59
3.4 Code 11.....	61
3.5 Interleaved 2 of 5 (ITF).....	64
3.6 Discrete 2 of 5 (DTF).....	74
3.7 Codabar (NW - 7).....	76
3.8 MSI.....	82
3.9 Chinese 2 of 5.....	86
3.10 Matrix 2 of 5.....	87
3.11 Inverse 1D.....	90
3.12 GS1 DataBar.....	91
3.13 Symbology-Specific Security Features.....	95
3.14 Composite.....	99
3.15 2D Symbologies.....	103
3.16 Macro PDF Features.....	114
3.17 Set Barcodes Enable/Disable.....	125
3.18 Parameter Barcode Scanning.....	125
3.19 Lock/Unlock Parameter Scanning.....	126
3.20 Validate Concatenated Parameter Barcodes.....	127
3.21 OCR-A.....	127
3.22 OCR-A Variant.....	128
3.23 OCR-B.....	129
3.24 OCR-B Variant.....	129
3.25 MICR E13B.....	133
3.26 US Currency Serial Number.....	134
3.27 OCR Orientation.....	134
3.28 OCR Lines.....	135
3.29 OCR Minimum Characters.....	136
3.30 OCR Maximum Characters.....	136
3.31 OCR Subset.....	137
3.32 OCR Quiet Zone.....	137

3.33 OCR Template	138
3.34 OCR Check Digit Modulus.....	152
3.35 OCR Check Digit Multiplier	153
3.36 OCR Check Digit Validation	154
3.37 Inverse OCR.....	161
3.38 OCR Redundancy	162
A-1 ASCII Character Set	163
A-2 Extended Key Character Set	168
B-1 Extended Key Character Set	169
B-2 Cancel	170
C-1 Alphanumeric Barcodes	171
D-1 Symbol Code Identifiers	178
D-2 AIM Code Identifiers	180

Chapter 1 - Overview

1.1 Package

Please make sure the following contents are in the MS633 / MS633 LR gift box. If something is missing or damaged, please contact your Unitech representative.

The Package Contents

- MS633 / MS633 LR Scanner
- 600 mAh Battery
- USB-C Cable

Accessories

- 600mAh Battery
- Finger Holder
- USB Type-C cable
- Power Adapter

1.2 Product Detail

MS633 Product View

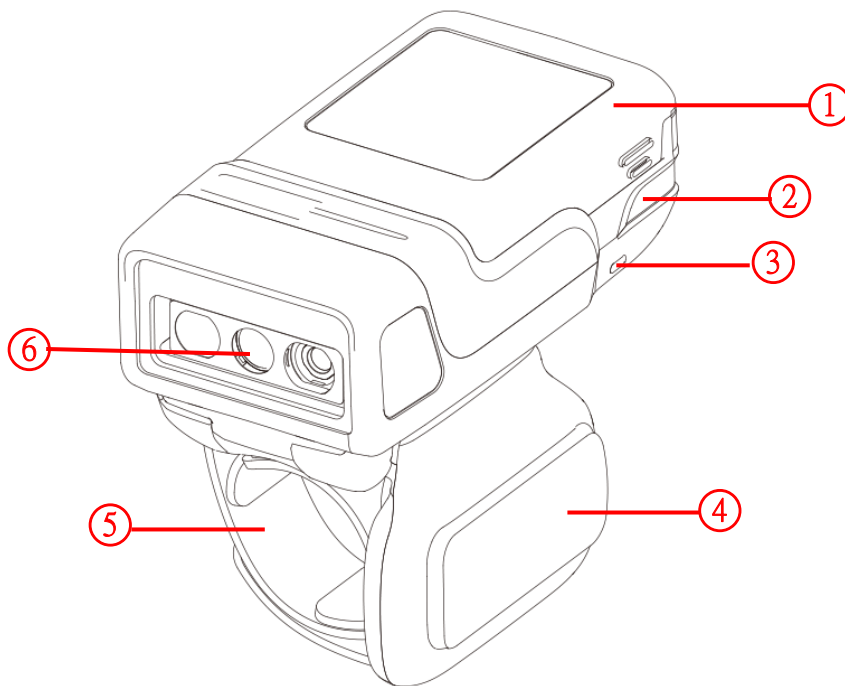

- 1. Battery
- 2. LED Indicators
- 3. Buzzer

- 4. Trigger Button / Power Button
- 5. Strap
- 6. Engine Window

MS633 LR Product View

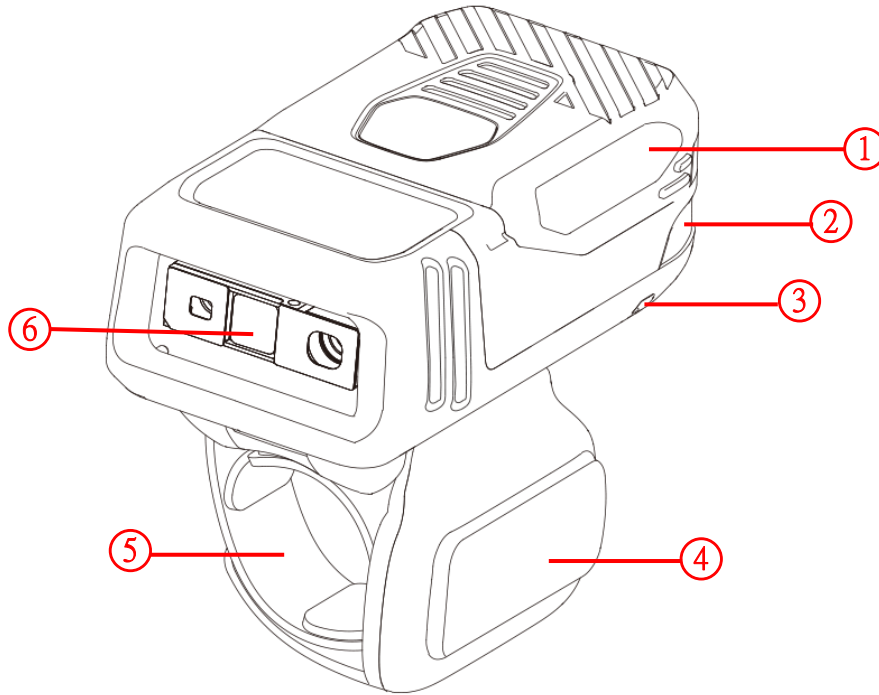

- | | |
|-------------------|----------------------------------|
| 1. Battery | 4. Trigger Button / Power Button |
| 2. LED Indicators | 5. Finger Ring Strap |
| 3. Buzzer | 6. Engine Window |

MS633 Rear View

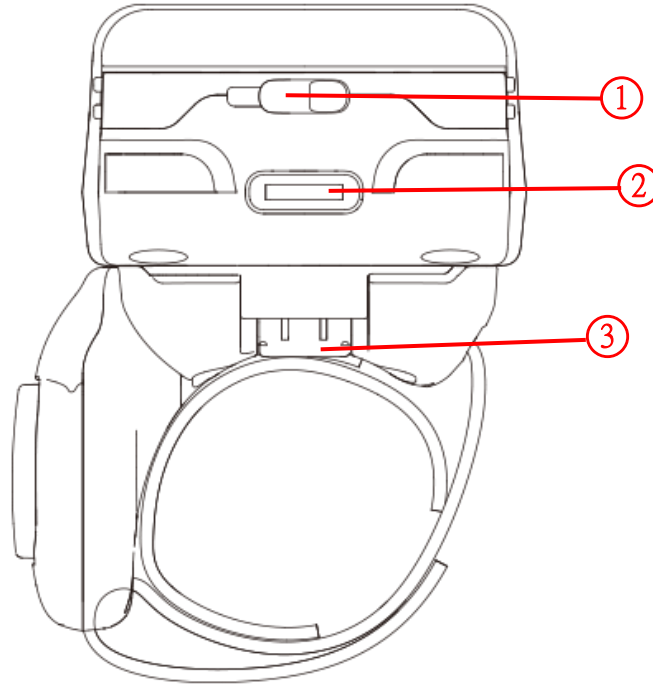

1. Battery Latch
2. USB-C Connector
3. Finger Ring Strap Latch

1.3 Specifications

Optical & Performance	
Sensor	MS633: CMOS Image (1280 x 960 pixels) MS633 LR: CMOS Image (2688 x 1520 pixels)
Aiming Element	Green Laser
Illumination	MS633: 1 Warm-White LED MS633 LR: 2 Warm-White LED
Ambient Light	Max 107,639 lux (direct sunlight)
Skew Angle	±60°
Pitch Angle Sensor	±60°
Roll Angle	360°
Field of View	MS633: 44.5° horizontal, 33.5° vertical MS633 LR: 37° horizontal , 21° vertical
Depth of Field	MS633: 5mil Code39: 6.1cm~24.1cm/2.4in.~9.5in. 5mil Code128: 7.1cm~22.9cm/2.8in.~9.0in. 6.67mil PDF417: 6.1cm~20.3cm/2.4in.~8.0in. 10mil DataMatrix: 7.4cm~21.6cm/2.9in.~8.5in. 100% UPCA: 4.6cm~49.5cm/1.8in.~19.5in. 15mil QR Code: 3.0cm~29.2cm/1.2in.~11.5in. 20mil QR Code: 3.0cm~35.6cm/1.2in.~14.0in.
Depth of Field	MS633 LR: 3mil Code 39: 6.9cm~41.1cm/2.7in.~16.2in. 5mil Code 39: 6.4cm~67.6cm/2.5in.~26.6in. 5mil PDF417: 7.1cm~49.8cm/2.8in.~19.6in. 6.7mil PDF417: 6.6cm~65cm/2.6in.~25.6in. 10mil DataMatrix: 5.6cm~68.8cm/2.2in.~27.1in. 100% UPC(13mil): 6.4cm~180cm/2.5in.~71in. 15mil Code 128: 18.2cm~182.9cm/7.2in.~72in. 200mil DataMatrix: 20cm~1440cm/7.9in.~566.9in. 200mil QR: 25cm~1800cm/9.8in.~708.7in.

Regulatory Approvals	
CE, FCC, TELEC, NCC, BSMI, RoHS	
Communication	
Radio	Bluetooth® HID Keyboard, SPP and BLE
Wireless Coverage	> 164.04ft./50m (without obstructions)
Host Interface supported	USB Type-C (USB HID Keyboard, USB VCP (Virtual Serial Port))
Mechanical	
Dimension	MS633: 64.8mm(L)×34.5mm(W)×24.7mm(D) MS633 LR: 70.0mm(L)×36.4mm(W)×28.4mm(D)
Weight	MS633: 56g / MS633 LR: 67g
Trigger Switch Life	500,000 times
Symbologies	
1D Barcodes	Code39, Code128, Codabar, Code11, UPC/EAN, 2of5 Databar, Code39, MSI, UK Plessy, Telepen, Composite, TLC-39
2D Barcodes	Postal Codes, PDF, Micro PDF, Composite, TLC-39, Aztec, Data Matrix, QR, Maxicode, Han Xin, Grid Matrix, OCR
Electrical	
Indicator	LED, Buzzer, Vibration
Battery Capacity	600mAh
Battery Charging time	2hrs.
Operating Time	9hrs.
Environmental	
ESD Protection	Functional after 4K Contact and 8K Air
Mechanical Shock	Multiple 4.9 ft./1.5 m drops to concrete over the operating temperature range
Operating Temperature	14°F ~ 122°F / -10°C~50°C
Storage Temperature	14°F ~ 122°F / -10°C~50°C
Relative Humidity	5% to 85% non-condensing

Accessories

- Power Adapter
- Finger Holder
- USB-C Cable
- 600mAh Battery

1.4 Getting Started

1.4.1 Install the Trigger of MS633 / MS633 LR

Determine whether the ring scanner is intended for use on the right or left hand, and rotate the trigger assembly accordingly. Position the trigger next to the thumb when the ring scanner is placed on the index finger. Align and insert one end of the finger ring strap into the strap slot, then push the other end down until it snaps into place.

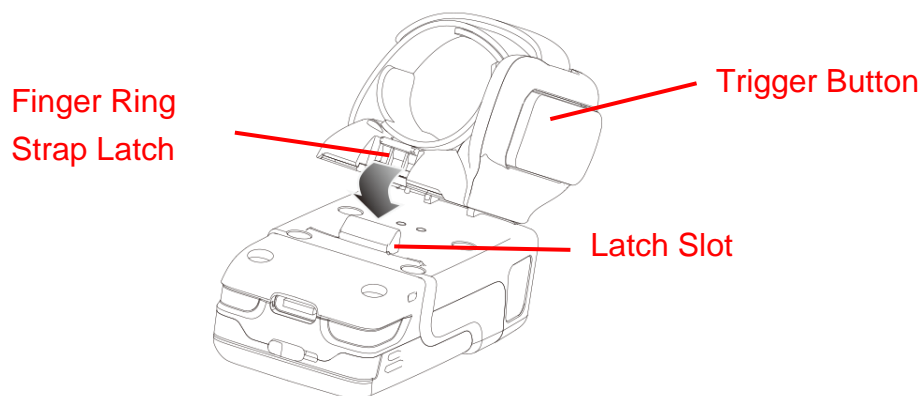
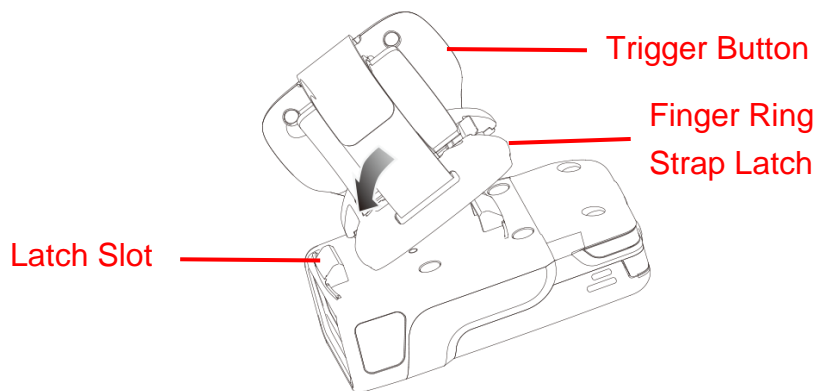

1.4.2 Removing the Trigger of MS633

Press the finger ring strap latch inward and pull the entire strap outward to remove it.

1.4.3 Install the Battery

1. Align the battery with the slots of the MS633 / MS633 LR battery compartment.

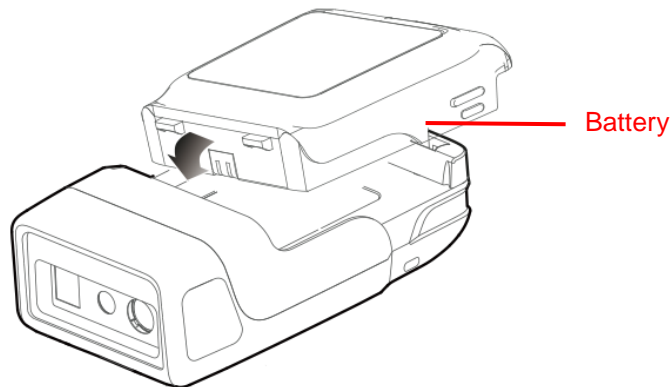

2. Press the battery into the battery compartment.

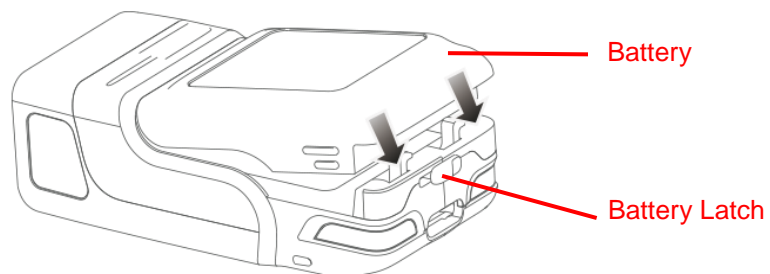

1.4.4 Remove the Battery

To remove the battery, slide the battery latch to the left, then grasp both sides of the battery and pull it upward to remove it.

1.4.5 Charging the Battery

Please use the USB-C cable included in the MS633 / MS633 LR packaging for charging.

The charging steps for the MS633 / MS633 LR are as follows:

- ① Connect the USB-C cable to the USB-C port on the MS633.
- ② Attach the other end of the cable to the AC power adapter.
- ③ Plug the AC power adapter into a power outlet.

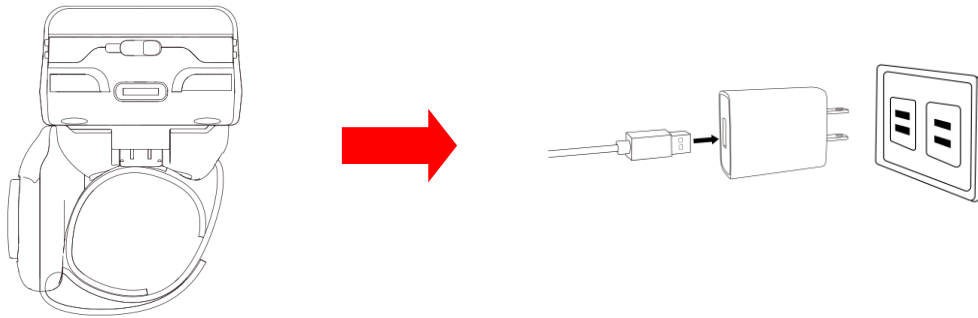

1.4.6 Checking LED Status of the MS633 / MS633 LR

LED	Status
Green LED blinks one time	Decode Successfully
Green LED is blinking continuously	Low Battery Alarm
Red LED turns on	Charging
Red LED turns off	Fully Charged
Blue LED is blinking continuously	Start Bluetooth Pairing

1.4.7 Turn On / Off the MS633 / MS633 LR

Turn ON the scanner after pressing and holding scanner's trigger button for 1.5 seconds.

Turn OFF the scanner after pressing and holding scanner's trigger button for 5 seconds.

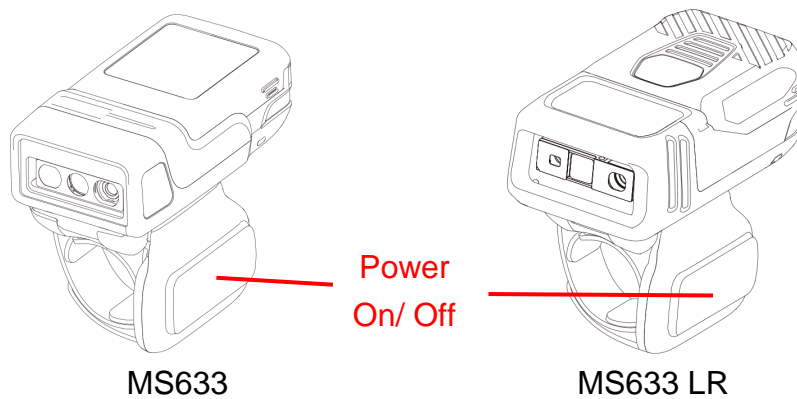

1.4.9 Scanning Techniques

Please aim the red light at the middle of the barcode when scanning the barcode. Please scan properly in accordance with the following diagram. Adjust the scanner's angle and distance slowly, while simultaneously pressing the trigger button to ensure that **the center red light covers both the left and right sides of the barcode.**

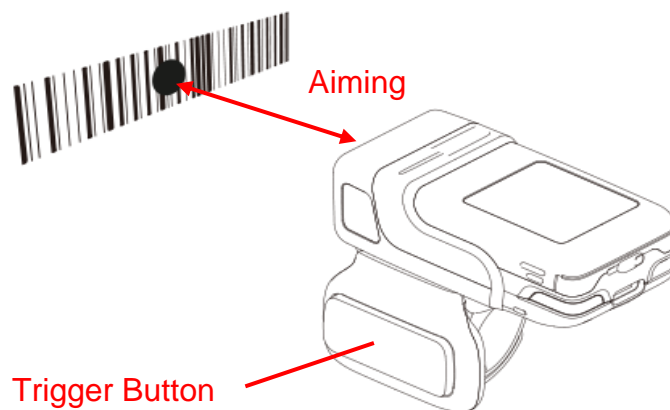

Chapter 2 – Command Setting

2.1 Pairing for The First Time Use

2.1.1 Pairing with Mobile Devices

Step 1. Go to your host device settings and turn the Bluetooth function on.

Step 2. The MS633 / MS633 LR will appear on your device as “**MS633XXXX**” and select it.

Step 3. Open a word processing program such as Microsoft Word or Notepad and scan the following barcode. If the word 'Unitech' appears on the screen, you have successfully installed your scanner.



2.2 Bluetooth Keyboard Configure

2.1.1 Bluetooth HID Mode

The Bluetooth HID mode functions as a Bluetooth keyboard. When you scan the barcode below, the data will be output at the cursor. If the MS633 / MS633 LR pairs successfully, its LED will blink rapidly in blue.

Bluetooth HID Mode*



When the connection is successfully completed, the device's blue light will turn off.

2.3 Bluetooth SPP Mode

The Bluetooth SPP mode is a Bluetooth serial port. You need a Bluetooth serial port software for data transmission. The SPP mode can also use the serial port software to send commands to the scanner.

Please scan the Bluetooth SPP Mode barcode below. If the MS633 / MS633 LR pairs successfully, its LED will blink slowly in blue.

Bluetooth SPP Mode



Step 1. Please click '**Connect Scanner**'.



Step 2. Please click '**Bluetooth Scanner**'.



Step 3. Please click '**Go select**'.



Step 4. Choose your '**Barcode Scanner**'.

Unitech-BarcodeScanner BT4.2(LE)
DC:0D:30:BB:1F:36

Step 5. Enter PIN '**1234**' and click next step.



Step 6. You will be able to see your data on your device.

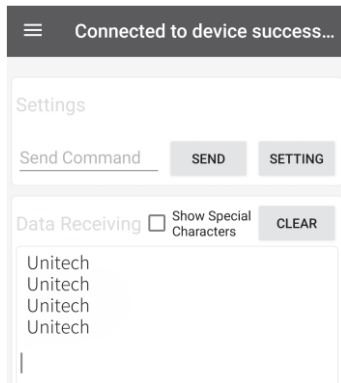

2.4 Bluetooth BLE Mode

The Bluetooth BLE mode is a Low Energy protocol introduced with Bluetooth 4.0. BLE software is required for data transmission. This mode enables the software to send commands to the scanner.

Please scan the Bluetooth BLE Mode barcode below. If the MS633 / MS633 LR pairs successfully, the LED will blink twice quickly, followed by one slow blink.

Bluetooth BLE Mode



Step 1. Please click '**Connect Scanner**'.



Step 2. Please click '**Bluetooth Scanner**'.



Step 3. Please click '**Go select**'.



Step 4. Choose your '**Barcode Scanner**'.

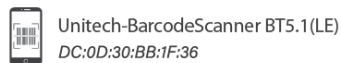

Step 5. You will be able to see your data on your device.

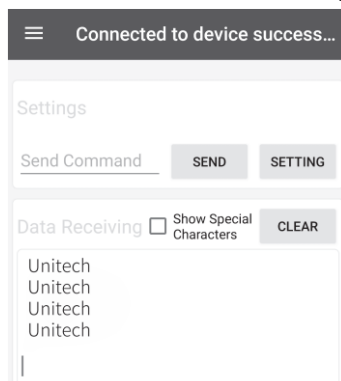

2.5 USB Keyboard Configure

2.5.1 USB HID Mode

The USB HID mode functions as a USB keyboard. When you scan the barcode below, the data will be output at the cursor.

USB HID Mode



Then connect your device to your computer with the USB cable that comes in the box.

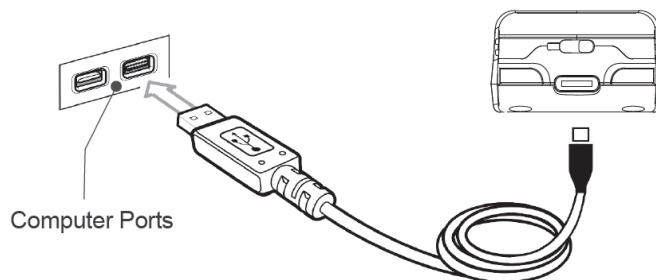

When MS633 / MS633 LR successfully connects, you will hear 3 beeps from the scanner. After that, you can open a word processing program such as Microsoft Word or Notepad on your computer to display the scanned data.

You can scan the following barcode as an example. You will see the word 'Unitech' appears on the screen.



2.6 USB VCP Mode

You can activate VCP (Virtual COM Port) Mode by scanning the barcode below.

USB VCP Mode



PARAMETERS

Baudrate 9600
Data Bits 8
Flow Control N
Stop Bits 1

2.7 Trigger Mode

Scan one of the following bar codes to select a trigger mode for the engine:

Disable Auto Trigger*



1 Second Auto Trigger



2 Second Auto Trigger



5 Second Auto Trigger



2.8 Suffix Settings

You can Enable or Disable the suffix by scanning the following barcodes. The default suffix is CR and LF.

Disable Suffix



Enable Suffix*



2.8.1 Special Suffix Settings

You can change the suffix by scanning the following barcodes.

CR LF*



CR



LF



TAB



SPACE



2.9 Offline Storage Mode

The Offline Storage Mode stores scanned barcodes in the scanner when Bluetooth is not connected, allowing them to be uploaded uniformly later. You can enable or disable this mode by scanning the following barcodes.

Enable Offline Storage Mode



Disable Offline Storage Mode*



You can get the number of stored barcodes, clear the stored records, and upload barcodes at different speeds by scanning the barcodes on the next page.

Fast Speed Upload



Middle Speed Upload



Low Speed Upload



Barcode Storage Information



Clear Barcode Storage



2.10 Hardware Information

You can access the device's software version, ID, battery level, and serial number by scanning the barcodes below. Ensure that your barcode scanner is connected to a device to view the data.

Firmware Version



Device ID



Battery Level



2.11 Vibration Level

You can set the vibration level by scanning the following barcodes, only for the R-Series.

Vibration Off



Level 1



Level 2



Level 3



Level 4



2.12 Factory Setting

You can restore the default factory settings by scanning the following barcode.

Symbologies Default Setting



Bluetooth Default Setting



Chapter 3 – Symbology

3.1 UPC/EAN/JAN

3.1.1 UPC-A

Scan one of the following barcodes to enable or disable UPC-A.

Enable UPC-A*



Disable UPC-A



3.1.2 UPC-E

Scan one of the following barcodes to enable or disable UPC-E.

Enable UPC-E*



Disable UPC-E



3.1.3 UPC-E1

Scan one of the following barcodes to enable or disable UPC-E1.

Note: *UPC-E1 is not a UCC (Uniform Code Council) approved symbology.*

Enable UPC-E1



Disable UPC-E1*



3.1.4 EAN-8/JAN-8

Scan one of the following barcodes to enable or disable EAN-8/JAN-8.

Enable EAN-8/JAN-8*



Disable EAN-8/JAN-8



3.1.5 Transmit EAN-8 Check Digit

The check digit is the last character of the symbol used to verify the integrity of the data. Scan one of the following barcodes to transmit the barcode data with or without the EAN-8 check digit. It is always verified to guarantee the integrity of the data.

Transmit EAN-8 Check Digit *



**Do Not Transmit
EAN-8 Check Digit**



3.1.6 EAN-13/JAN-13

Scan one of the following barcodes to enable or disable EAN-13/JAN-13.

Enable EAN-13/JAN-13*



Disable EAN-13/JAN-13



3.1.7 Transmit EAN-13 Check Digit

The check digit is the last character of the symbol used to verify the integrity of the data. Scan one of the following barcodes to transmit the barcode data with or without the EAN-13 check digit. It is always verified to guarantee the integrity of the data.

Transmit EAN-13 Check Digit *



Do Not Transmit EAN-13 Check Digit



3.1.8 Bookland EAN

If you enable Bookland EAN, select a [Bookland ISBN Format](#). Also set [Decode UPC/EAN/JAN Supplementals](#) to either Decode UPC/EAN/JAN with Supplementals Only, Autodiscriminate UPC/EAN/JAN With Supplementals, or Enable 978/979 Supplemental Mode.

Scan one of the following barcodes to enable or disable Bookland EAN.

Enable Bookland EAN



Disable Bookland EAN*



3.1.9 Bookland ISBN Format

If you enabled Bookland EAN, select one of the following formats for Bookland data:

- **Bookland ISBN-10** - The engine reports Bookland data starting with 978 in traditional 10-digit format with the special Bookland check digit for backward-compatibility. Data starting with 979 is not considered Bookland in this mode.
- **Bookland ISBN-13** - The engine reports Bookland data (starting with either 978 or 979) as EAN-13 in 13-digit format to meet the 2007 ISBN-13 protocol.

Bookland ISBN-10*



Bookland ISBN-13



3.1.10 ISSN EAN

Scan one of the following barcodes to enable or disable ISSN EAN.

Enable ISSN EAN



Disable ISSN EAN *



3.1.11 Decode UPC/EAN/JAN Supplementals

**Decode UPC/EAN/JAN with
Supplementals Only**



Ignore UPC/EAN/JAN Supplementals*



**Autodiscriminate UPC/EAN/JAN with
Supplementals**



Enable 378/379 Supplemental Mode



Enable 978/979 Supplemental Mode



Enable 977 Supplemental Mode



**Enable 414/419/434/439
Supplemental Mode**



Enable Smart Supplemental Mode



**Supplemental User-Programmable
Type 1 and 2**



**Smart Supplemental Plus
User-Programmable 1 and 2**



**Smart Supplemental Plus
User-Programmable 1**



Supplemental User-Programmable Type 1



Enable 491 Supplemental Mode



3.1.12 User-Programmable Supplementals

If you selected a Supplemental User-Programmable option, scan User-Programmable Supplemental 1, and then scan three barcodes from [Appendix B, Numeric Barcodes](#) to set the 3-digit prefix.

To set a second 3-digit prefix, scan User-Programmable Supplemental 2, and then scan three barcodes from [Appendix B, Numeric Barcodes](#). The default is 000 (zeroes).

User-Programmable Supplemental 1



User-Programmable Supplemental 2



3.1.13 UPC/EAN/JAN Supplemental Redundancy

If you selected Autodiscriminate UPC/EAN/JAN with Supplementals, this option sets the number of times to decode a symbol without supplementals before transmission. The range is from 2 to 16. Five or above is recommended when decoding a mix of UPC/EAN/JAN symbols with and without supplementals. The default is 10. To set a redundancy value, scan the following barcode, and then scan two barcodes from [Appendix B, Numeric Barcodes](#). Enter a leading zero for single digit numbers. To correct an error or change a selection, [scan Cancel](#).

UPC/EAN/JAN Supplemental Redundancy



3.1.14 UPC/EAN/JAN Supplemental AIM ID Format

If Transmit Code ID Character is set to AIM Code ID Character, scan one of the following barcodes to select an output format when reporting UPC/EAN/JAN barcodes with supplementals:

- **Separate** - Transmit UPC/EAN/JAN with supplementals with separate AIM IDs but one transmission, i.e.,] E<0 or 4><data>] E<1 or 2> [supplemental data]
- **Combined** – Transmit UPC/EAN/JAN with supplementals with one AIM ID and one transmission, i.e.,] E3<data+supplemental data>
- **Separate Transmissions** - Transmit UPC/EAN/JAN with supplementals with separate AIM IDs and separate transmissions, i.e.,] E<0 or 4><data>] E<1 or 2> [supplemental data]

Separate



Combined*



Separate Transmissions



3.1.15 Transmit UPC-A Check Digit

The check digit is the last character of the symbol used to verify the integrity of the data. Scan one of the following barcodes to transmit the barcode data with or without the UPC-A check digit. It is always verified to guarantee the integrity of the data.

Transmit UPC-A Check Digit*



Do Not Transmit UPC-A Check Digit



3.1.16 Transmit UPC-E Check Digit

The check digit is the last character of the symbol used to verify the integrity of the data. Scan one of the following barcodes to transmit the barcode data with or without the UPC-E check digit. It is always verified to guarantee the integrity of the data.

Transmit UPC-E Check Digit*



Do Not Transmit UPC-E Check Digit

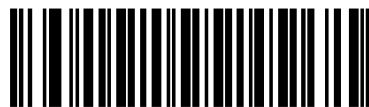

3.1.17 Transmit UPC-E1 Check Digit

The check digit is the last character of the symbol used to verify the integrity of the data. Scan one of the following barcodes to transmit the barcode data with or without the UPC-E1 check digit. It is always verified to guarantee the integrity of the data.

Transmit UPC-E1 Check Digit*

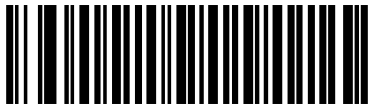

Do Not Transmit UPC-E1 Check Digit



3.1.18 UPC-A Preamble

Preamble characters are part of the UPC symbol, and include Country Code and System Character. Select the appropriate option for transmitting a UPC-A preamble to match the host system:

- Transmit System Character only
- Transmit System Character and Country Code (“0” for USA)
- Transmit no preamble.

No Preamble (<DATA>)



System Character (<SYSTEM CHARACTER> <DATA>*)



**System Character & Country Code
(< COUNTRY CODE>
<SYSTEM CHARACTER> <DATA>)**



3.1.19 UPC-E Preamble

Preamble characters are part of the UPC symbol, and include Country Code and System Character. Select the appropriate option for transmitting a UPC-E preamble to match the host system:

- Transmit System Character only
- Transmit System Character and Country Code (“0” for USA)
- Transmit no preamble.

No Preamble (<DATA>)



System Character (<SYSTEM CHARACTER> <DATA>)*



**System Character & Country Code
(< COUNTRY CODE>
<SYSTEM CHARACTER> <DATA>)**



3.1.20 UPC-E1 Preamble

Preamble characters are part of the UPC symbol, and include Country Code and System Character. Select the appropriate option for transmitting a UPC-E1 preamble to match the host system:

- Transmit System Character only
- Transmit System Character and Country Code (“0” for USA)
- Transmit no preamble.

No Preamble (<DATA>)



System Character (<SYSTEM CHARACTER> <DATA>)*



**System Character & Country Code
(< COUNTRY CODE>
<SYSTEM CHARACTER> <DATA>)**



3.1.21 Convert UPC-E to UPC-A

Enable this to convert UPC-E (zero suppressed) decoded data to UPC-A format before transmission. After conversion, the data follows UPC-A format and is affected by UPC-A programming selections (e.g., Preamble, Check Digit).

Disable this to transmit UPC-E decoded data as UPC-E data, without conversion.

Convert UPC-E to UPC-A (Enable)

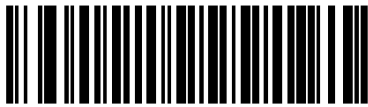

Do Not Convert UPC-E to UPC-A (Disable)*



3.1.22 Convert UPC-E1 to UPC-A

Scan **Convert UPC-E1 to UPC-A (Enable)** to convert UPC-E1 decoded data to UPC-A format before transmission. After conversion, the data follows UPC-A format and is affected by UPC-A programming selections (e.g., Preamble, Check Digit).

Scan **Do Not Convert UPC-E1 to UPC-A (Disable)** to transmit UPC-E1 decoded data as UPC-E1 data, without conversion.

Convert UPC-E1 to UPC-A (Enable)

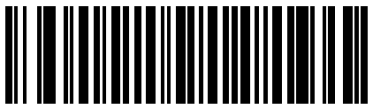

**Do Not Convert UPC-E1 to UPC-A
(Disable)***



3.1.23 EAN/JAN Zero Extend

Scan **Enable EAN/JAN Zero Extend** to add five leading zeros to decoded EAN-8 symbols to make them compatible in length to EAN-13 symbols.

Scan **Disable EAN/JAN Zero Extend** to transmit EAN-8 symbols as is.

Enable EAN/JAN Zero Extend



Disable EAN/JAN Zero Extend*



3.1.24 UCC Coupon Extended Code

Scan **Enable UCC Coupon Extended Code** to decode UPC-A barcodes starting with digit '5', EAN-13 barcodes starting with digit '99', and UPC-A/GS1-128 coupon codes. UPC-A, EAN-13, and GS1-128 must be enabled to use this feature.

Enable UCC Coupon Extended Code

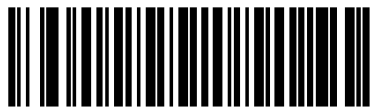

Disable UCC Coupon Extended Code*



3.1.25 Coupon Report

Scan one of the following barcodes to select the type of coupon format to support.

- **Old Coupon Format** - Support UPC-A/GS1-128 and EAN-13/GS1-128.
- **New Coupon Format** - An interim format to support UPC-A/GS1-DataBar and EAN-13/GS1-DataBar.
- **Autodiscriminate Format** - Support both Old Coupon Format and New Coupon Format.

Old Coupon Format



New Coupon Format*



Auto discriminate Coupon Format



3.1.26 UPC Reduced Quiet Zone

Scan one of the following barcodes to enable or disable decoding UPC barcodes with reduced quiet zones (the margins on either side of the barcode). If you select **Enable**, select a [1D Quiet Zone Level](#).

Enable UPC Reduced Quiet Zone



Disable UPC Reduced Quiet Zone*



3.1.27 Code 128

Scan one of the following barcodes to enable or disable Code 128.

Note: *Disable Code 128 might cause setting barcode cannot be recognized resulted in setting unperformable.*

Enable Code 128*



Disable Code 128



3.1.28 Set Lengths for Code 128

The length of a code refers to the number of characters (i.e., human readable characters), including check digit(s) the code contains. Set lengths for Code 128 to any length, one or two discrete lengths, or lengths within a specific range. The default is **Any Length**.

Note: *When setting lengths, enter a leading zero for single digit numbers.*

Scan one of the following barcodes to select a length option:

- **One Discrete Length** - Decode only Code 128 symbols containing a selected length. Select the length using the barcodes in [Appendix B, Numeric Barcodes](#). For example, to decode only Code 128 symbols with 14 characters, scan Code 128 - One Discrete Length, and then scan 1, 4. To correct an error or change the selection, [scan Cancel](#).
- **Two Discrete Lengths** - Decode only Code 128 symbols containing either of two lengths. Select lengths using the barcodes in [Appendix B, Numeric Barcodes](#). For example, to decode only Code 128 symbols containing either 2 or 14 characters, scan Code 128 - Two Discrete Lengths, and then scan 0, 2, 1, 4. To correct an error or change the selection, [scan Cancel](#).
- **Length Within Range** - Decode Code 128 symbols with a specific length range. Select lengths using the barcodes in [Appendix B, Numeric Barcodes](#). For example, to decode Code 128 symbols containing between 4 and 12 characters, scan Code 128 - Length Within Range, and then scan 0, 4, 1, 2. To correct an error or change the selection, [scan Cancel](#).
- **Any Length** - Decode Code 128 symbols containing any number of characters within the engine's capability.

3.1.29 Set Lengths for Code 128

Code 128 - One Discrete Length



Code 128 - Two Discrete Lengths



Code 128 - Length Within Range

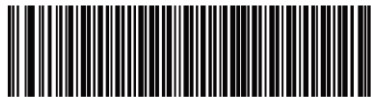

Code 128 - Any Length*



3.1.30 GS1-128 (formerly UCC/EAN-128)

Scan one of the following barcodes to enable or disable GS1-128.

Enable GS1-128*

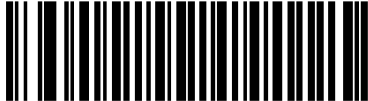

Disable GS1-128

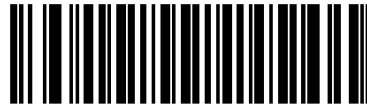

3.1.31 ISBT 128

ISBT 128 is a variant of Code 128 used in the blood bank industry. Scan one of the following barcodes to enable or disable ISBT 128.

Enable ISBT 128*



Disable ISBT 128



3.1.32 ISBT Concatenation

Select an option for concatenating pairs of ISBT code types:

- **Enable ISBT Concatenation** –

There must be two ISBT codes in order for the engine to decode and perform concatenation. The engine does not decode single ISBT symbols.

- **Disable ISBT Concatenation** –

The engine does not concatenate pairs of ISBT codes it encounters.

- **Autodiscriminate ISBT Concatenation** –

The engine decodes and concatenates pairs of ISBT codes immediately. If only a single ISBT symbol is present, the engine must decode the symbol the number of times set via ISBT Concatenation Redundancy before transmitting its data to confirm that there is no additional ISBT symbol.

Enable ISBT Concatenation



Disable ISBT Concatenation*



Autodiscriminate ISBT Concatenation



3.1.33 Check ISBT Table

The ISBT specification includes a table that lists several types of ISBT barcodes that are commonly used in pairs. If you set **ISBT Concatenation to Enable**, enable **Check ISBT Table** to concatenate only those pairs found in this table. Other types of ISBT codes are not concatenated.

Enable Check ISBT Table*



Disable Check ISBT Table



3.1.34 ISBT Concatenation Redundancy

If you set ISBT Concatenation to Autodiscriminate (the default), use this parameter to set the number of times the engine must decode an ISBT symbol before determining that there is no additional symbol.

Scan the following barcode, and then scan barcodes in [Appendix B, Numeric Barcodes](#) to set a value between 2 and 20. Enter a leading zero for single digit numbers. To correct an error or change a selection, [scan Cancel](#). The default is 10.

ISBT Concatenation Redundancy



3.1.35 Code 128 <FNC4>

This feature applies to Code 128 barcodes with an embedded <FNC4> character. Select **Ignore Code 128 <FNC4>** to strip the <FNC4> character from the decode data. The remaining characters are sent to the host unchanged. When disabled, the <FNC4> character is processed normally as per Code 128 standard.

Honor Code 128 <FNC4>*



Ignore Code 128 <FNC4>



3.1.36 Code 128 Security Level

Code 128 barcodes are vulnerable to misdecodes, particularly when Code 128 Lengths is set to **Any Length**. The engine offers four levels of decode security for Code 128 barcodes. There is an inverse relationship between security and engine aggressiveness. Increasing the level of security can reduce scanning aggressiveness, so select only the level of security necessary.

- **Code 128 Security Level 0** - The engine operates in its most aggressive state, while providing sufficient security in decoding most in-spec barcodes.
- **Code 128 Security Level 1** - This option eliminates most misdecodes while maintaining reasonable aggressiveness.
- **Code 128 Security Level 2** - This option applies greater barcode security requirements if Security Level 1 fails to eliminate misdecodes.
- **Code 128 Security Level 3** - If you selected Security Level 2, and misdecodes still occur, select this security level to apply the highest safety requirements.

NOTE:

Selecting this option is an extreme measure against mis-decoding severely out-of-spec barcodes, and significantly impairs the decoding ability of the engine. If this level of security is required, try to improve the quality of the barcodes.

3.1.37 Code 128 Security Level (continued)

Code 128 Security Level 0



Code 128 Security Level 1*



Code 128 Security Level 2



Code 128 Security Level 3



3.1.38 Code 128 Reduced Quiet Zone

Scan one of the following barcodes to enable or disable decoding Code 128 barcodes with reduced quiet zones (the margins on either side of the barcode). If you select Enable, select a [1D Quiet Zone Level](#).

Enable Code 128 Reduced Quiet Zone



Disable Code 128 Reduced Quiet Zone*



3.1.39 GS1-128 Emulation Mode for UCC/EAN Composite Codes

Enable GS1-128 Emulation Mode for
UCC/EAN Composite Codes



Disable GS1-128 Emulation Mode for
UCC/EAN Composite Codes *



3.1.40 Composite Beep Mode

Scan one of the following barcodes to select the number of decode beeps that sound upon decoding a Composite barcode.

Single Beep After Both Are Decoded



Beep as Each Code Type Is Decoded *



Double Beep After Both Are Decoded



3.2 Code 39

3.2.1 Code 128 Reduced Quiet Zone

Scan one of the following barcodes to enable or disable Code 39.

Enable Code 39*



Disable Code 39



3.2.2 Trioptic Code 39

Trioptic Code 39 is a variant of Code 39 used in the marking of computer tape cartridges. Trioptic Code 39 symbols always contain six characters. Scan one of the following barcodes to enable or disable Trioptic Code 39.

NOTE: *You cannot enable Trioptic Code 39 and Code 39 Full ASCII simultaneously.*

Enable Trioptic Code 39



Disable Trioptic Code 39*



3.2.3 Convert Code 39 to Code 32

Code 32 is a variant of Code 39 used by the Italian pharmaceutical industry. Scan one of the following barcodes to enable or disable converting Code 39 to Code 32.

NOTE: Code 39 must be enabled for this parameter to function.

Enable Convert Code 39 to Code 32



Disable Convert Code 39 to Code 32*



3.2.4 Code 32 Prefix

Scan one of the following barcodes to enable or disable adding the prefix character “A” to all Code 32 barcodes.

NOTE: Convert Code 39 to Code 32 must be enabled for this parameter to function.

Enable Code 32 Prefix



Disable Code 32 Prefix*



3.2.5 Set Lengths for Code 39

The length of a code refers to the number of characters (i.e., human readable characters), including check digit(s) the code contains. Set lengths for Code 39 to any length, one or two discrete lengths, or lengths within a specific range. If Code 39 Full ASCII is enabled, Length Within Range or Any Length are the preferred options. The default is Length Within Range: 1 to 55.

Scan one of the following barcodes to select a length option:

- **One Discrete Length** - Decode only Code 39 symbols containing a selected length. Select the length using the barcodes in [Appendix B, Numeric Barcodes](#). For example, to decode only Code 39 symbols with 14 characters, scan Code 39 - One Discrete Length, and then scan 1, 4. To correct an error or change the selection, [scan Cancel](#).
- **Two Discrete Lengths** - Decode only Code 39 symbols containing either of two lengths. Select lengths using the barcodes in [Appendix B, Numeric Barcodes](#). For example, to decode only Code 39 symbols containing either 2 or 14 characters, scan Code 39 - Two Discrete Lengths, and then scan 0, 2, 1, 4. To correct an error or change the selection, [scan Cancel](#).
- **Length Within Range** - Decode Code 39 symbols with a specific length range. Select lengths using the barcodes in [Appendix B, Numeric Barcodes](#). For example, to decode Code 39 symbols containing between 4 and 12 characters, scan Code 39 - Length Within Range, and then scan 0, 4, 1, 2. To correct an error or change the selection, [scan Cancel](#).
- **Any Length** - Decode Code 39 symbols containing any number of characters within the engine's capability.

Note: When setting lengths, enter a leading zero for single digit numbers.

3.2.6 Set Lengths for Code 39

Code 39 - One Discrete Length



Code 39 - Two Discrete Lengths



Code 39 - Length Within Range

(Default: 1 to 55)*



Code 39 - Any Length



3.2.7 Code 39 Check Digit Verification

Scan Enable Code 39 Check Digit to check the integrity of all Code 39 symbols to verify that the data complies with specified check digit algorithm. Only Code 39 symbols which include a modulo 43 check digit are decoded. Enable this feature if the Code 39 symbols contain a Modulo 43 check digit.

Enable Code 39 Check Digit



Disable Code 39 Check Digit *



3.2.8 Transmit Code 39 Check Digit

Scan one of the following barcodes to transmit Code 39 data with or without the check digit.

NOTE: Code 39 Check Digit Verification must be enabled for this parameter to function.

Transmit Code 39 Check Digit (Enable)



Do Not Transmit Code 39 Check Digit (Disable) *

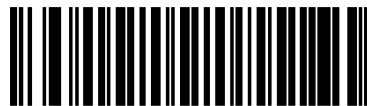

3.2.9 Code 39 Full ASCII Conversion

Code 39 Full ASCII is a variant of Code 39 which pairs characters to encode the full ASCII character set. Scan one of the following barcodes to enable or disable Code 39 Full ASCII.

NOTE: You cannot enable Trioptic Code 39 and Code 39 Full ASCII simultaneously.

Enable Code 39 Full ASCII



Disable Code 39 Full ASCII *



3.2.10 Code 39 Security Level

The engine offers four levels of decode security for Code 39 barcodes. There is an inverse relationship between security and engine aggressiveness. Increasing the level of security can reduce scanning aggressiveness, so select only the level of security necessary.

- **Code 39 Security Level 0:** The engine operates in its most aggressive state, while providing sufficient security in decoding most in-spec barcodes.
- **Code 39 Security Level 1:** This default setting eliminates most misdecodes.
- **Code 39 Security Level 2:** This option applies greater barcode security requirements if Security Level 1 fails to eliminate misdecodes.
- **Code 39 Level 3:** If you selected Security Level 2, and misdecodes still occur, select this security level to apply the highest safety requirements.

NOTE:

Selecting this option is an extreme measure against mis-decoding severely out-of-spec barcodes, and significantly impairs the decoding ability of the engine. If this level of security is required, try to improve the quality of the barcodes.

3.2.11 Code 39 Security Level

Code 39 Security Level 0



Code 39 Security Level 1*



Code 39 Security Level 2



Code 39 Security Level 3



3.2.12 Code 39 Reduced Quiet Zone

Scan one of the following barcodes to enable or disable decoding Code 39 barcodes with reduced quiet zones (the margins on either side of the barcode). If you select Enable, select a [1D Quiet Zone Level](#).

Enable Code 39 Reduced Quiet Zone



Disable Code 39 Reduced Quiet Zone*



3.3 Code 93

Scan one of the following barcodes to enable or disable Code 93.

Enable Code 93*



Disable Code 93



3.3.1 Set Lengths for Code 93

The length of a code refers to the number of characters (i.e., human readable characters), including check digit(s) the code contains. Set lengths for Code 93 to any length, one or two discrete lengths, or lengths within a specific range. The default is **Length Within Range: 1 to 55**.

Note: When setting lengths, enter a leading zero for single digit numbers.

Scan one of the following barcodes to select a length option:

- **One Discrete Length** - Decode only Code 93 symbols containing a selected length. Select the length using the barcodes in [Appendix B, Numeric Barcodes](#). For example, to decode only Code 93 symbols with 14 characters, scan **Code 93 - One Discrete Length**, and then scan **1, 4**. To correct an error or change the selection, [scan Cancel](#).
- **Two Discrete Lengths** - Decode only Code 93 symbols containing either of two lengths. Select lengths using the barcodes in

[Appendix B, Numeric Barcodes](#). For example, to decode only Code 93 symbols containing either 2 or 14 characters, scan **Code 93 - Two Discrete Lengths**, and then scan **0, 2, 1, 4**. To correct an error or change the selection, [scan Cancel](#).

- **Length Within Range -** Decode Code 93 symbols with a specific length range. Select lengths using the barcodes in [Appendix B, Numeric Barcodes](#). For example, to decode Code 93 symbols containing between 4 and 12 characters, scan **Code 93 - Length Within Range**, and then scan **0, 4, 1, 2**. To correct an error or change the selection, [scan Cancel](#).
- **Any Length -** Decode Code 93 symbols containing any number of characters within the engine’s capability.

Set Lengths for Code 93 (continued)

Code 93 - One Discrete Length



Code 93 - Two Discrete Lengths



Code 93 - Length Within Range*



Code 93 - Any Length



3.4 Code 11

Scan one of the following barcodes to enable or disable Code 11.

Code 93 - Length Within Range *



Code 93 - Any Length



Enable Code 11



Disable Code 11*



3.4.1 Set Lengths for Code 11

The length of a code refers to the number of characters (i.e., human readable characters), including check digit(s) the code contains. Set lengths for Code 11 to any length, one or two discrete lengths, or lengths within a specific range. The default is Length Within Range: 4 to 55.

Note: *When setting lengths, enter a leading zero for single digit numbers.*

Scan one of the following barcodes to select a length option:

- **One Discrete Length** - Decode only Code 11 symbols containing a selected length. Select the length using the barcodes in [Appendix B, Numeric Barcodes](#). For example, to decode only Code 11 symbols with 14 characters, scan Code 11 - One Discrete Length, and then scan 1, 4. To correct an error or change the selection, [scan Cancel](#).
- **Two Discrete Lengths** - Decode only Code 11 symbols containing either of two lengths. Select lengths using the barcodes in [Appendix B, Numeric Barcodes](#). For example, to decode only Code 11 symbols containing either 2 or 14 characters, scan Code 11 - Two Discrete Lengths, and then scan 0, 2, 1, 4. To correct an error or change the selection, [scan Cancel](#).
- **Length Within Range** - Decode Code 11 symbols with a specific length range. Select lengths using the barcodes in [Appendix B, Numeric Barcodes](#). For example, to decode Code 11 symbols containing between 4 and 12 characters, scan Code 11 - Length Within Range, and then scan 0, 4, 1, 2. To correct an error or change the selection, [scan Cancel](#).
- **Any Length** - Decode Code 11 symbols containing any number of characters within the engine's capability.

Code 11 - One Discrete Length**Code 11 - Two Discrete Lengths****Code 11 - Length Within Range***
(Default: 4 to 55)**Code 11 - Any Length**

3.4.2 Code 11 Check Digit Verification

This feature allows the engine to check the integrity of all Code 11 symbols to verify that the data complies with the specified check digit algorithm. Scan one of the following barcodes to specify the number of check digits encoded in the Code 11 symbols, or to disable this feature.

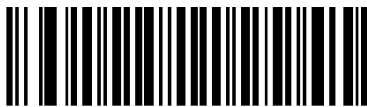
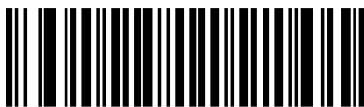
Disable***One Check Digit****Two Check Digits**

3.4.3 Transmit Code 11 Check Digits

Scan one of the following barcodes to select whether or not to transmit the Code 11 check digit(s).

Do Not Transmit Code 11 Check Digit(s)
(Disable)*



Transmit Code 11 Check Digit(s) (Enable)

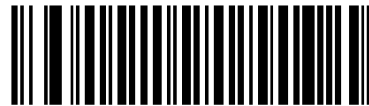

3.5 Interleaved 2 of 5 (ITF)

Scan one of the following barcodes to enable or disable Interleaved 2 of 5.

Enable Interleaved 2 of 5



Disable Interleaved 2 of 5*



3.5.1 Set Lengths for Interleaved 2 of 5

The length of a code refers to the number of characters (i.e., human readable characters), including check digit(s) the code contains. Set lengths for I 2 of 5 to any length, one or two discrete lengths, or lengths within a specific range.

The range for Interleaved 2 of 5 lengths is 0 - 80. The default is Length Within Range: 6 to 55.

Note: *When setting lengths, enter a leading zero for single digit numbers.*

Scan one of the following barcodes to select a length option:

- **One Discrete Length** - Decode only I 2 of 5 symbols containing a selected length. Select the length using the barcodes in [Appendix B, Numeric Barcodes](#). For example, to decode only I 2 of 5 symbols with 14 characters, scan I 2 of 5 - One Discrete Length, and then scan 1, 4. To correct an error or change the selection, [scan Cancel](#).
- **Two Discrete Lengths** - Decode only I 2 of 5 symbols containing either of two lengths. Select lengths using the barcodes in [Appendix B, Numeric Barcodes](#). For example, to decode only I 2 of 5 symbols containing either 2 or 14 characters, scan I 2 of 5 - Two Discrete Lengths, and then scan 0, 2, 1, 4. To correct an error or change the selection, [scan Cancel](#).
- **Length Within Range** - Decode I 2 of 5 symbols with a specific length range. Select lengths using the barcodes in [Appendix B, Numeric Barcodes](#). For example, to decode I 2 of 5 symbols containing between 4 and 12 characters, scan I 2 of 5 - Length Within Range, and then scan 0, 4, 1, 2. To correct an error or change the selection, [scan Cancel](#).
- **Any Length** - Decode I 2 of 5 symbols containing any number of characters within the engine's capability

Note:

Due to the construction of the I 2 of 5 symbology, it is possible for a scan line covering only a portion of the code to transmit as a complete scan, yielding less data than is encoded in the barcode. To prevent this, select specific lengths (I 2 of 5 - One Discrete Length, Two Discrete Lengths) for I 2 of 5 applications, or increase the [I 2 of 5 Security Level](#).

I 2 of 5 - One Discrete Length



I 2 of 5 - Length Within Range *
(Default: 6 to 55)



I 2 of 5 - Two Discrete Lengths



I 2 of 5 - Any Length



3.5.2 Set Lengths for Interleaved 2 of 5

The length of a code refers to the number of characters (i.e., human readable characters), including check digit(s) the code contains. Set lengths for I 2 of 5 to any length, one or two discrete lengths, or lengths within a specific range. The range for Interleaved 2 of 5 lengths is 0 - 80. The default is Length Within Range: 6 to 55.

Note: When setting lengths, enter a leading zero for single digit numbers.

Scan one of the following barcodes to select a length option:

- **One Discrete Length** - Decode only I 2 of 5 symbols containing a selected length. Select the length using the barcodes in [Appendix B, Numeric Barcodes](#). For example, to decode only I 2 of 5 symbols with 14 characters, scan I 2 of 5 - One Discrete Length, and then scan 1, 4. To correct an error or change the selection, [scan Cancel](#).
- **Two Discrete Lengths** - Decode only I 2 of 5 symbols containing either of two lengths. Select lengths using the barcodes in [Appendix B, Numeric Barcodes](#). For example, to decode only I 2 of 5 symbols containing either 2 or 14 characters, scan I 2 of 5 - Two Discrete Lengths, and then scan 0, 2, 1, 4. To correct an error or change the selection, [scan Cancel](#).
- **Length Within Range** - Decode I 2 of 5 symbols with a specific length range. Select lengths using the barcodes in [Appendix B, Numeric Barcodes](#). For example, to decode I 2 of 5 symbols containing between 4 and 12 characters, scan I 2 of 5 - Length Within Range, and then scan 0, 4, 1, 2. To correct an error or change the selection, [scan Cancel](#).
- **Any Length** - Decode I 2 of 5 symbols containing any number of characters within the engine's capability

Note:

Due to the construction of the I 2 of 5 symbology, it is possible for a scan line covering only a portion of the code to transmit as a complete scan, yielding less data than is encoded in the barcode. To prevent this, select specific lengths (I 2 of 5 - One Discrete Length, Two Discrete Lengths) for I 2 of 5 applications, or increase the [I 2 of 5 Security Level](#).

I 2 of 5 - One Discrete Length**I 2 of 5 - Length Within Range ***
(Default: 6 to 55)**I 2 of 5 - Two Discrete Lengths****I 2 of 5 - Any Length**

3.5.3 I 2 of 5 Check Digit Verification

Scan one of the following barcodes to check the integrity of all I 2 of 5 symbols to verify the data complies with either the specified Uniform Symbology Specification (USS), or the Optical Product Code Council (OPCC) check digit algorithm.

Disable*



USS Check Digit



OPCC Check Digit



3.5.4 Transmit I 2 of 5 Check Digit

Scan one of the following barcodes to transmit I 2 of 5 data with or without the check digit.

Transmit I 2 of 5 Check Digit (Enable)



Do Not Transmit I 2 of 5 Check Digit

(Disable)*



3.5.5 Convert I 2 of 5 to EAN-13

Scan Convert I 2 of 5 to EAN-13 (Enable) to convert 14-character I 2 of 5 codes to EAN-13, and transmit to the host as EAN-13. To accomplish this, the I 2 of 5 code must be enabled, and the code must have a leading zero and a valid EAN-13 check digit.

Convert I 2 of 5 to EAN-13 (Enable)



Do Not Convert I 2 of 5 to EAN-13 (Disable)*



3.5.6 Febraban

Febraban is an I 2 of 5 barcode of length 44 that requires special check characters to be inserted in the transmitted data stream. When enabled, the I 2 of 5 internal check digit calculation and transmission is disabled. When disabled, all I 2 of 5 functionality works as usual.

Recommendations for Length Setting

I 2 of 5 Length 1: Larger of the fixed length and the FEBRABAN length (==44).

I 2 of 5 Length 2: Smaller of the fixed length and the FEBRABAN length (==44).

Convert I 2 of 5 to EAN-13 (Enable)



Do Not Convert I 2 of 5 to EAN-13 (Disable)*



Enable Febraban



Disable Febraban *



3.5.7 I 2 of 5 Security Level

Interleaved 2 of 5 barcodes are vulnerable to misdecodes, particularly when I 2 of 5 Lengths is set to Any Length. The engine offers four levels of decode security for Interleaved 2 of 5 barcodes. There is an inverse relationship between security and engine aggressiveness. Increasing the level of security can reduce scanning aggressiveness, so select only the level of security necessary.

- **I 2 of 5 Security Level 0:** The engine operates in its most aggressive state, while providing sufficient security in decoding most in-spec barcodes.
- **I 2 of 5 Security Level 1:** A barcode must be successfully read twice, and satisfy certain safety requirements before being decoded. This default setting eliminates most misdecodes.
- **I 2 of 5 Security Level 2:** This option applies greater barcode security requirements if Security Level 1 fails to eliminate misdecodes.
- **I 2 of 5 Security Level 3:** If you selected Security Level 2, and misdecodes still occur, select this security level. The highest safety requirements are applied. A barcode must be successfully read three times before being decoded.

Note:

Selecting this option is an extreme measure against mis-decoding severely out-of-spec barcodes, and significantly impairs the decoding ability of the engine. If this level of security is required, try to improve the quality of the barcodes.

I 2 of 5 Security Level 0**I 2 of 5 Security Level 1*****I 2 of 5 Security Level 2****I 2 of 5 Security Level 3**

3.5.8 I 2 of 5 Reduced Quiet Zone

Scan one of the following barcodes to enable or disable decoding I 2 of 5 barcodes with reduced quiet zones (the margins on either side of the barcode). If you select Enable, select a [1D Quiet Zone Level](#).

Enable I 2 of 5 Reduced Quiet Zone**Disable I 2 of 5 Reduced Quiet Zone***

3.6 Discrete 2 of 5 (DTF)

Scan one of the following barcodes to enable or disable Discrete 2 of 5.

Enable Discrete 2 of 5



Disable Discrete 2 of 5*



3.6.1 Set Lengths for Discrete 2 of 5

The length of a code refers to the number of characters (i.e., human readable characters), including check digit(s) the code contains. Set lengths for D 2 of 5 to any length, one or two discrete lengths, or lengths within a specific range. The default is **Length Within Range**: 1 to 55.

Note: When setting lengths, enter a leading zero for single digit numbers.

Scan one of the following barcodes to select a length option:

- **One Discrete Length** - Decode only D 2 of 5 symbols containing a selected length. Select the length using the barcodes in [Appendix B, Numeric Barcodes](#). For example, to decode only D 2 of 5 symbols with 14 characters, scan D 2 of 5 - One Discrete Length, and then scan 1, 4. To correct an error or change the selection, [scan Cancel](#).
- **Two Discrete Lengths** - Decode only D 2 of 5 symbols containing either of two lengths. Select lengths using the barcodes in [Appendix B, Numeric Barcodes](#). For example, to decode only D 2 of 5 symbols containing either 2

or 14 characters, scan D 2 of 5 - Two Discrete Lengths, and then scan 0, 2, 1, 4. To correct an error or change the selection, [scan Cancel](#).

- **Length Within Range -** Decode D 2 of 5 symbols with a specific length range. Select lengths using the barcodes in [Appendix B, Numeric Barcodes](#). For example, to decode D 2 of 5 symbols containing between 4 and 12 characters, scan D 2 of 5 - Length Within Range, and then scan 0, 4, 1, 2. To correct an error or change the selection, [scan Cancel](#).
- **Any Length -** Decode D 2 of 5 symbols containing any number of characters within the engine’s capability.

Note:

Due to the construction of the D 2 of 5 symbology, it is possible for a scan line covering only a portion of the code to transmit as a complete scan, yielding less data than is encoded in the barcode. To prevent this, select specific lengths (D 2 of 5 - One Discrete Length, Two Discrete Lengths) for D 2 of 5 applications.

D 2 of 5 - One Discrete Length



D 2 of 5 - Two Discrete Lengths



D 2 of 5 - Length Within Range *

(Default: 1 to 55)



D 2 of 5 - Any Length



3.7 Codabar (NW - 7)

Scan one of the following barcodes to enable or disable Codabar.

Enable Codabar*



Disable Codabar



3.7.1 Set Lengths for Codabar

The length of a code refers to the number of characters (i.e., human readable characters), including check digit(s) the code contains. Set lengths for Codabar to any length, one or two discrete lengths, or lengths within a specific range. The default is Length Within Range: 4 to 55.

Note: When setting lengths, enter a leading zero for single digit numbers.

Scan one of the following barcodes to select a length option:

- **One Discrete Length** - Decode only Codabar symbols containing a selected length. Select the length using the barcodes in [Appendix B, Numeric Barcodes](#). For example, to decode only Codabar symbols with 14 characters, scan Codabar - One Discrete Length, and then scan 1, 4. To correct an error or change the selection, [scan Cancel](#).
- **Two Discrete Lengths** - Decode only Codabar symbols containing either of two lengths. Select lengths using the barcodes in [Appendix B, Numeric Barcodes](#). For example, to

decode only Codabar symbols containing either 2 or 14 characters, scan Codabar - Two Discrete Lengths, and then scan 0, 2, 1, 4. To correct an error or change the selection, [scan Cancel](#).

- **Length Within Range -** Decode Codabar symbols with a specific length range. Select lengths using the barcodes in [Appendix B, Numeric Barcodes](#). For example, to decode Codabar symbols containing between 4 and 12 characters, scan Codabar - Length Within Range, and then scan 0, 4, 1, 2. To correct an error or change the selection, [scan Cancel](#).
- **Any Length -** Decode Codabar symbols containing any number of characters within the engine's capability.

Codabar - One Discrete Length



Codabar - Two Discrete Lengths



Codabar - Length Within Range*

(Default: 4 to 55)



Codabar - Any Length



3.7.2 CLSI Editing

Scan **Enable CLSI Editing** to strip the start and stop characters and insert a space after the first, fifth, and tenth characters of a 14-character Codabar symbol if the host system requires this data format.

NOTE: *Symbol length does not include start and stop characters.*

Enable CLSI Editing



Disable CLSI Editing*

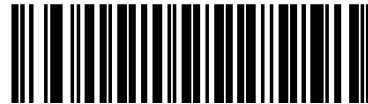

3.7.3 NOTIS Editing

Scan **Enable NOTIS Editing** to strip the start and stop characters from a decoded Codabar symbol if the host system requires this data format.

Enable NOTIS Editing



Disable NOTIS Editing*



3.7.4 Codabar Security Level

The engine offers four levels of decode security for Codabar barcodes. There is an inverse relationship between security and engine aggressiveness. Increasing the level of security can reduce scanning aggressiveness, so select only the level of security necessary.

- **Codabar Security Level 0:** This setting allows the engine to operate in its most aggressive state, while providing sufficient security in decoding most in-spec barcodes.
- **Codabar Security Level 1:** This default setting eliminates most misdecodes.
- **Codabar Security Level 2:** Select this option with greater barcode security requirements if **Security Level 1** fails to eliminate misdecodes.
- **Codabar Security Level 3:** If you selected **Security Level 2**, and misdecodes still occur, select this security level to apply the highest safety requirements.

NOTE:

Selecting this option is an extreme measure against mis-decoding severely out-of-spec barcodes, and significantly impairs the decoding ability of the engine. If this level of security is required, try to improve the quality of the barcodes.

Codabar Security Level 0



Codabar Security Level 1*



Codabar Security Level 2



Codabar Security Level 3



3.7.5 Codabar Upper or Lower Case Start/Stop Characters

Scan one of the following barcodes to select whether to transmit upper case or lower case Codabar start/stop characters.

Lower Case



Upper Case*

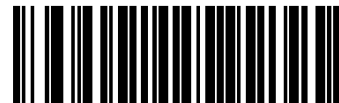

3.7.6 Codabar Mod 16 Check Digit Verification

Enable this feature to check the Codabar Mod 16 Check Digit to verify that the data complies with the specified check digit algorithm.

Enable Codabar Mod 16 Check Digit



Disable Codabar Mod 16 Check Digit *



3.7.7 Transmit Codabar Check Digit

Scan one of the following barcodes to select whether or not to transmit the Codabar check digit(s).

NOTE:

[Codabar Mod 16 Check Digit Verification](#) must be enabled for this parameter to function.

Enable Codabar Check Digit Transmission



Disable Codabar Check Digit Transmission *



3.8 MSI

Scan one of the following barcodes to enable or disable MSI.

Enable MSI



Disable MSI *



3.8.1 Set Lengths for MSI

The length of a code refers to the number of characters (i.e., human readable characters), including check digit(s) the code contains. Set lengths for MSI to any length, one or two discrete lengths, or lengths within a specific range. The default is Length Within Range: 4 to 55.

Note: When setting lengths, enter a leading zero for single digit numbers.

Scan one of the following barcodes to select a length option:

- **One Discrete Length** - Decode only MSI symbols containing a selected length. Select the length using the barcodes in [Appendix B, Numeric Barcodes](#). For example, to decode only MSI symbols with 14 characters, scan MSI - One Discrete Length, and then scan 1, 4. To correct an error or change the selection, [scan Cancel](#).
- **Two Discrete Lengths** - Decode only MSI symbols containing either of two lengths. Select lengths using the barcodes in [Appendix B, Numeric Barcodes](#). For example, to decode only MSI symbols containing either 2 or 14 characters, scan MSI - Two Discrete Lengths,

- and then scan 0, 2, 1, 4. To correct an error or change the selection, [scan Cancel](#).
- **Length Within Range -** Decode MSI symbols with a specific length range. Select lengths using the barcodes in [Appendix B, Numeric Barcodes](#). For example, to decode MSI symbols containing between 4 and 12 characters, scan MSI - Length Within Range, and then scan 0, 4, 1, 2. To correct an error or change the selection, [scan Cancel](#).
 - **Any Length -** Decode MSI symbols containing any number of characters within the engine's capability.

Note:

Due to the construction of the MSI symbology, it is possible for a scan line covering only a portion of the code to transmit as a complete scan, yielding less data than is encoded in the barcode. To prevent this, select specific lengths (MSI - One Discrete Length, Two Discrete Lengths) for MSI applications.

MSI - One Discrete Length**MSI - Two Discrete Lengths****MSI - Length Within Range***

(Default: 4 to 55)

**MSI - Any Length**

3.8.2 MSI Check Digits

With MSI symbols, one check digit is mandatory and always verified by the reader. The second check digit is optional. If the MSI codes include two check digits, scan the Two MSI Check Digits barcode to enable verification of the second check digit.

- 0 - Does not check the MSI check digit; decodes MSI with no check digit.
- 1 - This is for MSI barcodes with one check digit. This is the default.
- 2 - This is for MSI barcodes with two check digits.

See [MSI Check Digit Algorithm](#) to select second digit algorithms.

No MSI Check Digit



One MSI Check Digit *



Two MSI Check Digits

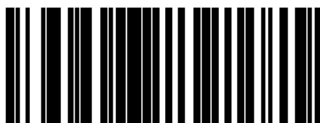

3.8.3 Transmit MSI Check Digit(s)

Scan one of the following barcodes to transmit MSI data with or without the check digit.

Transmit MSI Check Digit(s) (Enable)



**Do Not Transmit MSI Check Digit(s)
(Disable)***

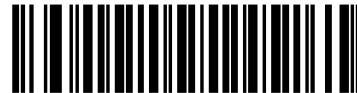

3.8.4 MSI Check Digit Algorithm

Two algorithms are available for verifying the second MSI check digit. Scan one of the following barcodes to select the algorithm used to encode the check digit.

MOD 11/MOD 10



MOD 10/MOD 10 *

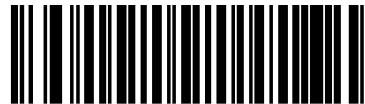

3.8.5 MSI Reduced Quiet Zone

Scan one of the following barcodes to enable or disable decoding MSI barcodes with reduced quiet zones. If you select Enable, select a [1D Quiet Zone Level](#).

Disable MSI Reduced Quiet Zone*



Enable MSI Reduced Quiet Zone



3.9 Chinese 2 of 5

Scan one of the following barcodes to enable or disable Chinese 2 of 5.

Enable Chinese 2 of 5



Disable Chinese 2 of 5*



3.10 Matrix 2 of 5

Scan one of the following barcodes to enable or disable Matrix 2 of 5.

Enable Matrix 2 of 5



Disable Matrix 2 of 5*



3.10.1 Set Lengths for Matrix 2 of 5

The length of a code refers to the number of characters (i.e., human readable characters), including check digit(s) the code contains. Set lengths for Matrix 2 of 5 to any length, one or two discrete lengths, or lengths within a specific range. The default is Length Within Range: 4 to 55.

Note: When setting lengths, enter a leading zero for single digit numbers.

Scan one of the following barcodes to select a length option:

- **One Discrete Length** - Decode only Matrix 2 of 5 symbols containing a selected length. Select the length using the barcodes in [Appendix B, Numeric Barcodes](#). For example, to decode only Matrix 2 of 5 symbols with 14 characters, scan Matrix 2 of 5 - One Discrete Length, and then scan 1, 4. To correct an error or change the selection, [scan Cancel](#).
- **Two Discrete Lengths** - Decode only Matrix 2 of 5 symbols containing either of two lengths. Select lengths using the barcodes in [Appendix B, Numeric Barcodes](#). For

example, to decode only Matrix 2 of 5 symbols containing either 2 or 14 characters, scan Matrix 2 of 5 - Two Discrete Lengths, and then scan 0, 2, 1, 4. To correct an error or change the selection, [scan Cancel](#).

- **Length Within Range -** Decode Matrix 2 of 5 symbols with a specific length range. Select lengths using the barcodes in [Appendix B, Numeric Barcodes](#). For example, to decode Matrix 2 of 5 symbols containing between 4 and 12 characters, scan Matrix 2 of 5 - Length Within Range, and then scan 0, 4, 1, 2. To correct an error or change the selection, [scan Cancel](#).
- **Any Length -** Decode Matrix 2 of 5 symbols containing any number of characters within the engine’s capability.

Matrix 2 of 5 - One Discrete Length



Matrix 2 of 5 - Two Discrete Lengths



Matrix 2 of 5 - Length Within Range *
(Default: 4 to 55)



Matrix 2 of 5 - Any Length



3.10.2 Matrix 2 of 5 Check Digit

The check digit is the last character of the symbol used to verify the integrity of the data. Scan one of the following barcodes to determine whether to include the Matrix 2 of 5 check digit with the barcode data.

Enable Matrix 2 of 5 Check Digit



Disable Matrix 2 of 5 Check Digit*



3.10.3 Transmit Matrix 2 of 5 Check Digit

Scan one of the following barcodes to transmit Matrix 2 of 5 data with or without the check digit.

Transmit Matrix 2 of 5 Check Digit



Do Not Transmit Matrix 2 of 5 Check Digit*



3.11 Inverse 1D

Scan one of the following barcodes to set the 1D inverse engine setting:

- Regular Only** - The engine decodes regular 1D barcodes only
- Inverse Only** - The engine decodes inverse 1D barcodes only
- Inverse Autodetect** - The engine decodes both regular and inverse 1D barcodes.

Note:

This parameter does not apply to GS1 DataBarcode types. The Inverse 1D setting may impact Composite or Inverse Composite decoding. See Composite Inverse.

Regular*



Inverse Only



Inverse Autodetect



3.12 GS1 DataBar

The variants of GS1 DataBar are DataBar-14, DataBar Expanded, and DataBar Limited. The limited and expanded versions have stacked variants. Scan the appropriate barcodes to enable or disable each variant of GS1 DataBar.

3.12.1 GS1 DataBar Omnidirectional

Enable GS1 DataBar Omnidirectional



Disable GS1 DataBar Omnidirectional



3.12.2 GS1 DataBar Limited

Enable GS1 DataBar Limited*

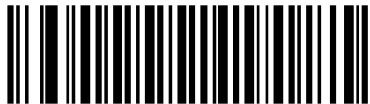

Disable GS1 DataBar Limited



3.12.3 GS1 DataBar Expanded

NOTE: When GS1 DataBar Expanded is enabled GS1 DataBar Expanded Stacked is also enabled.

Enable GS1 DataBar Expanded*



Disable GS1 DataBar Expanded



3.12.4 Convert GS1 DataBar to UPC/EAN/JAN

This parameter only applies to GS1 DataBar-14 and GS1 DataBar Limited symbols not decoded as part of a Composite symbol. Scan Enable Convert GS1 DataBar to UPC/EAN/JAN to strip the leading '010' from DataBar-14 and DataBar Limited symbols encoding a single zero as the first digit, and report the barcode as EAN-13.

For barcodes beginning with between two and five zeros, this strips the leading '0100' and reports the barcode as UPC-A. The [UPC-A Preamble](#) option that transmits the system character and country code applies to converted barcodes. Note that neither the system character nor the check digit can be stripped.

**Enable Convert GS1 DataBar to
UPC/EAN/JAN**



**Disable Convert GS1 DataBar to
UPC/EAN/JAN***



3.12.5 GS1 DataBar Limited Margin Check

The engine offers four levels of decode security for GS1 DataBar Limited barcodes. There is an inverse relationship between the level of margin check and engine aggressiveness. Increasing the level of margin check can reduce scanning aggressiveness, so select only the level of margin check necessary.

- **Margin Check Level 1** – No clear margin required. This complies with the original GS1 standard, yet can result in erroneous decoding of a DataBar Limited barcode when scanning some UPC symbols that start with digits 9 and 7.
- **Margin Check Level 2** – Automatic risk detection. This level of margin check can result in erroneous decoding of DataBar Limited barcodes when scanning some UPC symbols. If a misdecode is detected, the engine operates in Level 3 or Level 1.
- **Margin Check Level 3** – Margin check level reflects the newly proposed GS1 standard that requires a five times trailing clear margin.
- **Margin Check Level 4** – Security level extends beyond the standard required by GS1. This level of margin check requires a five times leading and trailing clear margin.

GS1 DataBar Limited Margin Check Level 1



GS1 DataBar Limited Margin Check Level 2



GS1 DataBar Limited Margin Check Level 3*



GS1 DataBar Limited Margin Check Level 4



3.12.6 GS1 DataBar Expanded Security Level

The engine offers four levels of decode security for GS1 DataBar Expanded barcodes.

- **Security Level 0** - The engine operates in its most aggressive state, while providing sufficient security decoding most in-spec barcodes.
- **Security Level 1** - This setting eliminates most misdecodes while maintaining reasonable aggressiveness.
- **Security Level 2** - Select this option with greater barcode security requirements if Security Level 1 fails to eliminate misdecodes.
- **Security Level 3** - If you selected Security Level 2 and misdecodes still occur, select this security level to apply the highest safety requirements.

GS1 DataBar Expanded Security Level 0



GS1 DataBar Expanded Security Level 1*



GS1 DataBar Expanded Security Level 2



GS1 DataBar Expanded Security Level 3



3.13 Symbology-Specific Security Features

3.13.1 Redundancy Level

The engine offers four levels of decode redundancy. Select higher redundancy levels for decreasing levels of barcode quality.

As redundancy levels increase, the engine's aggressiveness decreases.

Scan one of the following barcodes to select the redundancy level appropriate for the barcode quality:

- **Redundancy Level 1** - The engine must read the following code types twice before decoding:
 - ◆ Codabar (8 characters or less)
 - ◆ MSI (4 characters or less)
 - ◆ D 2 of 5 (8 characters or less)
 - ◆ I 2 of 5 (8 characters or less)
- **Redundancy Level 2** - The engine must read all code types twice before decoding.
- **Redundancy Level 3** - The engine must read code types other than the following twice before decoding, but must read the following codes three times:
 - ◆ Codabar (8 characters or less)
 - ◆ MSI (4 characters or less)
 - ◆ D 2 of 5 (8 characters or less)
 - ◆ I 2 of 5 (8 characters or less)
- **Redundancy Level 4** - The engine must read all code types three times before decoding.

Redundancy Level 1*

Redundancy Level 2

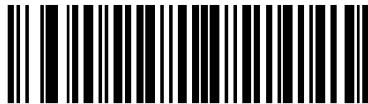
Redundancy Level 3

Redundancy Level 4



3.13.2 Security Level

The engine offers four levels of decode security for delta barcodes, which include the Code 128 family, UPC/EAN/JAN, and Code 93. Select increasing levels of security for decreasing levels of barcode quality. There is an inverse relationship between security and engine aggressiveness, so choose only that level of security necessary for the application.

- Security Level 0** - The engine operates in its most aggressive state, while providing sufficient security decoding most in-spec barcodes.
- Security Level 1** - This default setting eliminates most misdecodes.
- Security Level 2** - Select this option if Security Level 1 fails to eliminate misdecodes
- Security Level 3** - If you selected Security Level 2 and misdecodes still occur, select this security level.

Note:

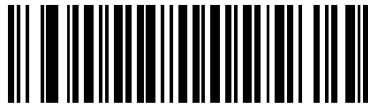
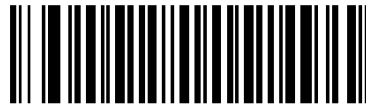
Selecting this option is an extreme measure against mis-decoding severely out-of-spec barcodes, and significantly impairs the decoding ability of the engine. If this level of security is required, try to improve the quality of the barcodes.

Security Level 0**Security Level 1*****Security Level 2****Security Level 3**

3.13.3 1D Quiet Zone Level

This feature sets the level of aggressiveness when decoding barcodes with a reduced quiet zone (the margin on either side of a barcode), and applies to symbologies enabled by a Reduced Quiet Zone parameter. Because higher levels increase the decoding time and risk of misdecodes, Unitech strongly recommends enabling only the symbologies which require higher quiet zone levels, and leaving Reduced Quiet Zone disabled for all other symbologies. Options are:

- 1D Quiet Zone Level 0** - The engine performs normally in terms of quiet zone.
- 1D Quiet Zone Level 1** - The engine performs more aggressively in terms of quiet zone.
- 1D Quiet Zone Level 2** - The engine only requires a quiet zone at the end of barcode for decoding.
- 1D Quiet Zone Level 3** - The engine decodes anything in terms of quiet zone or end of barcode.

1D Quiet Zone Level 0**1D Quiet Zone Level 1*****1D Quiet Zone Level 2****1D Quiet Zone Level 3**

3.13.4 Intercharacter Gap Size

The Code 39 and Codabar symbologies have an intercharacter gap that is typically quite small. Due to various barcode printing technologies, this gap can grow larger than the maximum size allowed, preventing the engine from decoding the symbol. If this problem occurs, scan the **Large Intercharacter Gaps** parameter to tolerate these out-of-specification barcodes.

Normal Intercharacter Gaps*



Large Intercharacter Gaps



3.14 Composite

3.14.1 Composite CC-C

Scan one of the following barcodes to enable or disable Composite barcodes of type CC-C.

Enable CC-C



Disable CC-C*



3.14.2 Composite CC-A/B

Scan one of the following barcodes to enable or disable Composite barcodes of type CC-A/B.

Enable CC-A/B



Disable CC-A/B*



3.14.3 Composite TLC-39

Scan one of the following barcodes to enable or disable Composite barcodes of type TLC-39.

Enable TLC39



Disable TLC39*



3.14.4 Composite Inverse

Select an option to set Composite for either regular decode or inverse decode. This mode only supports Composite Inverse that includes DataBar combined with CCAB, and does not support other 1D/2D combinations.

For this parameter to function, first enable [Composite CC-A/B](#).

- **Regular Only** - The engine decodes regular Composite barcodes only. Before selecting this, set [Inverse 1D](#) to Regular Only or Inverse Autodetect.
- **Inverse Only** - The engine decodes inverse Composite barcodes only. This mode only supports Composite Inverse that includes DataBar combined with CCAB, and does not support other 1D/2D combinations. Before selecting this, first enable [Composite CC-A/B](#), and set [Inverse 1D](#) to Inverse Only or Inverse Autodetect.

Regular Only*



Inverse Only



3.14.5 UPC Composite Mode

Select an option for linking UPC symbols with a 2D symbol during transmission as if they were one symbol:

- **UPC Never Linked** –
Transmit UPC barcodes regardless of whether a 2D symbol is detected.
- **UPC Always Linked** –
Transmit UPC barcodes and the 2D portion. If 2D is not present, do not transmit the barcode
- **Autodiscriminate UPC Composites** –
The engine determines if there is a 2D portion, then transmits the UPC, as well as the 2D portion if present.

UPC Never Linked*



UPC Always Linked



Autodiscriminate UPC Composites

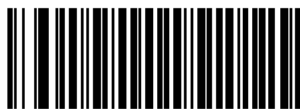

3.15 2D Symbologies

3.15.1 PDF417

Scan one of the following barcodes to enable or disable PDF417.

Enable PDF417*



Disable PDF417

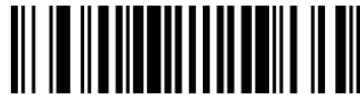

3.15.2 MicroPDF417

Scan one of the following barcodes to enable or disable MicroPDF417.

Enable MicroPDF417



Disable MicroPDF417 *



3.15.3 Code 128 Emulation

Enable this parameter to transmit data from certain MicroPDF417 symbols as Code 128. You must enable [AIM Code ID Character](#) for this parameter to work.

NOTE: *Linked MicroPDF codewords 906, 907, 912, 914, and 915 are not supported. Use GS1 Composites instead.*

Enable Code 128 Emulation to transmit these MicroPDF417 symbols with one of the following prefixes:

-]C1 if the first codeword is 903-905
-]C2 if the first codeword is 908 or 909
-]C0 if the first codeword is 910 or 911

Disable Code 128 Emulation to transmit these MicroPDF417 symbols with one of the following prefixes:

-]L3 if the first codeword is 903-905
-]L4 if the first codeword is 908 or 909
-]L5 if the first codeword is 910 or 911

Scan one of the following barcodes to enable or disable Code 128 Emulation.

Enable Code 128 Emulation



Disable Code 128 Emulation *



3.15.4 Data Matrix

Scan one of the following barcodes to enable or disable Data Matrix.

Enable Data Matrix*



Disable Data Matrix



3.15.5 Data Matrix Inverse

Scan one of the following barcodes to select the Data Matrix inverse engine setting:

- **Regular Only** - The engine decodes regular Data Matrix barcodes only.
- **Inverse Only** - The engine decodes inverse Data Matrix barcodes only.
- **Inverse Autodetect** - The engine decodes both regular and inverse Data Matrix barcodes.

Regular Only



Inverse Only



Inverse Autodetect*



3.15.6 Decode Data Matrix Mirror Images

Scan one of the following barcodes to select an option for decoding mirror image Data Matrix barcodes:

- **Never** - Do not decode Data Matrix barcodes that are mirror images.
- **Always** - Decode only Data Matrix barcodes that are mirror images.
- **Auto** - Decode both mirrored and unmirrored Data Matrix barcodes.

Never



Always



Auto*



3.15.7 Maxicode

Scan one of the following barcodes to enable or disable Maxicode.

Enable Maxicode



Disable Maxicode*



3.15.8 QR Code

Scan one of the following barcodes to enable or disable QR Code.

Note: *Inverse QR barcodes decode if QR Code is enabled.*

Enable QR Code*



Disable QR Code



3.15.9 GS1 QR Code

Scan one of the following barcodes to enable or disable GS1 QR Code.

Enable GS1 QR Code*



Disable GS1 QR Code



3.15.10 Micro QR Code

Scan one of the following barcodes to enable or disable Micro QR Code.

Enable Micro QR Code *



Disable Micro QR Code *



3.15.11 Linked QR Mode

Scan one of the following barcodes to select a linked QR mode.

- **Linked QR Only** - Does not decode individual QRs from a set of linked QR codes.
- **Individual QR with Headers** - Decodes individual QRs from a set of linked QR codes and keeps the header information and data.
- **Individual QR No Headers** - Decodes individual QRs from a set of linked QR codes and just transmits data without header information.

Linked QR Only *



Individual QR with Headers



Individual QR No Headers



3.15.12 Aztec

Scan one of the following barcodes to enable or disable Aztec.

Note: *Enabling this also enables Linked Aztec.*

Enable Aztec *



Disable Aztec



3.15.13 Aztec Inverse

Scan one of the following barcodes to select the Aztec inverse engine setting:

- Regular Only** - The engine decodes regular Aztec barcodes only.
- Inverse Only** - The engine decodes inverse Aztec barcodes only.
- Inverse Autodetect** - The engine decodes both regular and inverse Aztec barcodes.

Regular Only



Inverse Only



Inverse Autodetect *



3.15.14 Han Xin

Scan one of the following barcodes to enable or disable Han Xin.

Enable Han Xin



Disable Han Xin *



3.15.15 Han Xin Inverse

Scan one of the following barcodes to select a Han Xin inverse engine setting:

- **Regular Only** - The engine decodes Han Xin barcodes with normal reflectance only.
- **Inverse Only** - The engine decodes Han Xin barcodes with inverse reflectance only.
- **Inverse Autodetect** - The engine decodes both regular and inverse Han Xin barcodes.

Regular Only*



Inverse Only



Inverse Autodetect



3.15.16 Grid Matrix

Scan one of the following barcodes to enable or disable Grid Matrix.

Enable



Disable *



3.15.17 Grid Matrix Inverse

Scan one of the following barcodes to select a Grid Matrix inverse engine setting:

- **Regular Only** - The engine decodes regular Grid Matrix barcodes only.
- **Inverse Only** - The engine decodes inverse Grid Matrix barcodes only.
- **Autodiscriminate** - The engine decodes both regular and inverse Grid Matrix barcodes.

Regular Only *



Inverse Only



Autodiscriminate



3.15.18 Grid Matrix Mirror

Scan one of the following barcodes to select a Grid Matrix mirror decoder setting:

- **Regular Only** - The decoder decodes regular Grid Matrix barcodes only.
- **Mirrored Only** - The decoder decodes mirrored Grid Matrix barcodes only.
- **Auto-discriminate** - The decoder decodes both regular and mirrored Grid Matrix barcodes.

Regular Only *



Mirrored Only



Autodiscriminate



3.15.19 GS1 Data Matrix

Scan one of the following barcodes to enable or disable GS1 Data Matrix.

Enable GS1 Data Matrix



Disable GS1 Data Matrix *



3.16 Macro PDF Features

Macro PDF is a special feature for concatenating multiple PDF symbols into one file. The engine can decode symbols encoded with this feature, and can store more than 64 Kb of decoded data from up to 50 MacroPDF symbols.

CAUTION! *When printing, keep each Macro PDF sequence separate, as each sequence has unique identifiers. Do not mix barcodes from several Macro PDF sequences, even if they encode the same data. When scanning a Macro PDF sequence, scan the entire sequence without interruption. When scanning a mixed sequence, two long low beeps (low / low) indicate an inconsistent file ID or inconsistent symbology error.*

Macro PDF User Indications

User Scans	Passthrough All Symbols		Transmit Any Symbol in Set		Buffer All Symbols	
	Beep	T	Beep	T	Beep	T
Last Macro PDF in set	Decode Beep	Y	Decode Beep	Y	Decode Beep	Y
Any Macro PDF in set except last	Decode Beep	Y	Decode Beep	Y	2 Short Low	N
Macro PDF is not in current Set	Decode Beep	Y	2 Long Low	N	2 Long Low	N
Invalid formatted Macro PDF	Decode Beep	Y	2 Long Low	N	2 Long Low	N
Macro PDF from a set has already been scanned	Decode Beep	Y	4 Long Low	N	4 Long Low	N
Out of Macro PDF memory	N/A	-	3 Long Low	N	3 Long Low	N
Any non-Macro PDF scanned during a set	N/A	-	4 Long Low	N	4 Long Low	N
Flush Macro PDF	Low High	N	5 Long Low	N	5 Long Low	Y
Abort Macro PDF	High Low High Low	N	High Low High Low	N	High Low High Low	N

Notes:

1. The beep only sounds if the *BEEPER_ON signal is connected.
 2. The column marked T indicates whether the symbol is transmitted to the host.
- N = No transmission.

3.16.1 Macro PDF Transmit / Decode Mode Symbols

Select one of the following options for handling Macro PDF decoding.

In **Buffer All Symbols** the engine can handle sets of up to 50 maximum-sized Macro PDF symbols. In all other modes there is no limit to the size of the MacroPDF set.

- **Buffer All Symbols / Transmit Macro PDF When Complete:**

This transmits all decode data from an entire Macro PDF sequence only when the entire sequence is scanned and decoded. Use the beeper and LED signals provided with the MS652Plus when using this mode to ensure proper user feedback. If the decode data exceeds the limit of 50 symbols, there is no transmission because the entire sequence was not scanned. Use the parameter [Flush Macro Buffer](#) to purge the buffer.

- **Transmit Any Symbol in Set / No Particular Order:**

This transmits data from each Macro PDF symbol as decoded, regardless of the sequence (although some error handling is performed; see [Macro PDF User Indications](#) and the appropriate Signal Description tables. When selecting this mode, enable [Transmit Macro PDF Control Header](#). Also use the beeper and LED signals provided with the MS652Plus to ensure proper user feedback.

- **Passthrough All Symbols:**

This transmits and decodes all Macro PDF symbols and performs no processing. In this mode the host is responsible for detecting and parsing the Macro PDF sequences.

Use this mode when the engine's BEEPER_ON signal is not used to drive a beeper (see the appropriate signal descriptions tables and the appropriate

Imager Engine Signal Descriptions). In the other modes, some Macro PDF scanning sequences provide audible feedback only, so if BEEPER_ON is not used no user feedback is provided. In [Macro PDF User Indications](#), all actions marked **No Transmission** provide no feedback unless the BEEPER_ON signal is used. By using **Passthrough All Symbols** mode every user decode is transmitted to the host where the host software can provide the appropriate feedback.

**Buffer All Symbols / Transmit Macro
PDF When Complete**



**Transmit Any Symbol in
Set / No Particular Order**



Passthrough All Symbols *



3.16.2 Transmit Macro PDF Control Header

When enabled, this activates transmission of the control header, which contains the segment index and the file ID, in Macro PDF symbols. For example, the field may be: \92800000\725\120\343. The five digits after the \928 are the segment index (or block index), and \725\120\343 is the file ID. Enable this when selecting **Transmit Any Symbol in Set / No Particular Order** for the [Macro PDF Transmit / Decode Mode Symbols](#), and disable this when selecting **Buffer All Symbols / Transmit Macro PDF When Complete**. This parameter has no effect when **Pass through All Symbols** is selected.

Enable Macro PDF**Control Header Transmit *****Disable Macro PDF****Control Header Transmit**

3.16.3 Escape Characters

This enables the backslash (\) character as an Escape character for systems that can process transmissions containing special data sequences. Scan one of the following barcodes to either format special data according to the GLI (Global Label Identifier) protocol, or to disable this parameter. This parameter only affects the data portion of a Macro PDF symbol transmission; the Macro PDF Control Header (if enabled) is always sent with GLI formatting.

GLI Protocol**None ***

3.16.4 Flush Macro Buffer

Scan the following barcode to flush the buffer of all decoded Macro PDF data stored to that point, transmit it to the host device, and abort from Macro PDF mode.

Flush Macro PDF Buffer



3.16.5 Abort Macro Buffer

Scan the following barcode to clear all currently stored Macro PDF data in the buffer without transmission and abort from Macro PDF mode.

Abort Macro PDF Entry



3.16.6 Postal Codes

Scan one of the following barcodes to enable or disable US Postnet.

Enable US Postnet



Disable US Postnet*



3.16.7 US Planet

Scan one of the following barcodes to enable or disable US Planet.

Enable US Planet



Disable US Planet*

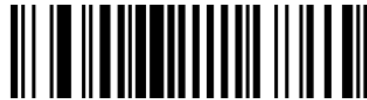

3.16.8 Transmit US Postal Check Digit

Scan one of the following barcodes to select whether to transmit US Postal data, which includes both US Postnet and US Planet, with or without the check digit.

Enable US Planet Transmit

US Postal Check Digit*



Do Not Transmit

US Postal Check Digit



3.16.9 UK Postal

Scan one of the following barcodes to enable or disable UK Postal.

Enable UK Postal



Disable UK Postal*



3.16.10 Transmit UK Postal Check Digit

Scan one of the following barcodes to select whether to transmit UK Postal data with or without the check digit.

Transmit UK Postal Check Digit*



Do Not Transmit UK Postal Check Digit



3.16.11 Japan Postal

Scan one of the following barcodes to enable or disable Japan Postal.

Enable Japan Postal



Disable Japan Postal *



3.16.12 Australia Post

Scan one of the following barcodes to enable or disable Australia Post.

Enable Australia Post



Disable Australia Post*



3.16.13 Australia Post Format

Scan one of the following barcodes to select a format for Australia Post:

- **Autodiscriminate (or Smart mode)** - Decode the Customer Information Field using the N and C Encoding Tables.

NOTE:

This option increases the risk of misdecodes because the encoded data format does not specify the Encoding Table used for encoding.

- **Raw Format** - Output raw bar patterns as a series of numbers 0 through 3.
- **Alphanumeric Encoding** - Decode the Customer Information Field using the C Encoding Table.
- **Numeric Encoding** - Decode the Customer Information Field using the N Encoding Table.

For more information on Australia Post Encoding Tables, refer to the Australia Post Customer Barcoding Technical Specifications available at auspost.com.au.

Autodiscriminate*



Raw Format



Alphanumeric Encoding



Numeric Encoding



3.16.14 Netherlands KIX Code

Scan one of the following barcodes to enable or disable Netherlands KIX Code.

Enable Netherlands KIX Code



Disable Netherlands KIX Code*



3.16.15 USPS 4CB/One Code/Intelligent Mail

Scan one of the following barcodes to enable or disable USPS 4CB/One Code/Intelligent Mail.

**Enable USPS 4CB/
One Code/Intelligent Mail**



**Disable USPS 4CB/
One Code/Intelligent Mail ***



3.16.16 UPU FICS Postal

Scan one of the following barcodes to enable or disable UPU FICS Postal.

Enable UPU FICS Postal



Disable UPU FICS Postal*



3.16.17 Mailmark

Scan one of the following barcodes to enable or disable Mailmark.

Disable Mailmark *

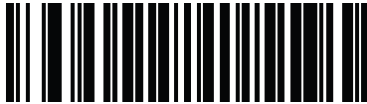

Enable Mailmark



3.17 Set Barcodes Enable/Disable

Scan below barcode to enable / disable barcode setting.

Enable*



Disable



3.18 Parameter Barcode Scanning

Scan one of the following barcodes to select whether to enable or disable the decoding of parameter barcodes, including the Set Defaults barcodes.

Enable Parameter Barcode Scanning*



Disable Parameter Barcode Scanning



3.19 Lock/Unlock Parameter Scanning

This feature locks parameter settings with a 4-digit code to prevent the user from changing parameter values by scanning parameter barcodes. This provides an added level of security not offered via Disable Parameter Scanning.

To lock parameter scanning:

1. Scan the Lock barcode.
2. Scan four barcodes from [Appendix B, Numeric Barcodes](#) that represent the desired code. Enter leading zeros for numbers below 1000, e.g., to program a code of 29, enter 0, 0, 2, 9. A "lock" beep sounds (two long high beeps) in addition to the parameter entry beep.

To unlock parameter scanning:

1. Scan the Unlock barcode.
2. Scan four barcodes from [Appendix B, Numeric Barcodes](#) that represent the correct code. An "unlock" beep sounds (two long low beeps) in addition to the parameter entry beep.

Entering an incorrect code results in a parameter error beep.

Lock



Unlock



3.20 Validate Concatenated Parameter Barcodes

The engine can encounter invalid parameters when using concatenated parameter barcodes intended for different scanner models or different versions of a scanner. This parameter determines how to process concatenated parameter barcodes when the engine encounters an invalid parameter setting in the barcode. Disable this to ignore invalid parameters and configure valid parameters. Enable this to ignore all parameters if one or more is invalid.

**Disable Validate Concatenated
Parameter Barcodes***



**Enable Validate Concatenated
Parameter Barcodes**



3.21 OCR-A

NOTE: OCR is not as secure as a barcode. To decrease OCR misdecodes and speed OCR reading, set an accurate OCR template and character subset, and use a check digit. See [OCR Subset and OCR Template](#).

Scan one of the following barcodes to enable or disable OCR-A.

Enable OCR-A



Disable OCR-A *



3.22 OCR-A Variant

NOTE: Enable OCR-A before setting this parameter. If disabling OCR-A, set the variant to its default (OCR-A Full ASCII).

The font variant sets a processing algorithm and default character subset for the given font. To choose a variant, scan one of the following barcodes. Select the most appropriate font variant to optimize performance and accuracy.

OCR-A supports the following variants:

- OCR-A Full ASCII
! "\$ % () * + , - . / 0 1 2 3 4 5 6 7 8 9 < > A B C D E F G H I J K L M N O P Q R S T U V W X Y Z ^ \
- OCR-A Reserved 1
\$ * + - . / 0 1 2 3 4 5 6 7 8 9 A B C D E F G H I J K L M N O P Q R S T U V W X Y Z
- OCR-A Reserved 2
\$ * + - . / 0 1 2 3 4 5 6 7 8 9 < > A B C D E F G H I J K L M N O P Q R S T U V W X Y Z
- OCR-A Banking
- 0 1 2 3 4 5 6 7 8 9 < > Ψ \mathcal{H} \mathcal{J}

Special banking characters output as the following representative characters:

Ψ outputs as f \mathcal{H} outputs as c \mathcal{J} outputs as h

OCR-A Full ASCII *



OCR-A Reserved 1



OCR-A Reserved 2



OCR-A Banking



3.23 OCR-B

NOTE:

OCR is not as secure as a barcode. To decrease OCR misdecodes and speed OCR reading, set an accurate OCR template and character subset, and use a check digit. See [OCR Subset and OCR Template](#).

Scan one of the following barcodes to enable or disable OCR-B.

Enable OCR-B



Disable OCR-B *



3.24 OCR-B Variant

NOTE: Enable OCR-B before setting this parameter. If disabling OCR-B, set the variant to its default (OCR-B Full ASCII).

OCR-B has the following variants. Select the most appropriate font variant to optimize performance and accuracy.

- OCR-B Full ASCII

!#\$%()*+,-./0123456789<>ABCDEFGHIJKLMN OPQRSTUVWXYZ^_`~

- OCR-B Banking

#+-0123456789<>JNP|

- OCR-B Limited

+,-./0123456789<>ACENPSTVX

- OCR-B ISBN 10-Digit Book Numbers
-0123456789>BCEINPSXz
- OCR-B ISBN 10 or 13-Digit Book Numbers
-0123456789>BCEINPSXz
- OCR-B Travel Document Version 1 (TD1) 3-Line ID Cards
-0123456789<ABCDEFGHIJKLMNOPQRSTUVWXYZ
- OCR-B Travel Document Version 2 (TD2) 2-Line ID Cards
-0123456789<ABCDEFGHIJKLMNOPQRSTUVWXYZ
- OCR-B Travel Document 2 or 3-Line ID Cards Auto-Detect
!#\$%()*+,-./0123456789<>ABCDEFGHIJKLMNOPQRSTUVWXYZ^_`ñ
- OCR-B Passport
-0123456789<ABCDEFGHIJKLMNOPQRSTUVWXYZÑ
- OCR-B Visa Type A
-0123456789<ABCDEFGHIJKLMNOPQRSTUVWXYZ
- OCR-B Visa Type B
-0123456789<ABCDEFGHIJKLMNOPQRSTUVWXYZÑ
- OCR-B ICAO Travel Documents
This allows reading either TD1, TD2, Passport, Visa Type A, or Visa Type B without switching between these options. It automatically recognizes the travel document read.

Scanning any ISBN Book Number automatically applies the appropriate ISBN checksum.

To choose a variant, scan one of the barcodes below. Selecting the following OCR-B variants automatically sets the appropriate [OCR Lines](#). These five

variants invoke extensive special algorithms and checking for that particular document type:

Variant	OCR Lines Setting
Passport	2
TD1 ID Cards	3
TD2 ID Cards	2
Visa Type A	2
Visa Type B	2

NOTE: When setting one of the variants above with both OCR-A and OCR-B enabled, the engine reads the specified travel document but does not read OCR-A. When the OCR-B variant is set back to the default (OCR-B Full ASCII), the engine reads OCR-A.

OCR-B Full ASCII *



OCR-B Banking



OCR-B Limited



OCR-B ISBN 10-Digit Book Numbers



OCR-B ISBN 10 or 13-Digit Book Numbers



OCR-B Travel Document Version 1 (TD1)

3 Line ID Cards



OCR-B Travel Document Version 2 (TD2)

2-Line ID Cards



Travel Document 2 or 3-Line ID Cards

Auto-Detect



OCR-B Passport



OCR-B Visa Type A



OCR-B Visa Type B



OCR-B ICAO Travel Documents



3.25 MICR E13B

NOTE: OCR is not as secure as a barcode. To decrease OCR misdecodes and speed OCR reading, set an accurate OCR template and character subset, and use a check digit. See [OCR Subset and OCR Template](#).

Scan one of the following barcodes to enable or disable MICR E13B.

MICR E 13B uses the following characters:

0 1 2 3 4 5 6 7 8 9 | : ; ' | " | .

TOAD characters (Transit, On Us, Amount, and Dash) output as the following representative characters:

|: outputs as t

|' outputs as a

||" outputs as o

||. outputs as d

Enable MICR E13B



Disable MICR E13B *



3.26 US Currency Serial Number

Scan one of the following barcodes to enable or disable US Currency Serial Number.

NOTE: OCR is not as secure as a barcode. To decrease OCR misdecodes and speed OCR reading, set an accurate OCR template and character subset, and use a check digit. See [OCR Subset](#) and [OCR Template](#).

Enable US Currency



Disable US Currency *



3.27 OCR Orientation

Select one of five options to specify the orientation of the OCR to read:

- 0° to the imaging engine (default)
- 270° clockwise (or 90° counterclockwise) to the imaging engine
- 180° (upside down) to the imaging engine
- 90° clockwise to the imaging engine
- Omnidirectional

Setting an incorrect orientation can cause misdecodes.

OCR Orientation 0° *



OCR Orientation 270° Clockwise



OCR Orientation 180° Clockwise



OCR Orientation 90° Clockwise



OCR Orientation Omnidirectional



3.28 OCR Lines

To select the number of OCR lines to decode, scan one of the following barcodes. Selecting Visas, TD1, or TD2 ID cards automatically sets the appropriate OCR Lines. Also see [OCR-B Variant](#).

OCR 1 Line *



OCR 2 Lines



OCR 3 Lines



3.29 OCR Minimum Characters

To select the minimum number of OCR characters (not including spaces) per line to decode, scan the following barcode, then scan a three-digit number between 003 and 100 using the barcodes in [Appendix B, Numeric Barcodes](#) representing the number of OCR characters to decode. Strings of OCR characters less than the minimum are ignored. The default is 003.

OCR Minimum Characters



3.30 OCR Maximum Characters

To select the maximum number of OCR characters (including spaces) per line to decode, scan the following barcode, then scan a three-digit number between 003 and 100 using the barcodes in [Appendix B, Numeric Barcodes](#) representing the number of OCR characters to decode. Strings of OCR characters greater than the maximum are ignored. The default is 100.

OCR Maximum Characters



3.31 OCR Subset

Create an OCR subset to define a custom group of characters in place of a preset font variant. For example, if scanning only numbers and the letters A, B, and C, create a subset of just these characters to speed decoding. This applies a designated OCR Subset across all enabled OCR fonts.

To set or modify the OCR font subset:

1. Enable the appropriate OCR font(s).
2. Scan the OCR Subset barcode.
3. Scan numbers and letters to form the OCR Subset from [Alphanumeric Barcodes](#).
4. Scan [End of Message](#).

OCR Subset



To cancel an OCR subset, for OCR-A or OCR-B, scan OCR-A Variant Full ASCII, or OCR-B Variant Full ASCII.

For MICR E13B or US Currency Serial Number, create a subset which includes all allowed characters in that character set, or scan an option from the [Default Parameters](#) and re-program the engine.

3.32 OCR Quiet Zone

This option sets the OCR quiet zone. The engine stops scanning a field when it detects a sufficiently wide blank space. The width of this space is defined by the End of Field option. Used with parsers that tolerate slanted characters, the End of Field count is approximately a count of 8 for a character width. For example, if set to 15, then two character widths are an end of line indicator for the parser. Larger end of field numbers requires bigger quiet zones at each

end of text line. To set a quiet zone, scan the following barcode, then scan a two-digit number using the numeric keypad in [Alphanumeric Barcodes](#). The range of the quiet zone is 20-99 and the default is 50, indicating a six-character width quiet zone.

OCR Quiet Zone



3.33 OCR Template

This option creates a template for precisely matching scanned OCR characters to a desired input format. Carefully constructing an OCR template eliminates scanning errors.

To set or modify the OCR decode template, scan the [OCR Template](#) barcode, and then scan barcodes on the following pages that correspond to numbers and letters to form the template expression. Then scan **End of Message**. The default is **54R** which accepts OCR strings containing any character.

OCR Template



End of Message



3.33.1 Required Digit (9)

Only a numeric character is accepted in this position.

Template	Valid data	Valid data	Invalid data
99999	12987	30517	123AB

9



3.33.2 Required Alpha (A)

Only an alpha character is accepted in this position.

Template	Valid data	Valid data	Invalid data
AAAAA	ABCDE	UVWXY	12FGH

A



3.33.3 Require and Suppress (0)

Any character in this position, including space or reject, is suppressed from the output.

Template	Incoming data	Output
990AA	12QAB	12AB

3.33.4 Optional Alphanumeric (1)

An alphanumeric character is accepted in this position if present. Optional characters are not allowed as the first character(s) in a field of like characters.

Template	Valid data	Valid data	Invalid data
99991	1234A	12345	1234<

1



3.33.5 Optional Alpha (2)

An alphanumeric character is accepted in this position if present. Optional characters are not allowed as the first character(s) in a field of like characters.

Template	Valid data	Valid data	Invalid data
AAAA2	ABCDE	WXYZ	ABCD6

2



3.33.6 Alpha or Digit (3)

An alphanumeric character is required in this position to validate the incoming data.

Template	Valid data	Valid data	Invalid data
33333	12ABC	WXY34	12AB<

3



3.33.7 Any Including Space & Reject (4)

Any character is accepted in this position, including space and reject. An underscore (_) represents rejects in the output. This is a good selection for troubleshooting.

Template	Valid data	Valid data
99499	12\$34	34 98

4



3.33.8 Any except Space & Reject (5)

Any character is accepted in this position, except a space or reject.

Template	Valid data	Valid data	Invalid data
55999	A.123	*Z456	A BCD

5



3.33.9 Optional Digit (7)

A numeric character is accepted if present. Optional characters are not allowed as the first character(s) in a field of like characters.

Template	Valid data	Valid data	Invalid data
99977	12345	789	789AB

7



3.33.10 Digit or Fill (8)

Any numeric or fill character is accepted in this position.

Template	Valid data	Valid data	Valid data
88899	12345	>>789	<<789

8



3.33.11 Alpha or Fill (F)

Any alpha or fill character is accepted in this position.

Template	Valid data	Valid data	Valid data
AAAF	ABCXY	LMN>>	ABC<5

F



3.33.12 Optional Space ()

A space is accepted if present. Optional characters are not allowed as the first character(s) in a field of like characters.

Template	Valid data	Valid data	Invalid data
99 99	12 34	1234	67891

Space



3.33.13 Optional Small Special (.)

A special character is accepted if present. Optional characters are not allowed as the first character(s) in a field of like characters. Small special characters are -, and.

Template	Valid data	Valid data	Invalid data
AA.99	MN.35	XY98	XYZ12

.



3.33.14 Other Template Operators

These template operators assist in capturing, delimiting, and formatting scanned OCR data.

Literal String (" and +)

Use either of these delimiting characters surrounding characters from the alphanumeric keyboard in [Alphanumeric Barcodes](#) to define a literal string within a template that must be present in scanned OCR data. There are two characters used to delimit required literal strings; if one of the delimiter characters is present in the desired literal string, use the other delimiter.

Template	Valid data	Invalid data
"35+BC"	35+BC	AB+22

"



+



New Line (E)

To create a template of multiple lines, add E between the template of each single line.

Template	Valid data	Valid data	Invalid data
999EAAAA	321	987	XYZW
	BCAD	ZXYW	12

E



String Extract (C)

This operator combined with others defines a string of characters to extract from the scanned data. The string extract is structured as follows:

CbPe

Where:

- C is the string extract operator
- b is the string begin delimiter
- P is the category (one or more numeric or alpha characters) describing the string representation
- e is the string end delimiter

Values for *b* and *e* can be any scannable character. They are included in the output stream.

Template	Incoming data	Output
C>A>	XQ3>ABCDE>	>ABCDE>
	->ATHRUZ>123	>ATHRUZ>
	1ABCZXYZ	No Output

C



Ignore to End of Field (D)

This operator causes all characters after a template to be ignored. Use this as the last character in a template expression. Examples for the template 999D:

Template	Incoming data	Output
999D	123-PED	123
	357298	357
	193	193

D



Skip Until (P1)

This operator skips over characters until a specific character type or a literal string is detected. It can be used in two ways:

P1ct

Where:

- P1 is the Skip Until operator
- c is the type of character that triggers the start of output
- t is one or more template characters

P1"s"t

Where:

- P1 is the Skip Until operator
- "s" is one or more literal string characters (see [Literal String \(" and +\)](#)) that trigger the start of output
- t is one or more template characters

The trigger character or literal string is included in output from a Skip Until operator, and the first character in the template should accommodate this trigger.

Template	Incoming data	Output
P1"PN"AA9999	123PN9876	PN9876
	PN1234	PN1234
	X-PN3592	PN3592

P



1



Skip Until Not (P0)

This operator skips over characters until a specific character type or a literal string is not matched in the output stream. It can be used in two ways:

P0ct

Where:

- P0 is the Skip Until Not operator
- c is the type of character that triggers the start of output
- t is one or more template characters

P0"s"t

Where:

- P0 is the Skip Until Not operator
- "s" is one or more literal string characters (see [Literal String \(" and +\)](#)) that trigger the start of output
- t is one or more template characters

The trigger character or literal string is not included in output from a Skip Until Not operator.

Template	Incoming data	Output
P0A9999	BPN3456	3456
	PN1234	1234
	5341	No output

Template	Incoming data	Output
P0"PN"9999	PN3456	3456
	5341	No output
	PNPN7654	7654

P



0



Repeat Previous (R)

This operator allows a template character to repeat one or more times, allowing the capture of variable-length scanned data. The following examples capture two required alpha characters followed by one or more required digits:

Template	Incoming data	Output
AA9R	AB3	AB3
	PN12345	PN12345
	32RM52700	No output

R



Scroll Until Match (S)

This operator steps through scanned data one character at a time until the data matches the template.

Template	Incoming data	Output
S99999	AB3	No Output
	PN12345	12345
	32RM52700	52700

S



Multiple Templates

This feature sets up multiple templates for OCR decoding. To do this, follow the procedure described in [OCR Template](#) (scan the [OCR Template](#) barcode, and then barcodes corresponding to numbers and letters to form the template expression, and then scan [End of Message](#)) for each template in the multiple template string, using a capital letter **X** as a separator between templates.

For example, set the [OCR Template](#) as **99999XAAAA** to decode OCR strings of either **12345** or **ABCDE**.

Template Examples

Following are sample templates with descriptions of valid data for each definition.

Field Definition Description

"M"99977	M followed by three digits and two optional digits.
"X"997777"X"	X followed by two digits, four optional digits, and an X.
9959775599	Two digits followed by any character, a digit, two optional digits, any two characters, and two digits.
A55"- "999"- "99	A letter followed by two characters, a dash, three digits, a dash, and two digits.
33A". "99	Two alphanumeric characters followed by a letter, a period, and two digits.
999992991	Five digits followed by an optional alpha, two digits, and an optional alphanumeric.
"PN98"	Literal field - PN98

3.34 OCR Check Digit Modulus

The check digit is the last digit (in the right-most position) in an OCR string and improves the accuracy of the collected data. This option sets OCR module check digit calculation. The calculation is performed on incoming data to determine this check digit, based on the numeric weight of the alpha and numeric characters. See [OCR Check Digit Multiplier](#). If the incoming data does not match the check digit, the data is considered corrupt.

The selected check digit option does not take effect until you set [OCR Check Digit Validation](#).

To choose the Check Digit Modulus, such as 10 for Modulus 10, scan the following barcode, and then scan a three-digit number from 001 to 099 representing the check digit using the numeric keypad in [Alphanumeric Barcodes](#). The default is 1.

OCR Check Digit



3.35 OCR Check Digit Multiplier

This option sets OCR check digit multipliers for character positions. For check digit validation, each character in scanned data has an assigned weight to use in calculating the check digit. The engine OCR ships with the following weight equivalents:

0 = 0	A = 10	K = 20	U = 30
1 = 1	B = 11	L = 21	V = 31
2 = 2	C = 12	M = 22	W = 32
3 = 3	D = 13	N = 23	X = 33
4 = 4	E = 14	O = 24	Y = 34
5 = 5	F = 15	P = 25	Z = 35
6 = 6	G = 16	Q = 26	Space = 0
7 = 7	H = 17	R = 27	
8 = 8	I = 18	S = 28	
9 = 9	J = 19	T = 29	

All other characters are equivalent to one (1).

You can define the multiplier string if it is different from the default.

121212121212 (default)

123456789A (for ISBN, Product Add Right to Left. See [OCR Check Digit Validation](#))

For example:

ISBN	0	2	0	1	1	8	3	9	9	4
Multiplier	10	9	8	7	6	5	4	3	2	1
Product	0	18	0	7	6	40	12	27	18	4
Product add	0 +	18 +	0 +	7 +	6 +	40 +	12 +	27 +	18 +	4 = 132

ISBN uses Modulus 11 for the check digit. In this case, 132 is divisible by 11, so it passes the check digit. To set the check digit multiplier, scan the following barcode, and then scan numbers and letters to form the multiplier string from [Alphanumeric Barcodes](#). Then scan [End of Message](#).

OCR Check Digit Multiplier



3.36 OCR Check Digit Validation

Use the following options to protect against scanning errors by applying a check digit validation scheme.

None

No check digit validation, indicating no check digit is applied. This is the default.

No Check Digit *



3.36.1 Product Add Left to Right

Each character in the scanned data is assigned a numeric value (see [OCR Check Digit Multiplier](#)). Each digit representing a character in the scanned data is multiplied by its corresponding digit in the multiplier, and the sum of these products is computed. The check digit passes if this sum modulo Check Digit Modulus is zero.

Example:

Scanned data numeric value is 132456 (check digit is 6)

Check digit multiplier string is 123456

Digit	1	3	2	4	5	6	
Multiplier	1	2	3	4	5	6	
Product	1	6	6	16	25	36	
Product add	1+	6+	6+	16+	25+	36=	90

The Check Digit Modulus is 10. It passes because 90 is divisible by 10 (the remainder is zero).

Product Add Left to Right



3.36.2 Product Add Right to Left

Each character in the scanned data is assigned a numeric value (see [OCR Check Digit Multiplier](#)). The check digit multiplier is reversed in order. Each value representing a character in the scanned data is multiplied by its corresponding digit in the reversed multiplier, resulting in a product for each character in the scanned data. The sum of these products is computed. The check digit passes if this sum modulo Check Digit Modulus is zero.

Example:

Scanned data numeric value is 132459 (check digit is 9)

Check digit multiplier string is 123456

Digit	1	3	2	4	5	9
Multiplier	6	5	4	3	2	1
Product	6	15	8	12	10	9
Product add	6+	15+	8+	12+	10+	9= 60

The Check Digit Modulus is 10. It passes because 60 is divisible by 10 (the remainder is 0).

Product Add Right to Left



3.36.3 Digit Add Left to Right

Each character in the scanned data is assigned a numeric value (see [OCR Check Digit Multiplier](#)). Each value representing a character in the scanned data is multiplied by its corresponding digit in the multiplier, resulting in a product for each character in the scanned data. The sum of each individual digit in all of the products is then calculated. The check digit passes if this sum modulo Check Digit Modulus is zero.

Example:

Scanned data numeric value is 132456 (check digit is 6)

Check digit multiplier string is 123456

Digit 1 3 2 4 5 6

Multiplier 1 2 3 4 5 6

Product 1 6 6 16 25 36

Digit add $1+ 6+ 6+ 1+6+ 2+5+ 3+6= 36$

The Check Digit Modulus is 12. It passes because 36 is divisible by 12 (the remainder is 0).

Digit Add Left to Right



3.36.4 Digit Add Right to Left

Each character in the scanned data is assigned a numeric value (see [OCR Check Digit Multiplier](#)). The check digit multiplier is reversed in order. Each value representing a character in the scanned data is multiplied by its corresponding digit in the reversed multiplier, resulting in a product for each character in the scanned data. The sum of each individual digit in all of the products is then calculated. The check digit passes if this sum modulo Check Digit Modulus is zero.

Example:

Scanned data numeric value is 132456 (check digit is 6)

Check digit multiplier string is 123456

Digit	1	3	2	4	5	6	
Multiplier	6	5	4	3	2	1	
Product	6	15	8	12	10	6	
Digit add	6+	1+5+	8+	1+2+	1+0+	6=	30

The Check Digit Modulus is 10. It passes because 30 is divisible by 10 (the remainder is 0).

Digit Add Right to Left



3.36.5 Product Add Right to Left Simple

Remainder

Each character in the scanned data is assigned a numeric value (see [OCR Check Digit Multiplier](#)). The check digit multiplier is reversed in order. Each value representing a character in the scanned data is multiplied by its corresponding digit in the reversed multiplier, resulting in a product for each character in the scanned data. The sum of these products **except for the check digit's product** is computed.

The check digit passes if this sum modulo Check Digit Modulus is equal to the check digit's product.

Example:

Scanned data numeric value is 122456 (check digit is 6)

Check digit multiplier string is 123456

Digit	1	2	2	4	5	6
Multiplier	6	5	4	3	2	1
Product	6	10	8	12	10	6
Product add	6+	10+	8+	12+	10=	46 6

The Check Digit Modulus is 10. It passes because 46 divided by 10 leaves a remainder of 6.

Product Add Right to Left Simple Remainder



3.36.6 Digit Add Right To Left Simple Remainder

Each character in the scanned data is assigned a numeric value (see [OCR Check Digit Multiplier](#)). The check digit multiplier is reversed in order. Each value representing a character in the scanned data is multiplied by its corresponding digit in the reversed multiplier, resulting in a product for each character in the scanned data. The sum of each individual digit in all of the products **except for the check digit's product** is then calculated. The check digit passes if this sum modulo Check Digit Modulus is equal to the check digit's product.

Example:

Scanned data numeric value is 122459 (check digit is 6)

Check digit multiplier string is 123456

Digit	1	2	2	4	5	9
Multiplier	6	5	4	3	2	1
Product	6	10	8	12	10	9
Digit add	6+	1+0+	8+	1+2+	1+0=	19 9

The Check Digit Modulus is 10. It passes because 19 divided by 10 leaves a remainder of 9.

Digit Add Right to Left Simple Remainder



3.36.7 Health Industry - HIBCC43

This is the health industry module 43 check digit standard. The check digit is the modulus 43 sum of all the character values in a given message, and is printed as the last character in a given message.

Example:

Supplier Labeling Data Structure: + A 1 2 3 B J C 5 D 6 E 7 1

Sum of values: $41+10+1+2+3+11+19+12+5+13+6+14+7+1 = 145$

Divide 145 by 43. The quotient is 3 with a remainder of 16. The check digit is the character corresponding to the value of the remainder (see the [Table](#) below), which in this example is 16, or **G**. The complete Supplier Labeling Data Structure, including the check digit, therefore is:

A 1 2 3 B J C 5 D 6 E 7 1 G

Table of Numeric Value Assignments for Computing HIBC LIC Data Format Check Digit

0 = 0	9 = 9	I = 18	R = 27	- = 36
1 = 1	A = 10	J = 19	S = 28	. = 37
2 = 2	B = 11	K = 20	T = 29	Space = 38
3 = 3	C = 12	L = 21	U = 30	\$ = 39
4 = 4	D = 13	M = 22	V = 31	/ = 40
5 = 5	E = 14	N = 23	W = 32	+ = 41
6 = 6	F = 15	O = 24	X = 33	% = 42
7 = 7	G = 16	P = 25	Y = 34	
8 = 8	H = 17	Q = 26	Z = 35	

Health Industry - HIBCC43



3.37 Inverse OCR

Inverse OCR is white or light words on a black or dark background. Select an option for decoding inverse

OCR:

- **Regular Only** - Decode regular OCR (black on white) strings only.
- **Inverse Only** - Decode inverse OCR (white on black) strings only.
- **Autodiscriminate** - Decode both regular and inverse OCR strings.

Regular Only *



Inverse Only



Autodiscriminate



3.38 OCR Redundancy

This option adjusts the number of times to decode an OCR text string before transmission. There are three levels of OCR decode redundancy. There is an inverse relationship between the redundancy level and OCR decoding aggressiveness. Increasing the level of the redundancy can reduce OCR scanning aggressiveness, so select only the level of redundancy necessary.

- **OCR Redundancy Level 1:** This default setting allows the engine to operate in its most aggressive state while providing sufficient accuracy in decoding most in-spec OCR text strings.
- **OCR Redundancy Level 2:** This setting eliminates most misdecodes while maintaining reasonable aggressiveness.
- **OCR Redundancy Level 3:** Select this option with greater redundancy requirements if OCR Redundancy Level 2 fails to eliminate misdecodes.

OCR Redundancy Level 1 *



OCR Redundancy Level 2



OCR Redundancy Level 3



Appendix A – ASCII Character Sets

A-1 ASCII Character Set

ASCII Value (Prefix/Suffix Value)	Full ASCII Code 39 Encode Char	Keystroke	ASCII Character (Applies to RS-232 Only)
1000	%U	CTRL 2	NUL
1001	\$A	CTRL A	SOH
1002	\$B	CTRL B	STX
1003	\$C	CTRL C	ETX
1004	\$D	CTRL D	EOT
1005	\$E	CTRL E	ENQ
1006	\$F	CTRL F	ACK
1007	\$G	CTRL G	BELL
1008	\$H	CTRL H/BACKSPACE ¹	BCKSPC
1009	\$I	CTRL I/HORIZONTAL TAB ¹	HORIZ TAB
1010	\$J	CTRL J	LF/NW LN
1011	\$K	CTRL K	VT
1012	\$L	CTRL L	FF
1013	\$M	CTRL M/ENTER ¹	CR/ENTER
1014	\$N	CTRL N	SO

ASCII Value (Prefix/Suffix Value)	Full ASCII Code 39 Encode Char	Keystroke	ASCII Character (Applies to RS-232 Only)
1015	\$O	CTRL O	SI
1016	\$P	CTRL P	DLE
1017	\$Q	CTRL Q	DC1/XON
1018	\$R	CTRL R	DC2
1019	\$S	CTRL S	DC3/XOFF
1020	\$T	CTRL T	DC4
1021	\$U	CTRL U	NAK
1022	\$V	CTRL V	SYN
1023	\$W	CTRL W	ETB
1024	\$X	CTRL X	CAN
1025	\$Y	CTRL Y	EM
1026	\$Z	CTRL Z	SUB
1027	%A	CTRL [ESC
1028	%B	CTRL \	FS
1029	%C	CTRL]	GS
1030	%D	CTRL 6	RS
1031	%E	CTRL -	US
1032	Space	Space	Space
1033	/A	!	!
1034	/B	"	"
1035	/C	#	#
1036	/D	\$	\$
1037	/E	%	%
1038	/F	&	&
1039	/G	'	'
1040	/H	((
1041	/I))
1042	/J	*	*
1043	/K	+	+

ASCII Value (Prefix/Suffix Value)	Full ASCII Code 39 Encode Char	Keystroke	ASCII Character (Applies to RS-232 Only)
1044	/L	.	.
1045	-	-	-
1046	.	.	.
1047	/o	/	/
1048	0	0	0
1049	1	1	1
1050	2	2	2
1051	3	3	3
1052	4	4	4
1053	5	5	5
1054	6	6	6
1055	7	7	7
1056	8	8	8
1057	9	9	9
1058	/Z	:	:
1059	%F	;	;
1060	%G	<	<
1061	%H	=	=
1062	%I	>	>
1063	%J	?	?
1064	%V	@	@
1065	A	A	A
1066	B	B	B
1067	C	C	C
1068	D	D	D
1069	E	E	E
1070	F	F	F
1071	G	G	G
1072	H	H	H

ASCII Value (Prefix/Suffix Value)	Full ASCII Code 39 Encode Char	Keystroke	ASCII Character (Applies to RS-232 Only)
1073	I	I	I
1074	J	J	J
1075	K	K	K
1076	L	L	L
1077	M	M	M
1078	N	N	N
1079	O	O	O
1080	P	P	P
1081	Q	Q	Q
1082	R	R	R
1083	S	S	S
1084	T	T	T
1085	U	U	U
1086	V	V	V
1087	W	W	W
1088	X	X	X
1089	Y	Y	Y
1090	Z	Z	Z
1091	%K	[[
1092	%L	\	\
1093	%M]]
1094	%N	^	^
1095	%O	_	_
1096	%W	`	`
1097	+A	a	a
1098	+B	b	b
1099	+C	c	c
1100	+D	d	d
1101	+E	e	e

ASCII Value (Prefix/Suffix Value)	Full ASCII Code 39 Encode Char	Keystroke	ASCII Character (Applies to RS-232 Only)
1102	+F	f	f
1103	+G	g	g
1104	+H	h	h
1105	+I	i	i
1106	+J	j	j
1107	+K	k	k
1108	+L	l	l
1109	+M	m	m
1110	+N	n	n
1111	+O	o	o
1112	+P	p	p
1113	+Q	q	q
1114	+R	r	r
1115	+S	s	s
1116	+T	t	t
1117	+U	u	u
1118	+V	v	v
1119	+W	w	w
1120	+X	x	x
1121	+Y	y	y
1122	+Z	z	z
1123	%P	{	{
1124	%Q		
1125	%R	}	}
1126	%S	~	~
1127			Undefined
7013			ENTER

A-2 Extended Key Character Set

Extended Keypad	Keystroke
7001	Break
7002	Delete
7003	Pg Up
7004	End
7005	Pg Dn
7006	Pause
7007	Scroll Lock
7008	Backspace
7009	Tab
7010	Print Screen
7011	Insert
7012	Home
7013	Enter
7014	Escape
7015	Up Arrow
7016	Dn Arrow
7017	Left Arrow
7018	Right Arrow

Appendix B – Numeric Barcodes

B-1 Extended Key Character Set

For parameters requiring specific numeric values, scan the appropriately numbered bar code(s).

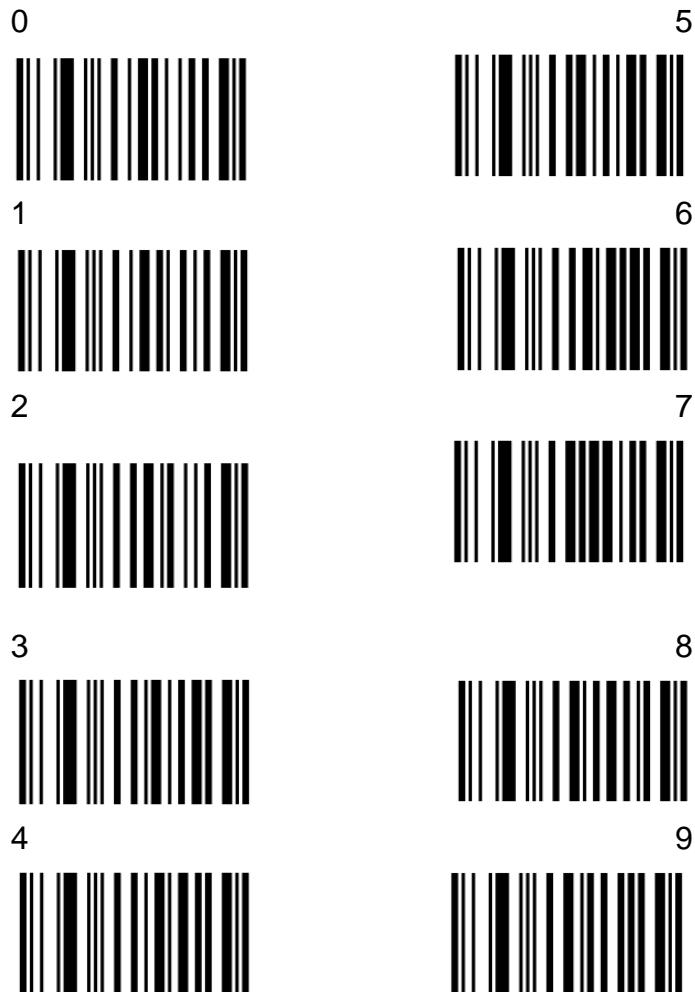

B-2 Cancel

To correct an error or change a selection, scan the bar code below.

Cancel



Appendix C – Alphanumeric BarCodes

C-1 Alphanumeric Barcodes

For parameters requiring specific numeric values, scan the appropriately numbered bar code(s).

Space



#



\$



%



*



+



-



.



/



!



















“















&



‘	(
	
)	:
	
;	<
	
=	>
	
?	@
	
[\
	
]	^
	
—	`
	

NOTE: Do not confuse the following bar codes with those on the numeric keypad.

0		5	
1		6	
2		7	
3		8	
4		9	
End of Message		Cancel	

A



B



C



D



E



F



G



H



I



J



K



L



M



N



O



P



Q



R



S



T



U



V



W



X



Y



Z



a



b



c



d



e



f



g



h



i



j



k



l



m



n



o



p



q



r



s



t



u



v



w



x



y



z



{



|



}



~



Appendix D – Programming Reference

D-1 Symbol Code Identifiers

Symbol Code Characters

Code Character	Code Type
A	UPC-A, UPC-E, UPC-E1, EAN-8, EAN-13
B	Code 39, Code 32
C	Codabar
D	Code 128, ISBT 128, ISBT 128 Concatenated
E	Code 93
F	Interleaved 2 of 5
G	Discrete 2 of 5, or Discrete 2 of 5 IATA
H	Code 11
J	MSI
K	GS1-128
L	Bookland EAN
M	Trioptic Code 39
N	Coupon Code
R	GS1 DataBar Family
S	Matrix 2 of 5
T	UCC Composite, TLC 39
U	Chinese 2 of 5

Code Character	Code Type
V	Korean 3 of 5
X	ISSN EAN, PDF417, Macro PDF417, Micro PDF417
z	Aztec, Aztec Rune
P00	Data Matrix
P01	QR Code, MicroQR
P02	Maxicode
P03	US Postnet
P04	US Planet
P05	Japan Postal
P06	UK Postal
P08	Netherlands KIX Code
P09	Australia Post
P0A	USPS 4CB/One Code/Intelligent Mail
P0B	UPU FICS Postal
P0H	Han Xin
P0X	Signature Capture

D-2 AIM Code Identifiers

Each AIM Code Identifier contains the three-character string] cm where:

] = Flag Character (ASCII 93)

c = Code Character

m = Modifier Character

A. Aim Code Characters

Code Character	Code Type
A	Code 39, Code 39 Full ASCII, Code 32
C	Code 128, ISBT 128, ISBT 128 Concatenated, GS1-128, Coupon (Code 128 portion)
d	Data Matrix
E	UPC/EAN, Coupon (UPC portion)
e	GS1 DataBar Family
F	Codabar
G	Code 93
H	Code 11
h	Han Xin
I	Interleaved 2 of 5
L	PDF417, Macro PDF417, Micro PDF417
L2	TLC 39
M	MSI
Q	QR Code, MicroQR
S	Discrete 2 of 5, IATA 2 of 5
U	Maxicode
z	Aztec, Aztec Rune
X	Bookland EAN, ISSN EAN, Trioptic Code 39, Chinese 2 of 5, Matrix 2 of 5, Korean 3 of 5, US Postnet, US Planet, UK Postal, Japan Postal, Australia Post, Netherlands KIX Code, USPS 4CB/One Code/ Intelligent Mail, UPU FICS Postal, Signature Capture

B. Modifier Characters

The modifier character is the sum of the applicable option values.

Code Type	Option Value	Option
Code 39	0	No check character or Full ASCII processing.
	1	Reader has checked one check character.
	3	Reader has checked and stripped check character.
	4	Reader has performed Full ASCII character conversion.
	5	Reader has performed Full ASCII character conversion and checked one check character.
	7	Reader has performed Full ASCII character conversion and checked and stripped check character.
	Example: A Full ASCII bar code with check character W, A+I+MI+DW, is transmitted as JA7AIMID where 7 = (3+4).	
Trioptic Code 39	0	No option specified at this time. Always transmit 0.
	Example: A Trioptic bar code 412356 is transmitted as]X0412356	
Code 128	0	Standard data packet, no Function code 1 in first symbol position.
	1	Function code 1 in first symbol character position.
	2	Function code 1 in second symbol character position.
	Example: A Code (EAN) 128 bar code with Function 1 character ^{FNC1} in the first position, AIMID is transmitted as]C1AIMID	
I 2 of 5	0	No check digit processing.
	1	Reader has validated check digit.
	3	Reader has validated and stripped check digit.
	Example: An I 2 of 5 bar code without check digit, 4123, is transmitted as]I04123	
Codabar	0	No check digit processing.
	1	Reader has checked check digit.
	3	Reader has stripped check digit before transmission.
	Example: A Codabar bar code without check digit, 4123, is transmitted as]F04123	
Code 93	0	No options specified at this time. Always transmit 0.
	Example: A Code 93 bar code 012345678905 is transmitted as]G0012345678905	
MSI	0	Check digits are sent.
	1	No check digit is sent.
	Example: An MSI bar code 4123, with a single check digit checked, is transmitted as]M14123	

Code Type	Option Value	Option
D 2 of 5	0	No options specified at this time. Always transmit 0.
		Example: A D 2 of 5 bar code 4123, is transmitted as]S04123
UPC/EAN	0	Standard data packet in full EAN format, i.e., 13 digits for UPC-A, UPC-E, and EAN-13 (not including supplemental data).
	1	Two digit supplemental data only.
	2	Five digit supplemental data only.
	3	Combined data packet comprising 13 digits from EAN-13, UPC-A or UPC-E symbol and 2 or 5 digits from supplemental symbol.
	4	EAN-8 data packet.
		Example: A UPC-A bar code 012345678905 is transmitted as]E00012345678905
Bookland EAN	0	No options specified at this time. Always transmit 0.
		Example: A Bookland EAN bar code 123456789X is transmitted as]X0123456789X
ISSN EAN	0	No options specified at this time. Always transmit 0.
		Example: An ISSN EAN bar code 123456789X is transmitted as]X0123456789X
Code 11	0	Single check digit
	1	Two check digits
	3	Check characters validated but not transmitted.
GS1 DataBar Family		No option specified at this time. Always transmit 0. GS1 DataBar-14 and GS1 DataBar Limited transmit with an Application Identifier "01". Note: In GS1-128 emulation mode, GS1 DataBar is transmitted using Code 128 rules (i.e.,]C1).
		Example: A GS1 DataBar-14 bar code 0110012345678902 is transmitted as]e00110012345678902.

Code Type	Option Value	Option
EAN.UCC Composites (GS1 DataBar, GS1-128, 2D portion of UPC composite)		Native mode transmission. Note: UPC portion of composite is transmitted using UPC rules.
	0	Standard data packet.
	1	Data packet containing the data following an encoded symbol separator character.
	2	Data packet containing the data following an escape mechanism character. The data packet does not support the ECI protocol.
	3	Data packet containing the data following an escape mechanism character. The data packet supports the ECI protocol.
		GS1-128 emulation Note: UPC portion of composite is transmitted using UPC rules.
	1	Data packet is a GS1-128 symbol (i.e., data is preceded with]JC1).
PDF417, Micro PDF417	0	Reader set to conform to protocol defined in 1994 PDF417 symbology specifications. Note: When this option is transmitted, the receiver cannot reliably determine whether ECIs have been invoked or whether data byte 92 _{DEC} has been doubled in transmission.
	1	Reader set to follow the ECI protocol (Extended Channel Interpretation). All data characters 92 _{DEC} are doubled.
	2	Reader set for Basic Channel operation (no escape character transmission protocol). Data characters 92 _{DEC} are not doubled. Note: When decoders are set to this mode, unbuffered Macro symbols and symbols requiring the decoder to convey ECI escape sequences cannot be transmitted.
	3	The bar code contains a GS1-128 symbol, and the first codeword is 903-907, 912, 914, 915.
	4	The bar code contains a GS1-128 symbol, and the first codeword is in the range 908-909.
	5	The bar code contains a GS1-128 symbol, and the first codeword is in the range 910-911.

Code Type	Option Value	Option
Data Matrix	0	ECC 000-140, not supported.
	1	ECC 200.
	2	ECC 200, FNC1 in first or fifth position.
	3	ECC 200, FNC1 in second or sixth position.
	4	ECC 200, ECI protocol implemented.
	5	ECC 200, FNC1 in first or fifth position, ECI protocol implemented.
	6	ECC 200, FNC1 in second or sixth position, ECI protocol implemented.
MaxiCode	0	Symbol in Mode 4 or 5.
	1	Symbol in Mode 2 or 3.
	2	Symbol in Mode 4 or 5, ECI protocol implemented.
	3	Symbol in Mode 2 or 3, ECI protocol implemented in secondary message.
QR Code	0	Model 1 symbol.
	1	Model 2 / MicroQR symbol, ECI protocol not implemented.
	2	Model 2 symbol, ECI protocol implemented.
	3	Model 2 symbol, ECI protocol not implemented, FNC1 implied in first position.
	4	Model 2 symbol, ECI protocol implemented, FNC1 implied in first position.
	5	Model 2 symbol, ECI protocol not implemented, FNC1 implied in second position.
	6	Model 2 symbol, ECI protocol implemented, FNC1 implied in second position.
Aztec	0	Aztec symbol.
	C	Aztec Rune symbol.
Han Xin	0	Generic data, no special features are set. The transmitted data does not follow the AIM ECI protocol.
	1	ECI protocol enabled. There is at least one ECI mode encoded. Transmitted data must follow the AIM ECI protocol.