

MS352 (BT) Cordless Image Scanner User Manual



Version: MS352 (BT) _UM_EN_V1.2.2

Notice

Make sure you carefully read the following information to ensure that your barcode scanner is able to perform at the level for which it is designed.

- 1) All software, including firmware, furnished to the user is on a licensed basis.
- 2) The right is reserved to make changes to any software or product to improve reliability, function, or design.
- 3) The material in this manual is subject to change without notice.
- 4) The manufacturer assumes no responsibility for any loss or claims by third parties which may arise from the use of this manual.
- 5) A standard kit contains: a handheld unit, a cradle, a USB cable, and a quick guide.
- 6) Do not throw or drop the scanner or otherwise subject it to strong impact, which can damage the scanner, interrupt program execution, corrupt memory contents, or otherwise interfere with proper operation.
- 7) Use a blunt object to operate the stroke keys. Use of a sharp pointed object can damage stroke keys and cause shorting of internal circuitry.
- 8) Do not remove the battery from the barcode scanner before you read the instructions carefully.
- 9) Sudden temperature changes can cause condensation to form on the scanner's case. Operating the scanner while condensation is present can interfere with proper operation. Take care to avoid conditions that cause the formation of condensation. If condensation does form, wait until it dries completely before using the scanner.
- 10) If multi-clusters are working in the same area, it is strongly recommended that different radio frequency channel numbers are applied to different clusters. While setting up, only the radio frequency channel number of the first handheld unit of a single cluster is required to be set. When the first handheld unit binds to the cradle, the cradle will automatically obtain the radio frequency channel number of the handheld unit. The consecutive joined handheld units will automatically obtain the radio frequency channel number of the cradle.
- 11) In order to obtain constantly good communication quality, when in multi-clusters working mode, the physical space between two cradles is required to be at least 2 meters.
- 12) In order to obtain constantly good communication quality, it is recommended to place the cradle on a higher location, generally more than 1 meter above the ground. If working outdoor, the higher location the better.

Note : Article 10 and 11 are only for MS352

Safety precautions – Danger!

Be sure to read the following safety precautions carefully before trying to use the barcode scanner for the first time. Keep this manual in handy place for future reference.



Danger!

Lithium-ion battery

- 1) Never allow the battery to become wet. Water can create the danger of battery heat emission, explosion, and fire.
- 2) Never use or leave the battery next to open flame, near a stove, or any other area exposed to high heat. Doing so creates the danger of battery heat emission, explosion, and fire.
- 3) Never use the battery with any device other than this unit. Doing so can create the danger of battery heat emission, explosion, and fire.
- 4) Note that the battery's positive (+) and negative (-) terminals must be oriented correctly when it is loaded into the Barcode Scanner. Connecting the battery with its terminals reversed creates the danger of battery fluid leakage, heat emission, explosion, and fire.
- 5) Never dispose of the battery by incinerating it or otherwise expose it to heat. Doing so creates the danger of battery heat emission, explosion, and fire.
- 6) Never allow the positive (+) and negative (-) terminals of the battery to become connected (shorted) by metal. Doing so creates the danger of battery heat emission, explosion, and fire.
- 7) Never transport or store the battery together with a necklace, hair pins or other metal objects. Doing so can short battery terminals, and create the danger of battery heat emission, explosion and fire. Be sure to place the battery in its case whenever transporting or storing it.
- 8) Never throw the battery or otherwise subject it to strong impact. Doing so creates the danger of battery heat emission, explosion, and fire.
- 9) Never pierce the battery with nails, hit it with a hammer, or step on it. Doing so can create the danger of battery heat emission, explosion, and fire.
- 10) Never try to take apart the battery in any way. Doing so creates the danger of battery heat emission, explosion, and fire.
- 11) Use only the specified charger to charge the battery. Use of other types of charger creates the danger of battery heat emission explosion, and fire.

Safety precautions – Warning!



Warning!

Disassembly and modification

Never try to disassemble or modify the unit in any way. High voltage inside creates the danger of electrical shock.

Interior parts and components

Never touch interior high-voltage parts or components. Doing so creates the danger of electrical shock.

Abnormal conditions

Should the unit become hot or start to emit smoke or a strange odor, immediately turn off the power and contact your original dealer. Continued use creates the danger of fire and electrical shock.

Foreign objects

Should any foreign matter ever get into the unit, immediately turn off the power and contact your original dealer. Continued use creates the danger of fire and electrical shock.

Dropping and damage

Should you drop the unit and damage it, immediately turn off the power and contact your original dealer. Continued use creates the danger of fire and electrical shock.

Laser beam

Never look directly into the laser beam. Doing so can cause serious eye damage.

Lithium-ion battery

- 1) Do not put a battery in microwave ovens or pressure cookers. Doing so may cause the battery to overheat, explode or burst into flames.
- 2) Do not use a battery that smells strange, is overheating, is a strange color, or is a strange shape. Doing so may cause the battery to overheat, explode or burst into flames.
- 3) If the amount of time period the battery can serve becomes considerably short, stop using it. It may indicate the possibility of a malfunction in the battery. Continued charging the battery creates the danger of heat emission, explosion, and fire.
- 4) Stop charging the battery after the recommended time even if it is not fully charged. Continuing to charge the battery may cause the battery to over heat, explode or burst into flames.
- 5) If the battery leaks fluid or emits a strange smell, remove it from near heat or flames. Burning may cause the battery to explode or burst into flames. Should fluid from the battery accidentally get into your eyes, do not rub them. Immediately rinse your eyes with clean water such as tap water and then consult a physician immediately.

Cradle with RS-232 cable and adaptor

- 1) Power the cradle only with a power outlet whose voltage matches that marked on the adaptor specified in this manual.
- 2) Avoid conditions that can cause damage or breaks in the power cord. Do not place heavy objects on the power cord. Keep it away from sources of heat. Any of these conditions can damage the power cord, creating the danger of fire and electrical shock.
- 3) Never modify, sharply bend, twist, or pull on the power cord. Doing so creates the danger of fire and electrical shock.
- 4) Use only the AC/DC adaptor and charger specified in this manual. Use of other AC/DC adaptor models or chargers creates the danger of fire and electrical shock.
- 5) Should the power cord ever become severely damaged, contact your original dealer. Use of a damaged electrical cord creates the danger of fire and electrical shock.

Moisture

Keep the Basic Unit and the Barcode Scanner away from vases, planters, cups, glasses and other containers of liquid. Also keep it away from metal. Water and metal getting into the unit creates the danger of fire and electrical shock.

Safety precautions – Caution!



Caution!

Foreign objects

Take care to ensure that metal or combustible objects are not inserted into the openings of the unit. Such objects create the danger of fire and electrical shock.

Location

- 1) Do not locate the unit on a surface that is unstable or uneven. Doing so creates the danger of the unit falling, which can cause personal injury.
- 2) Do not locate the unit in an area subjected to large amounts of humidity or dust. Doing so creates the danger of fire and electrical shock.
- 3) Do not leave the unit for long periods in a car parked in direct sunlight.

Heavy objects

Never place heavy objects on top of the unit. Doing so creates the risk of a loss of balance and the object falling, which can cause personal injury.

Scan window

- 1) Never apply strong pressure to the mirror or subject it to strong impact. Doing so can crack the mirror and create the danger of personal injury.
- 2) Should the mirror ever break, never touch the mirror broken. Doing so can cause personal injury.

Lithium-ion battery

- 1) Never leave the battery in an area expose to direct sunlight, in a car parked in direct sunlight, or any other very hot area. Doing so creates the danger of heat emission and fire, as well as deterioration of battery performance and shortening of its service life.
- 2) Do not use the battery in areas where static electricity is being generated. Doing so creates the danger of battery heat emission, explosion, and fire.
- 3) Temperature ranges for battery use, charging and storage are specified below. Temperatures outside these ranges create the danger of deterioration of battery performance and shortening of its service life as well as fluid leakage and heat generation.
- 4) Operating Temperature: -20°C to 60°C .
- 5) Charging Temperature: 0°C to 45°C .
- 6) Storage Temperature: -20°C to 45°C .
- 7) Should fluid from the battery accidentally get onto clothing or your skin, immediately rinse it off with clean tap water. Prolonged contact with battery fluid can cause skin irritation.
- 8) Keep the battery out of the reach of small children. Do not let small children remove the battery from the charger or the unit it is powering.

Cradle with RS-232 cable and adaptor

- 1) Keep the power cord away from stoves and other sources of extreme heat. Heat can melt the insulation of the power cord and create the danger of fire and electrical shock.
- 2) Never pull on the power cord when unplugging it. Doing so can damage the cord and create the danger of personal injury, fire and electrical shock. Always hold onto the plug when unplugging it from the wall outlet.
- 3) Never touch the plug while your hands are wet. Doing so can create the danger of electrical shock.
- 4) Be sure to unplug the power cord from the wall outlet before moving the Basic Unit. Failure to do so can result in damage to the power cord caused by pulling it, which creates the danger of fire and electrical shock.
- 5) Be sure to unplug the power cord from the wall outlet before cleaning the Basic Unit and charger.
- 6) Be sure to turn the power off and unplug the power cord after use.
- 7) Unplug the power cord from the wall outlet and clean the area around the plugs at least once a year. If dust collects on the AC/DC adaptor, humidity or moisture may cause a fault in the insulation, which may result in a fire.

Contents

1 Specifications	1
1-1 Technical specifications	1
1-2 Default setting for each barcode	3
2 Get started	4
2-1 Cable connector pin-outs descriptions for cradle	4
2-2 Dimensions.....	5
2-3 Parts of the scanner	6
2-4 Charge battery.....	7
2-5 Installation of cradle.....	8
2-5-1 PS/2 keyboard cable	8
2-5-2 USB cable.....	8
2-5-3 RS-232 cable.....	8
3 Programming menus	9
3-1 Example 1: Single-parameter setting by scanning 1D barcodes.....	9
3-2 Example 2: Multiple-parameter setting by scanning a QR code barcode	10
3-3 Wireless communication setting.....	11
3-3-1 Wireless communication setting for handheld unit.....	11
3-3-2 MS352 example.....	14
3-3-3 MS352-BT example.....	17
3-4 Keyboard wedge interface for cradle	19
3-5 RS-232 interface for cradle	23
3-6 USB interface for cradle	24
3-7 Handheld scan & some global settings.....	27
3-8 Indication for handheld unit.....	32
3-9 Decode illumination and decode aiming pattern	33
3-10 Single type of barcode read	35
3-11 DPM, Multiple symbols, Structured append read, etc.	36
3-12 UPC-A.....	37
3-13 UPC-E.....	40
3-14 UPC-E1.....	42
3-15 EAN-13 (ISBN/ISSN).....	44
3-16 EAN-8	45
3-17 Code 39 (Code 32, Trioptic Code 39)	48
3-18 Interleaved 2 of 5.....	51
3-19 Industrial 2 of 5.....	53
3-20 Matrix 2 of 5.....	54
3-21 Codabar	54
3-22 Code 128	57
3-23 UCC/EAN 128	59
3-24 ISBT 128.....	61
3-25 Code 93	61
3-26 Code 11	62
3-27 MSI/Plessey.....	64
3-28 UK/Plessey	66
3-29 China Post.....	66
3-30 China Finance	68
3-31 GS1 DataBar (GS1 DataBar Truncated).....	70
3-32 GS1 DataBar Limited	71
3-33 GS1 DataBar Expanded.....	72
3-34 PDF417.....	73
3-35 MicroPDF417.....	74
3-36 QR Code.....	75
3-37 Data Matrix	76
3-38 Aztec Code	77
3-39 G1-G6 & C1-C2 & FN1 substitution string setting	78
3-40 G1-G4 string position & Code ID position	82
3-41 String transmission	83
4 Test barcode symbols	86
5 Maintenance	90

6 ASCII Table	91
7 Barcode representing non-printable character	91
8 Return default parameters.....	93
9 Display firmware version & radio communication setting	94
10 Configuration alphanumeric entry barcode	95

1 Specifications

1-1 Technical specifications

Handheld unit

Radio Link	MS352:430.0 ~ 431.9 MHz,433.3 ~ 434.7 MHz with adaptive frequency hopping MS352-BT: 2.4-2.5GHz,Bluetooth 4.0,Class 2		
Working Range	MS352:100 meters (open air); MS352-BT:30 meters (open air)		
Dimensions	Length x Width x Depth: 90.2 x 70 x 180 mm		
Weight	210 g		
Color	Gray		
Indicator	LED, Beeper, Vibrator		
Operating Mode	Handheld		
Programming Method	Manual (reading special barcode)		
Program Upgrade	Using Flash Utility software, while a cradle unit is required.		
Input Voltage	5 ± 0.25 VDC		
Current	20 mA (standby), 350 mA (scanning)		
Battery	1400 mAh Lithium-ion battery		
Charge Time	4 hours		
Standby Time	4.5 days		
Working Time	46 hours (1 scan per 5 seconds)		
Image Size	1280 x 800 pixels		
Field of View	Horizontal: 42°, vertical: 26.5°		
Scanning Angle	±70°, ±75°, 360° (Skew, Pitch, Roll)		
Print Contrast	20% minimum reflectance difference		
Decoding Capability	1D: UPC-A, UPC-E, UPC-E1, EAN-13, EAN-8, ISBN (Bookland EAN), ISSN, Code 39, Code 39 full ASCII, Code 32, Trioptic Code 39, Interleaved 2 of 5, Industrial 2 of 5, Matrix 2 of 5, Codabar (NW7), Code 128, UCC/EAN 128, ISBT 128, Code 93, Code 11 (USD-8), MSI/Plessey, UK/Plessey, China Post, China Finance, GS1 DataBar (formerly RSS) variants		
	2D: PDF417, MicroPDF417, QR code, DataMatrix, Aztec Code		
Minimum Resolution	HD: 1D (Code 39): 3 mil, 2D (QR): 5 mil SR: 1D (Code 39): 4 mil, 2D (PDF417): 6.7 mil		
Decoding Depth		High density series (HD)	Standard range series (SR)
	3 mil Code39 (3 chars)	10 mm – 61 mm	/
	4 mil Code 128 (9 chars)	5 mm – 88 mm	55 mm – 106 mm
	5 mil Code39 (3 chars)	0 mm – 108 mm	43 mm – 141 mm
	10 mil Code39 (3 chars)	0 mm – 167 mm	0 mm – 310 mm
	13 mil UPC (6 chars)	0 mm – 179 mm	0 mm – 335 mm
	20 mil Code39 (1 char)	10 mm – 253 mm	8 mm – 480 mm
	5 mil QR (40 chars)	7 mm – 65 mm	/
	6.7 mil PDF417 (20 chars)	0 mm – 105 mm	37 mm – 145 mm

	10 mil QR (20 chars)	0 mm – 134 mm	0 mm – 168 mm
	20 mil QR (20 chars)	0 mm – 215 mm	0 mm – 345 mm
Temperature	0° to 50°C (32° to 120°F), operating -40° to 60°C (-40° to 140°F), storage		
Humidity	5% to 95% (non-condensing)		
Safety	EMC: EN55022, EN55024 Electrical Safety: EN60950-1 Photobiological Safety: EN62471:2008 Illumination: 0~100,000 LUX Protection Class: IP51 Drop Resistance: Withstands multiple 1.5 m (5 ft.) drops to concrete		

Note: Test condition: temperature at 27°C, sunny day, and visibility of 5 kilometers. Natural surroundings significantly affect the communication distance in practice. The distance drops quickly in the rainy, high-humidity, or heavy haze day; radio interference also shortens the communication distance.

Cradle

Input Voltage	5 ± 0.25 VDC
Current	60 mA (working), 500 mA (charging)
Cable	Straight 2.0 m (PS/2) / Straight 1.5 m (USB) / Straight 2.0 m (RS-232)
Dimensions	Length x Width x Depth: 118 x 89.5 x 74 mm
Weight	140 g (without cable)
Indicator	LED
Programming Method	Manual (reading special barcode)
Program Upgrade	PC online using Flash Utility software.
Temperature	0° to 50°C (32° to 120°F), operating -40° to 60°C (-40° to 140°F), storage
Humidity	5% to 95% (non-condensing)
Drop Resistance	Unit functions normally after repeated 1.5 m (5 ft.) drops to concrete

1-2 Default setting for each barcode

Code type	Read enable	Check digit verification	Check digit transmission	Min. code length	Proprietary code ID	AIM code ID
UPC-A	√	√	√	(12) ²	A	JEm
UPC-E	√	√	√	(8) ²	D	JEm
UPC-E1	√	√	√	(8) ²	D	JEm
EAN-13	√	√	√	(13) ²	A	JEm
EAN-8	√	√	√	(8) ²	C	JEm
ISBN (Bookland EAN) / ISSN ¹	√	√	√	(13) ²	B	JEm
Code 39	√	-	-	1	M	JAm
Interleaved 2 of 5	√	-	-	6	I	JIm
Industrial 2 of 5	-	-	-	4	H	JIm
Matrix 2 of 5	√	-	-	6	X	JIm
Codabar	√	-	-	4	N	JFm
Code 128	√	√	-	1	K	JCm
ISBT 128	√	√	-	1	K	JCm
Code 93	√	√	-	1	L	JGm
Code 11	-	√	-	4	V	-
MSI/Plessey	-	-	-	4	O	JMm
UK/Plessey	-	√	-	1	U	JMm
UCC/EAN 128	√	√	-	1	K	JCm
China Post	√	-	-	(11) ²	T	JIm
China Finance	√	-	-	(10) ²	Y	-
GS1 DataBar	√	-	-	(16) ²	R	Jem
GS1 DataBar Truncated ³	√	-	-	(16) ²	R	Jem
GS1 DataBar Limited	√	-	-	(16) ²	R	Jem
GS1 DataBar Expanded	√	-	-	1	R	Jem
PDF417	√	-	-	-	-	-
MicroPDF417	√	-	-	-	-	-
DataMatrix	√	-	-	-	-	-
QR code	√	-	-	-	-	-
Aztec Code	√	-	-	-	-	-

Note: ¹The settings for ISBN/ISSN and EAN-13 must be the same except the code ID.

² Fixed-length barcodes.

³The settings for GS1 DataBar Truncated and GS1 DataBar must be the same.

2 Get started

2-1 Cable connector pin-outs descriptions for cradle

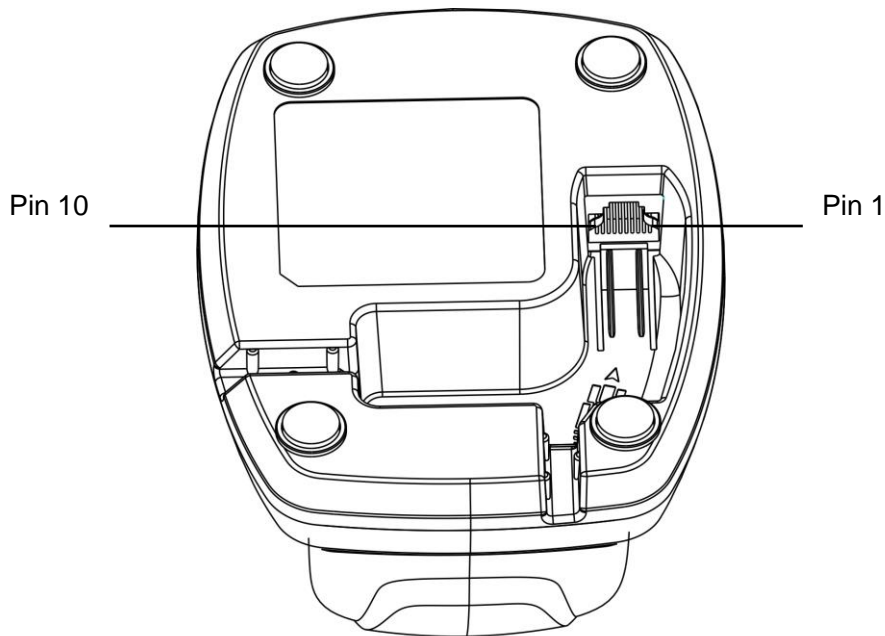

Figure 2-1 Cable connector interface pin-outs

The pin-outs descriptions in Table 2-1 apply to the cable connector on the cradle and are for reference only.

Table 2-1 Cable connector pin-outs descriptions

Pin	RS232	Keyboard (PS/2)	USB
1	Power (+5V)	Power (+5V)	Power (+5V)
2	+3.3V (for interface auto selection purpose)	Ground (for interface auto selection purpose)	+3.3V (for interface auto selection purpose)
3	Ground	Ground	Ground
4	+3.3V (for interface auto selection purpose)	Reserved	Ground (for interface auto selection purpose)
5	TxD	KeyClock	Reserved
6	RxD	KeyData	Reserved
7	Reserved	TermClock	Reserved
8	Reserved	TermData	Reserved
9	CTS	Reserved	D-
10	RTS	Reserved	D+

Note: Voltage level of all RS232 Pin-outs (RxD, TxD, CTS and RTS) is 0V for logic low and 3.3V for logic high.

2-2 Dimensions

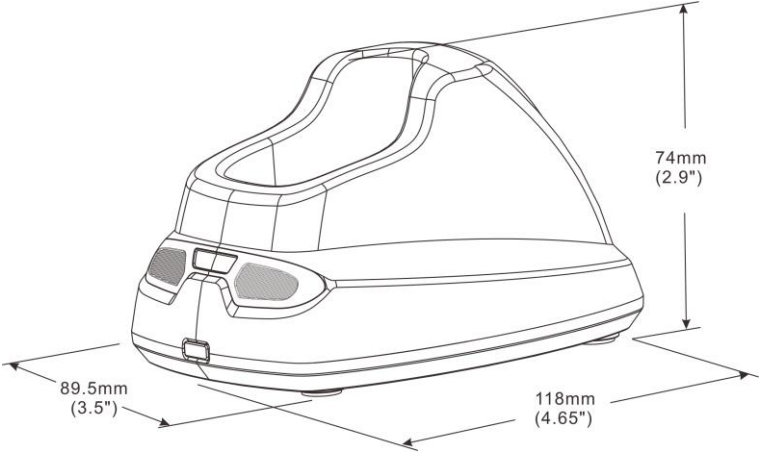
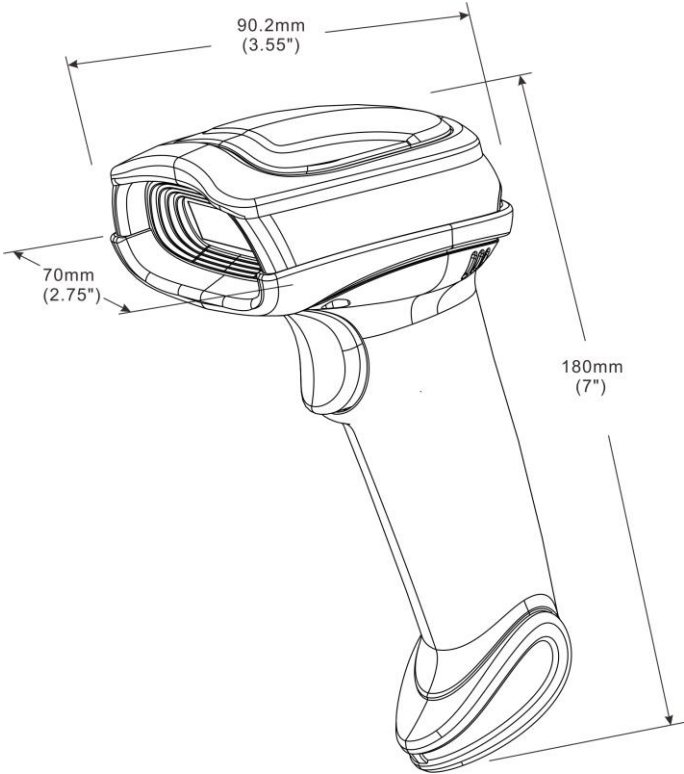

2-3 Parts of the scanner



Figure 2-2 Handheld unit

- ① Scan window
- ② Trigger (Press to trigger / Long press 2 seconds to turn on)
- ③ Beeper
- ④ Power indicator (Blue LED)
- ⑤ Successful decoding indicator (Green LED) / Communication fail indicator (Red LED) / Charging indicator (Red LED)



Figure 2-3 Cradle

- ⑥ Power indicator (Blue LED)
- ⑦ Communication indicator (Green LED)
- ⑧ Key (Long press 2 seconds to restore factory default setting of cradle)

2-4 Charge battery

1. Please charge the battery before the first time of use. The charge indicator (red LED) on the handheld unit is turned on when the charging is in process. When the charging process completes, the red LED is turned off.
 2. Charging time: 4 hours for fully charged.
 3. You can charge the battery via a USB port on the device or a 5 VDC power adapter.
- Note: The 5 VDC power adapter is an optional accessory.

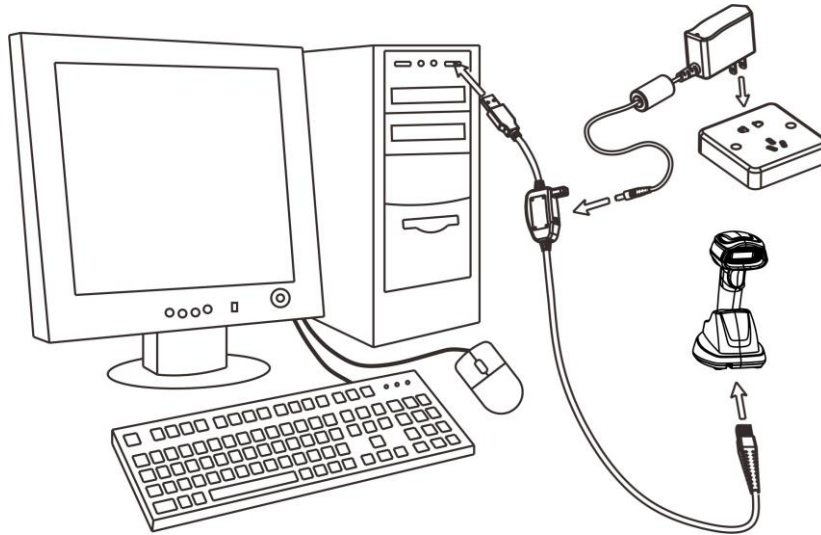

Figure 2-4

2-5 Installation of cradle

Note: If any of the below operation is incorrect, turn off the power immediately and check the scanner for any improper connections. Go through all steps again.

2-5-1 PS/2 keyboard cable

Plug one end of the PS/2 keyboard cable to the cradle, one end to PS/2 port on PC, and one end to the keyboard.

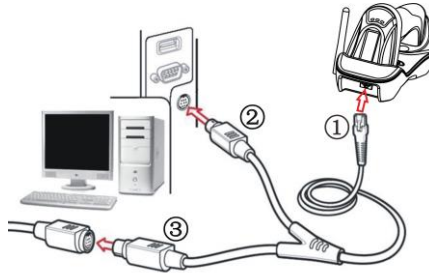

2-5-2 USB cable

- 1) Plug one end of the USB cable to the cradle. Plug the other end into the USB port of the computer.
- 2) Windows gives message on “new hardware found – USB HID input device found”, then driver will be installed on request.
- 3) After successfully installing the new hardware, message will be given: “hardware installed successfully and ready to use”.
- 4) If any problem encounters during the installation process, please unplug the USB cable from the computer and repeat step 1) and 2).

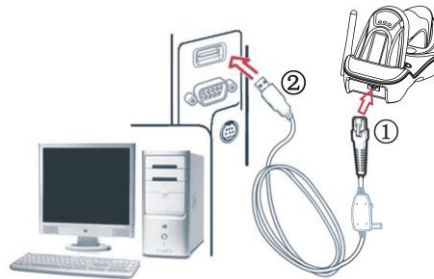

2-5-3 RS-232 cable

- 1) Connect the DB9 serial communication cable with the cradle and the COM port of the computer.
- 2) Plug the output of the AC/DC adaptor into the power terminal of on the cradle. Plug the AC/DC adaptor provided by the manufacturer into an electrical outlet.

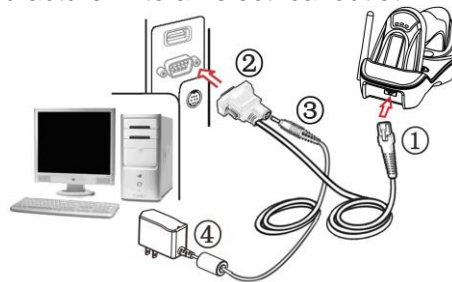

3 Programming menus

3-1 Example 1: Single-parameter setting by scanning 1D barcodes

Important notes:

1. During the process of programming, LED is lighting to indicate the programming correctness. LED will go off if any incorrect programming operation performed.
2. After each successful programming, LED will go off and the scanner will beep twice.
3. Throughout the programming barcode menus, the factory default settings are indicated with asterisks (*).

Two programming modes have been provided as bellows:

① Single-scan setting

- Scan the appropriate Single-scan setting (e.g. %0101D00%) according to the user's demand.

Example: To set Flow control to be XON/XOFF.

Steps: Scan the following barcode.



② Multiple-scan setting

- Step 1. Scan the Option barcode (e.g. %0101M%) according to the user's demand.
- Step 2. To the right of the option barcode, the necessary alphanumeric inputs are listed. Scan two alphanumeric entries from 0 to 9 or A to F, refer to [10 Configuration alphanumeric entry barcode](#).
- Step 3. Repeat Step 2, if more user parameters input are required.
- Step 4. Scan the %END% barcode, listed on the lower left hand corner of each parameter setting part.

Example: To set Flow control to be XON/XOFF.

Steps: Referring to [3-5 RS-232 interface for cradle](#), scan the following barcodes in order.



3-2 Example 2: Multiple-parameter setting by scanning a QR code barcode

User can customize a QR code barcode to set multiple parameters. The scanner can set multiple parameters by scanning this single QR code barcode.

1. The data format of the QR code barcode is as following.

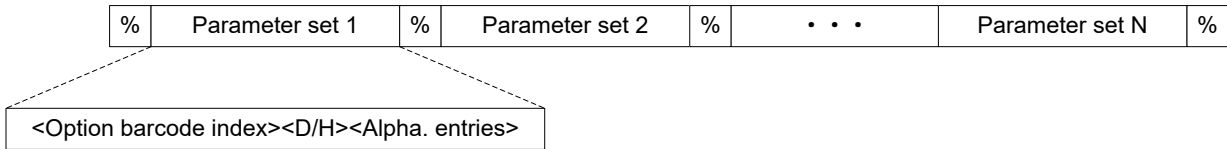

Note that:

- <Option barcode index> means the corresponding 4 digits of Option barcode.
- <D/H> means “D” or “H” character. D means that the type of alphanumeric entry is decimal; and H means that the type of alphanumeric entry is hexadecimal.
- <Alpha. entries> is a character string with various length of 2, 4, or other values.

Example: Set 0401->03 (decimal); 8002->0D0A (hexadecimal); 8202->01 (decimal). The customized QR code barcode contents and symbol are as following.

`%0401D03%8002H0D0A%8202D01%`



2. Notes of making QR code barcode

The model is chosen as M2. Other requirements, e.g. ECC level, Start mode, etc, are not specified.

Other notes

- 1- The contents of a QR code barcode can include several same <Option barcode index> associated with same or different <Alpha. entries>. In the case of with different <Alpha. entries>, the latest <Alpha. entries> is the valid one.
- 2- If any one of the parameter settings is invalid, the total setting is failed. The invalid setting can be caused by one of the following problems: invalid <Option barcode index>, invalid type of <D/H>, invalid type, length or value range of <Alpha. entries>, etc.

3-3 Wireless communication setting

3-3-1 Wireless communication setting for handheld unit

Handheld unit RF channel No.: The scanner offers 16 different radio frequency channels for the data transmission between handheld unit and cradle. The number of channel can be increased.

Note: only support for MS352

Batch data mode:

Disable- Do not batch data. The handheld unit attempts to transmit every scanned barcode. If the transmission is failed, the barcode data is ignored.

Out-of-range batch— The handheld unit starts storing barcode data when it loses its connection to a remote device (for example, when a user holding the handheld unit walks out of range). Data transmission is triggered by reestablishing the connection with the cradle (for example, when a user holding the handheld unit walks back into range).

Standard batch- The handheld unit starts storing barcode data after “%%EBM” (*Enter Batch Mode*) is scanned. Data transmission is triggered by scanning “%%SBD” (*Send Batch Data*).

In Out-of-range batch or Standard batch modes, calculate the number of barcodes the handheld unit can store as follows:

Number of storable barcodes = 16,384 bytes of memory / (number of characters in the barcode + 2).

Beep on reconnect attempt: This feature is active only when the Out-of-range batch operating mode is selected. If this feature is enabled, the beeper emits 4 short beeps every 5 seconds while the reconnection attempt is in progress.

Radio connection checking interval: This feature is active only when the Out-of-range batch operating mode is selected. The handheld unit checks the radio communication with the cradle once within the time interval.

Save data at low-battery or power-off: If it is enabled, the handheld unit will save data to memory while the battery is low or before the power is off.

Low battery indicator: If it is enabled, while the power is low, the power LED on the handheld unit flashes 5 times, and the beeper emits 5 beepers for every 10 minutes or 200 scans. In this battery low status, the power LED flashes 2 times by pulling the scanner trigger.

Enter sleeping mode interval: If it is enabled, the handheld unit will enter sleeping mode while no operation beyond the time interval defined; the handheld unit will return to normal mode by pulling the scanner trigger.

Enter transmitting data mode interval: There is no continuous scanning motion time interval of before the domination handheld unit entering the barcode transmission status. By default when out of range, if there is barcode data awaiting transmission, the handheld unit will try to transmit data to the cradle after no scanning motion occurs for 5 seconds. This can avoid conflict between transmission of barcode data and scanning barcode motion requested by user.

Interval for radio communication: An unsuccessful transmission is verified while the handheld unit has not received data beyond the interval. If a RS232 cable is used, this value should be set not less than feedback delay of RS232 serial port transmission.

Inform the result of wired transmission for handheld unit: If this option is enabled, the cradle will only inform the handheld unit the success of data transmission after the data has been successfully transmitted from cradle to host PC.

Multiple-scan setting			Single-scan setting
Option bar code	Option	Alpha. entry	
Handheld unit RF channel No.  %0701M%	02-16	02-16	
		06*	 %0701D06% *
Batch data mode  %0705M%	Disable	00*	 %0705D00% *
	Out-of-range batch	01	 %0705D01%
	Standard batch	02	 %0705D02%
Beep on reconnect attempt  %0706M%	Disable	00*	 %0706D00% *
	Enable	01	 %0706D01%
Radio connection checking interval  %0707M%	00-FF ₁₆ (second)	00-FF ₁₆	
		03*	 %0707H03% *
Save data at low-battery or power-off  %0708M%	Disable	00*	 %0708D00% *
	Enable	01	 %0708D01%
Low battery indicator  %0709M%	Disable	00	 %0709D00%
	Enable	01*	 %0709D01% *
Enter sleeping mode interval  %0710M%	00-FF ₁₆ (minute)	00-FF ₁₆	
		0F ₁₆ *	 %0710H0F% *
Enter transmitting data mode interval  %0711M%	00-FF ₁₆ (minute)	00-FF ₁₆	
		0F ₁₆ *	 %0711H0F% *
Interval for radio communication  %0713M%	02-20 (second)	02-20	
		02*	 %0713D02% *
Inform the result of wired transmission for handheld unit  %0714M%	Disable	00*	 %0714D00% *
	Enable	01	 %0714D01%



Enter batch mode

%%%EBM

Send batch data

%%%SBD

Bind

%%BIND

Join

%%JOIN

Show channel information of handheld unit

%%%SCI

Show channel information of Cradle

%%BSCI

Disconnect the bluetooth

@DISCONNECT@

3-3-2 MS352 example

Example 1: One handheld unit and one cradle

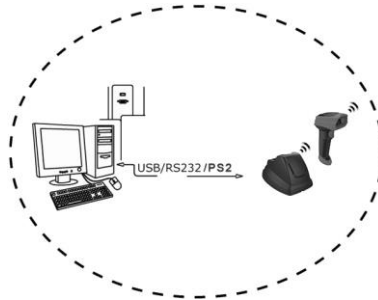

The following takes channel No.5 for instance.

Step 1): Set **Handheld unit RF channel No.** of the handheld unit to 5.



or



Step 2): Scan the following barcode to bind the handheld unit with the cradle.



Firmly position the handheld unit onto the cradle. Within 10 seconds, two beeps will be emitted to signal that the cradle has been paired to the handheld unit, and the blue LED on the handheld unit will go off. If three beeps are emitted, it indicates unsuccessful pairing between the cradle and the handheld unit, then repeat step 2).



Test barcode:



Example 2: Two handheld units and one cradle

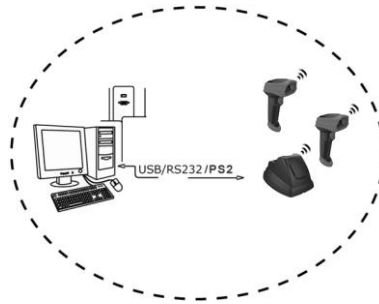

The following takes channel No.5 for instance.

Step 1): Set **Handheld unit RF channel No.** of the first handheld unit to 5.



or



Step 2): Make the first handheld unit scan the following barcode to bind the handheld unit with the cradle.



Firmly position the handheld unit onto the cradle. Within 10 seconds, two beeps will be emitted to signal that the cradle has been paired to the handheld unit, and the blue LED on the handheld unit will go off. If three beeps are emitted, it indicates unsuccessful pairing between the cradle and the handheld unit, then repeat step 2).



Step 3): Make the second handheld unit scan %%JOIN barcode to pair the second handheld unit with the cradle.



Firmly position the handheld unit onto the cradle. Within 10 seconds, two beeps will be emitted to signal that the cradle has been paired to the handheld unit, and the blue LED on the handheld unit will go off. If three beeps are emitted, it indicates unsuccessful pairing between the cradle and the handheld unit, then repeat step 3).



Test barcode:



Example 3: Three handheld units and one cradle

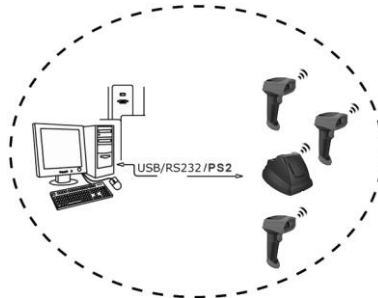

The following takes channel No.5 for instance.

Step 1): Set Handheld unit RF channel No. of the first handheld unit to 5.



or



Step 2): Make the first handheld unit scan the following barcode to bind the handheld unit with the cradle.



Firmly position the handheld unit onto the cradle. Within 10 seconds, two beeps will be emitted to signal that the cradle has been paired to the handheld unit, and the blue LED on the handheld unit will go off. If three beeps are emitted, it indicates unsuccessful pairing between the cradle and the handheld unit, then repeat step 2).

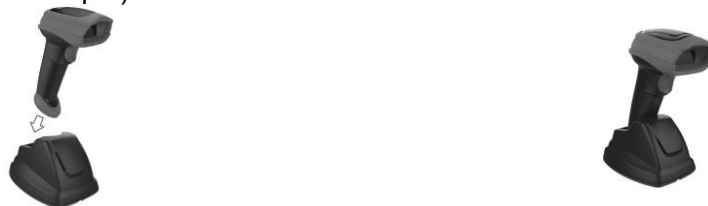

Step 3): Make the second handheld unit scan %%JOIN barcode to pair the second handheld unit with the cradle.



Firmly position the handheld unit onto the cradle. Within 10 seconds, two beeps will be emitted to signal that the cradle has been paired to the handheld unit, and the blue LED on the handheld unit will go off. If three beeps are emitted, it indicates unsuccessful pairing between the cradle and the handheld unit, then repeat step 3).



Step 4): Make the third handheld unit scan %%JOIN barcode to pair the third handheld unit with the cradle.



Firmly position the handheld unit onto the cradle. Within 10 seconds, two beeps will be emitted to signal that the cradle has been paired to the handheld unit, and the blue LED on the handheld unit will go off. If three beeps are emitted, it indicates unsuccessful pairing between the cradle and the handheld unit, then repeat step 4).



Test barcode:



3-3-3 MS352-BT example

The handheld terminal shall ensure that the connection of the base and PC is successful before communicating with the base.

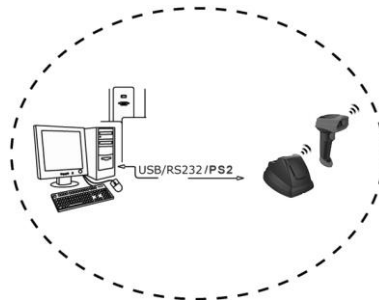

Connect the base:

The handheld terminal scans the connection barcode at the bottom of the base, and the handheld terminal will attempt to connect to the base. If the connection is successful, the handheld terminal will make a beeping sound. If the connection is unsuccessful, the handheld terminal will make a beek-beep sound.



Disconnect:

The handheld terminal scan disconnects the bar code, and the handheld terminal can be disconnected from the base



3-4 Keyboard wedge interface for cradle

Keyboard type: As a keyboard interface, the scanner supports most of the popular PCs and IBM terminals.

Keyboard layout: The scanner supports different national keyboard layouts.

Clock period: According to the PS2 protocol, the clock is provided by the device, e.g. keyboard or scanner, with the period between 60us to 100us.

Delay-after-compound-key: In some rare occasions, machine with low speed PS2 communication port would require a free time gap following the press/release of the compound key (Shift, Ctrl or Alt).

Numeric key:

Alphabetic key- The scanner will output code result as alphabetic key.

Numeric key- The scanner will output code result as pressing numeric keypad ('0', '1', '2', '3', '4', '5', '6', '7', '8', '9', '.', '+', '-', '/', '*' only).

Alt + keypad- The scanner will output code result as pressing Alt+ numeric key (on keypad). Note that the Num Lock control key must be ON. This setting can be specially adapted for use with different national keyboard layout.

Power-on simulation: All of the PCs check the keyboard status during power-on self test. It simulates keyboard timing and passes keyboard present status to the PC during power-on.

Inter-character delay: This delay is inserted after each data character transmitted.

Inter-byte delay: This delay is inserted after each byte transmitted. Normally a character is comprised of three or above bytes.























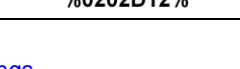

Block trans. delay: It is a delay timer between barcode data output. This feature is used to transfer continually with shorter barcode data.

Caps Lock reversion: By setting enable, the status of Caps Lock key (i.e. being pressed ON or OFF) on the keyboard is simulated in a reversion status.







Caps Lock override: If this function is enabled, on AT or AT notebook hosts, the keyboard ignores the state of the Caps Lock key. Therefore, an 'A' in the bar code is sent as an 'A' no matter what the state of the keyboard's Caps Lock key.

A guide of setting while the scanned data is incorrectly displayed on the host

- ✚ If some characters are missed or some additional characters are incorrectly displayed on the host, set the Inter-byte delay (0208) to be "01" or greater value.
- ✚ If some capital character (e.g. "A") or compound-key-characters (e.g. "shift+", "Ctrl+", "Alt+") are displayed incorrectly, set the Delay-after-compound-key to be "01" or greater value.
- ✚ If some digits are incorrectly displayed as some symbol characters (e.g. "1" and "2" are displayed incorrectly as "!" and "@"), set the Clock period (0203) to be greater value (e.g. 04, 05).

Multiple-scan setting			Single-scan setting
Option bar code	Option	Alpha. entry	
Keyboard type  %0201M%	IBM AT, PS/2	00*	 %0201D00% *
	Apple Mac compatibles	01	 %0201D01%
Keyboard layout  %0202M%	USA	00*	 %0202D00% *
	Turkish F	01	 %0202D01%
	Turkish Q	02	 %0202D02%
	French	03	 %0202D03%
	Italian	04	 %0202D04%
	Spanish	05	 %0202D05%
	Slovak	06	 %0202D06%
	Denmark	07	 %0202D07%
	Japanese	08	 %0202D08%
	German	09	 %0202D09%
	Belgian	10	 %0202D10%
	Russian	11	 %0202D11%
Czech	12	 %0202D12%	
Character encoding system  %0413M%	Refer to 3-7 Handheld scan & some global settings .		
Clock period  %0203M%	60 us	00	 %0203D00%
	70 us	01	 %0203D01%
	80 us	02*	 %0203D02% *
	90 us	03	 %0203D03%
	100 us	04	 %0203D04%

Multiple-scan setting			Single-scan setting
Option bar code	Option	Alpha. entry	
	200 us	05	 %0203D05%
Delay-after-compound-key  %0204M%	0 ms	00*	 %0204D00% *
	10 ms	01	 %0204D01%
	20 ms	02	 %0204D02%
	40 ms	03	 %0204D03%
	80 ms	04	 %0204D04%
Numeric key  %0205M%	Alphabetic key	00*	 %0205D00% *
	Numeric keypad	01	 %0205D01%
	Alt + keypad	02	 %0205D02%
Power-on simulation  %0206M%	Disable	00*	 %0206D00% *
	Enable	01	 %0206D01%
Inter-character delay  %0207M%	0 ms	00*	 %0207D00% *
	5 ms	01	 %0207D01%
	10 ms	02	 %0207D02%
	20 ms	03	 %0207D03%
	40 ms	04	 %0207D04%
	80 ms	05	 %0207D05%
Inter-byte delay  %0208M%	1 ms	00*	 %0208D00% *
	2 ms	01	 %0208D01%
	4 ms	02	 %0208D02%
	8 ms	03	 %0208D03%
Caps Lock reversion	Disable	00*	 %0209D00% *

Multiple-scan setting			Single-scan setting
Option bar code	Option	Alpha. entry	
 %0209M%	Enable	01	 %0209D01%
Caps Lock override  %0210M%	Disable	00*	 %0210D00% *
	Enable	01	 %0210D01%
 %END%			

3-5 RS-232 interface for cradle

Flow control:

None-The communication only uses TxD and RxD signals without any hardware or software handshaking protocol.

















RTS/CTS-If the scanner wants to send the barcode data to host computer, it will issue the RTS signal first, wait for the CTS signal from the host computer, and then perform the normal data communication. If there is no replied CTS signal from the host computer after the timeout duration, the scanner will issue an error indication. By setting (Host idle: Low RTS) or (Host idle: High RTS), the scanner can be set to match the Serial Host RTS line.





















XON/XOFF-An XOFF character turns the scanner transmission off until the scanner receives an XON character.

ACK/NAK-After transmitting data, the scanner expects either an ACK (acknowledge) or NAK (not acknowledge) response from the host. When a NAK is received, the scanner transmits the same data again and waits for either an ACK or NAK. After three unsuccessful attempts to send data when NAKs are received, the scanner issues an error indication and discards the data.

Inter-character delay: Refer to [Inter-character delay](#) of [3-4 Keyboard wedge for cradle](#).

Response delay: This delay is used for serial communication of the scanner when it waits for a handshaking acknowledgment from the host.

Multiple-scan setting			Single-scan setting
Option bar code	Option	Alpha. entry	
Flow control  %0301M%	None	00*	 %0301D00% *
	RTS/CTS (Host idle: Low RTS)	01	 %0301D01%
	RTS/CTS (Host idle: High RTS)	02	 %0301D02%
	XON/XOFF	03	 %0301D03%
	ACK/NAK	04	 %0301D04%
Inter-character delay  %0302M%	0 ms	00*	 %0302D00% *
	5 ms	01	 %0302D01%
	10 ms	02	 %0302D02%
	20 ms	03	 %0302D03%
	40 ms	04	 %0302D04%
	80 ms	05	 %0302D05%
Response delay  %0304M%	00-99 (100 ms)	00-99	
		00*	 %0304D00% *
Baud rate	300	00	 %0305D00%

Multiple-scan setting			Single-scan setting
Option bar code	Option	Alpha. entry	
 %0305M%	600	01	 %0305D01%
	1200	02	 %0305D02%
	2400	03	 %0305D03%
	4800	04	 %0305D04%
	9600	05*	 %0305D05% *
	19200	06	 %0305D06%
	38400	07	 %0305D07%
	57600	08	 %0305D08%
	115200	09	 %0305D09%
Parity  %0306M%	None	00*	 %0306D00% *
	Odd	01	 %0306D01%
	Even	02	 %0306D02%
Data bit  %0307M%	8 bits	00*	 %0307D00% *
	7 bits	01	 %0307D01%
Stop bit  %0308M%	1 bit	00*	 %0308D00% *
	2 bits	01	 %0308D01%
 %END%			

3-6 USB interface for cradle

USB device type:

HID keyboard– By setting, the scanner is used as a USB HID keyboard emulation device. The keyboard layout setting follows the setting of `keyboard layout` in [3-4 Keyboard wedge for cradle](#).

USB virtual COM– By setting, the scanner emulate a regular RS232-based COM port. If a Microsoft Windows PC is connected to the scanner, a driver is required to install on the connected PC. The driver will use the next available COM Port number. The driver and the installation guide can be found in the associated CD and on the manufacturer's website. A Windows-based software COM_Text is recommended to display the barcode data in text format. COM_Text emulates some kind of serial-key typing.

Note: When changing USB Device Type, the scanner automatically restarts.

Simple COM Port Emulation- Please contact the manufacturer for the instruction.

Keyboard layout: The scanner supports different national keyboard layouts.

















Inter-character delay: This delay is inserted after each data character transmitted. By selecting, the user can change the output speed of the scanner to match the speed of the host USB communication port.





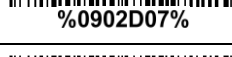



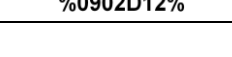



Numeric key:

Alphabetic key- The scanner will output code result as alphabetic key.

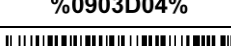
Numeric key- The scanner will output code result as pressing numeric keypad ('0', '1', '2', '3', '4', '5', '6', '7', '8', '9', ':', '+', '-', '/', '*' only).

Alt + keypad- The scanner will output code result as pressing Alt+ numeric key (on keypad). Note that the Num Lock control key must be ON. This setting can be specially adapted for use with different national keyboard layout.

Multiple-scan setting			Single-scan setting
Option bar code	Option	Alpha. entry	
USB device type  %0901M%	HID keyboard	00*	 %0901D00% *
	HID keyboard for Apple Mac	01	 %0901D01%
	USB virtual COM	02	 %0901D02%
	Simple COM Port Emulation	03	 %0901D03%
Keyboard layout  %0902M%	USA	00*	 %0902D00% *
	Turkish F	01	 %0902D01%
	Turkish Q	02	 %0902D02%
	French	03	 %0902D03%
	Italian	04	 %0902D04%
	Spanish	05	 %0902D05%
	Slovak	06	 %0902D06%
	Denmark	07	 %0902D07%
	Japanese	08	 %0902D08%
	German	09	 %0902D09%
	Belgian	10	 %0902D10%
	Russian	11	 %0902D11%
Czech	12	 %0902D12%	

Multiple-scan setting			Single-scan setting
Option bar code	Option	Alpha. entry	
Character encoding system  %0413M%	Refer to 3-7 Handheld scan & some global settings.		
Inter-character delay  %0903M%	0 ms	00	 %0903D00%
	5 ms	01*	 %0903D01% *
	10 ms	02	 %0903D02%
	20 ms	03	 %0903D03%
	40 ms	04	 %0903D04%
	60 ms	05	 %0903D05%
Numeric key  %0904M%	Alphabetic key	00*	 %0904D00% *
	Numeric keypad	01	 %0904D01%
	Alt + keypad	02	 %0904D02%
 %END%			

3-7 Handheld scan & some global settings

Scanning mode:

Good-read off-The trigger button must be pressed once to activate scanning. The scanner will stop scanning when there is a successful reading or no code is decoded after the **Stand-by duration** elapsed.

Momentary-The trigger button acts as a switch. Press button to activate scanning and release button to stop scanning. The scanner will stop scanning when there is a successful reading or no code is decoded after the **Stand-by duration** elapsed.

Alternate continue-The trigger button acts as a toggle switch. Press button to activate or stop scanning.

Continue-The scanner always keeps scanning, and it does not matter when the trigger button is pressed or duration is elapsed.

Timeout off-The trigger button must be pressed once to activate scanning. The scanner will stop scanning when no code is successful decoded after the **Stand-by duration** elapsed.

Auto-detection- Good-read off – By setting Enable, the scanner will start operating if any nearby object has been detected. The scanner will stop scanning when there is a successful reading or no code is decoded after the **Stand-by duration** elapsed. Once the scanner stops scanning, the present object must be removed to enable **Auto-detection**.

Auto-detection- Good-read on – By setting Enable, the scanner will start operating if any nearby object has been detected. The scanner stops scanning when no code is successful decoded after the **Stand-by duration** elapsed. Once the scanner stops scanning, the present object must be removed to enable **Auto-detection**.

Auto-detection sensitivity: It is the sensitivity of scanner to ambient brightness change. Sensitivity is expressed as a percentage value of ambient light change, in the range of 5% to 50%. The smaller the percentage value, the higher the sensitivity, the easier the scanner will be triggered

Same barcode delay time: If a barcode has been scanned and output once successfully, the scan operation should be interrupted for delay time or the focus of the scanner must be moved away from the barcode beyond delay time to active scanning the same barcode. When this feature is set to be "0xFF", then the delay time is indefinite.

Double confirm: If it is enabled, the scanner will require a several times of same-decoded-data to confirm a valid reading.

Global Max./Min. code length for 1D symbol: These two lengths are defined as the valid range of decoded 1D barcode data length. Make sure that the minimum length setting is no greater than the maximum length setting, or otherwise the labels of the symbol will not be readable. In particular, the same value can be set for both minimum and maximum reading length to force the fixed length barcode decoded.

Same barcode delay time for 2D symbol: If a 2D barcode has been scanned and output once successfully, the scanner must output the same barcode data beyond delay time. When this feature is set to be "0xFF", then the delay time is indefinite.

Notes:

1. Please set the max./min. length for individual barcode in later sections, if special demand is requested.
2. The number of check digits is included in max./min. code length.
3. These two settings have no effect on the symbols with fixed-length, e.g. UPC-A, UPC-E, EAN-13, EAN-8 and China Post.

Global G1-G6 string selection: The scanner offer one or two string group for ALL symbols. By setting one or two digits to indicate which string group you want to apply. You may refer to [3-40 G1-G6 & C1-C2 & FN1 substitution string setting](#) and [3-41 G1-G4 string position & Code ID position](#).

Example: Group 1 → set 01 or 10. Group 2 and 4 → set 24 or 42.

All valid settings include 00, 01, 02, 03, 04, 05, 06, 10, 11, 12, 13, 14, 15, 16, 20, 21, 22, 23, 24, 25, 26, 30, 31, 32, 33, 34, 35, 36, 40, 41, 42, 43, 44, 45, 46, 50, 51, 52, 53, 54, 55, 56, 60, 61, 62, 63, 64, 65 and 66.

Element amendment: If it is enabled, the scanner can read the barcode comprised with bars and spaces in different scale.

Character output restraint:

Printable character only- If this option is selected, the scanner will output the printable characters only, i.e. in ASCII from 20H to 7EH.

























Alphanumeric character only- If this option is selected, the scanner will output the alphanumeric characters only, i.e. "A"- "Z", "a"- "z", "0"- "9".





















Decoder optimization: If it is enabled, the scanner will optimize the decoder with error correction. This function is not effective for all types of barcodes.

























Data output delay in continue-scan mode: If it is enabled, in the continue-scan mode, the scanner can store the data while continue-scanning. The scanner will output the data after the predefined delay elapsed. The maximum storage of data is 1000 characters. If this parameter is set to be "00", the scanner will not store data. And if the parameter is set to be "FF", the scanner will output data after stopping scanning.

Character encoding system: A character encoding system consists of a code that pairs each character from a given repertoire. Common examples include Morse code, the Baudot code, the ASCII and Unicode. If the data received does not display with the proper characters (e.g. domestic language), it maybe because the barcode being scanned was created using a character encoding system that is different from the one the host program is expecting. Try alternate options to find the proper one.

Complete data output before next decode attempt: This setting is active only when USB device type is set as "HID keyboard" or "HID keyboard for Apple Mac", refer to [3-6 USB interface for cradle](#). If it is enabled, the imager will not start next decode attempt until previous data output is completed.

Multiple-scan setting			Single-scan setting
Option barcode	Option	Alpha. entry	
Scan mode  %0401M%	Good-read off	00	 %0401D00%
	Momentary	01*	 %0401D01% *
	Alternate continue	02	 %0401D02%
	Continue	03	 %0401D03%
	Good-read on	04	 %0401D04%
	Auto-detection- Good-read on	06	 %0401D06%
	Auto-detection- Good-read off	07	 %0401D07%
Auto-detection sensitivity  %0604M%	5%*	00*	 %0604D00% *
	10%	01	 %0604D01%
	15%	02	 %0604D02%
	20%	03	 %0604D03%
	25%	04	 %0604D04%
	30%	05	 %0604D05%
	35%	06	 %0604D06%
	40%	07	 %0604D07%
	45%	08	 %0604D08%
	50%	09	 %0604D09%
Standby duration  %0402M%	4 seconds	00*	 %0402D00% *
	8 seconds	01	 %0402D01%
	16 seconds	02	 %0402D02%
	24 seconds	03	 %0402D03%
	30 seconds	04	 %0402D04%

Multiple-scan setting			Single-scan setting
Option barcode	Option	Alpha. entry	
	1 minute	05	 %0402D05%
	1.5 minutes	06	 %0402D06%
	2 minutes	07	 %0402D07%
	5 minutes	08	 %0402D08%
	7 minutes	09	 %0402D09%
	10 minutes	10	 %0402D10%
	15 minutes	11	 %0402D11%
	20 minutes	12	 %0402D12%
	30 minutes	13	 %0402D13%
	45 minutes	14	 %0402D14%
	1 hour	15	 %0402D15%
Same barcode delay time for 1D symbol  %0403M%	00-FF ₁₆ (50 ms)	00-FF ₁₆	
		00	 %0403H00%
		08*	 %0403H08% *
Same barcode delay time for 2D symbol  %0415M%	00-FF ₁₆ (50 ms)	00-FF ₁₆	
		00	 %0415H00%
		08*	 %0415H08% *
Double confirm  %0404M%	00-09 (00: none)	00-09	
		00*	 %0404D00% *
Global max. code length for 1D symbol  %0405M%	04-99	04-99	
		99*	 %0405D99% *
Global min. code length for 1D symbol	01-99	01-99	

Multiple-scan setting			Single-scan setting
Option barcode	Option	Alpha. entry	
 %0406M%		04*	 %0406D04% *
Global G1-G6 string selection  %0407M%	00-66 (00: none)	00-66	
		00*	 %0407D00% *
Element amendment  %0408M%	Disable	00	 %0408D00%
	Enable	01*	 %0408D01% *
Character output restraint  %0409M%	None	00*	 %0409D00% *
	Printable character only	01	 %0409D01%
	Alphanumeric character only	02	 %0409D02%
Decoder optimization  %0410M%	Disable	00	 %0410D00%
	Enable	01*	 %0410D01% *
Data output delay in continue-scan mode  %0411M%	00-99 (100 ms) FF (Never)	00-FF ₁₆	
		00*	 %0411H00% *
Character encoding system  %0413M%	ASCII	00*	 %0413D00% *
	UTF-8	01	 %0413D01%
	Windows-1251	02	 %0413D02%
Complete data output before next decode attempt  %0414M%	Disable	00*	 %0414D00% *
	Enable	01	 %0414D01%
 %END%			

3-8 Indication for handheld unit

Power on alert: After power-on the scanner will generate an alert signal to indicate a successful self-test.



















LED indication: After each successful reading, the LED above the scanner will light up to indicate a good barcode reading.

Beeper indication: After each successful reading, the scanner will beep to indicate a good barcode reading, and its beep tone duration is adjustable.

Beep tone duration: This parameter can be adjusted for a good reading upon favorite usage.

Volume of beeper: This parameter can be adjusted for different level of the volume of the beeper.

Vibrator indication: After each successful reading, the vibrator will vibrate to indicate a good barcode reading.

Multiple-scan setting			Single-scan setting
Option bar code	Option	Alpha. entry	
Power on alert  %0501M%	Disable	00	 %0501D00%
	Enable	01*	 %0501D01% *
LED indication  %0502M%	Disable	00	 %0502D00%
	Enable	01*	 %0502D01% *
Beeper indication  %0503M%	Disable	00	 %0503D00%
	Enable	01*	 %0503D01%
Beep tone duration  %0504M%	01-09 (10 ms)	01-09	
		05*	 %0504D05% *
Volume of beeper  %0505M%	Low	00	 %0505D00%
	Middle	01	 %0505D01%
	High	02*	 %0505D02% *
Vibrator indication  %0507M%	Disable	00	 %0507D00%
	Enable	01*	 %0506D01% *



3-9 Decode illumination and decode aiming pattern

Decode illumination mode: Enable illumination causes the scanner to turn on the illumination to aid decoding. Disable illumination to turn off illumination for the scanner during decoding. Better quality images could be obtained with illumination support. The effectiveness of the illumination decreases as the distance to the target increases.

Decode aiming pattern: When this option is enabled, the scanner will project the aiming pattern during the code capture.

Level of decode illumination: This parameter can be adjusted for different level of decode illumination.



















Illumination mode of Auto-detection:

Always off- Illumination LED will be always turned off.

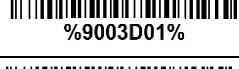
Enable illumination in low light conditions- In low light conditions, the scanner will turn on illumination LED automatically to ensure normal work. While in other light conditions, the illumination LED will be turned off automatically.

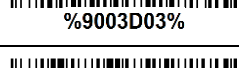
Always on- Illumination LED will be always turned on (Default).

Note: This function is only valid in Auto-detection mode.

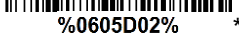













Multiple-scan setting			Single-scan setting
Option bar code	Option	Alpha. Entry	
Decode illumination  %9001M%	Always Off	00	 %9001D00%
	Always On	01	 %9001D01%
	Flashing	02*	 %9001D02% *
	On when reading	03	 %9001D03%
Decode aiming pattern  %9002M%	Always Off	00	 %9002D00%
	Always On	01	 %9002D01%
	On before reading	02	 %9002D02%
	On when reading	03*	 %9002D03% *
Level of decode illumination  %9003M%	Disable decode illumination	00	 %9003D00%
	Low	01	 %9003D01%
	Middle	02*	 %9003D02% *
	High	03	 %9003D03%
Illumination mode of Auto-detection  %0605M%	Always off	00	 %0605D00%
	Enable illumination in low light conditions	01	 %0605D01%
	Always on	02*	 %0605D02% *

 %END%

3-10 Single type of barcode read

1D symbols read: A global setting of 1D symbols readability.

2D symbols read: A global setting of 2D symbols readability.

Multiple-scan setting			Single-scan setting
Option barcode	Option	Alpha. entry	
1D symbols read  %1005M%	Follow respective 1D symbol setting	00*	 %1005D00% *
	All 1D Disable	01	 %1005D01%
	All 1D Enable	02	 %1005D02%
2D symbols read  %1001M%	Follow respective 2D symbol setting	00*	 %1001D00% *
	All 2D Disable	01	 %1001D01%
	All 2D Enable	02	 %1001D02%
	Only PDF417 Enable	03	 %1001D03%
	Only QR code Enable	04	 %1001D04%
	Only Data Matrix Enable	05	 %1001D05%
	Only MaxiCode Enable	06	 %1001D06%
	Only Aztec Code Enable	07	 %1001D07%
	Only Han Xin Code Enable	08	 %1001D08%
 %END%			

3-11 DPM, Multiple symbols, Structured append read, etc.

DPM format read: By setting Enable, the scanner can read 2D symbols in DPM (Direct Park Marking) format. Some barcodes in DPM format are shown below.

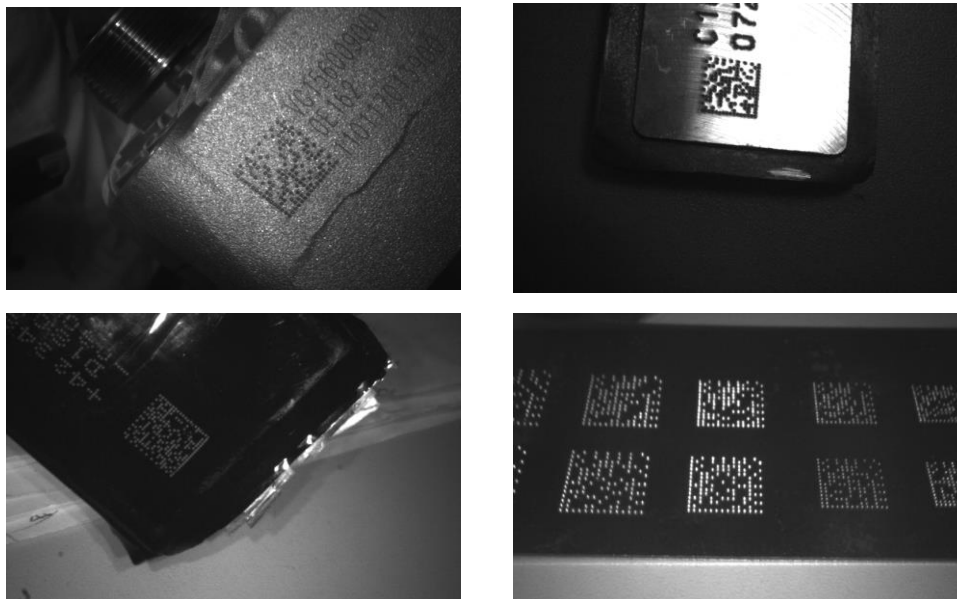





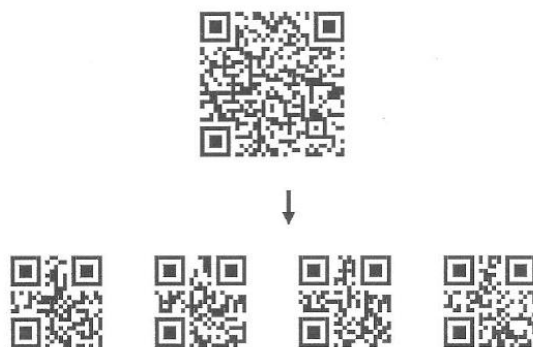





Multiple symbols & structured append symbols read:

- 1) By setting Enable, the scanner allows to read multiple symbols with a single pull of the scanner's trigger. If the user pulls and holds the trigger, aiming the scanner at a series of symbols, it reads unique symbols once, beeping for each success read. The scanner attempts to find and decode new symbols as long as the trigger is pulled.
- 2) By setting Enable, the scanner will output data only when all Structured Append symbols have been decoded. The lower part of below figure shows an example of four Structured Append symbols, with the same data as that in the upper symbol.
- 3) By setting Disable, the scanner will only read the symbol closest to the aiming beam.



Single symbol (above) and Structured Append series of symbols (below) encoding
"ABCDEFGHIJKLMNOPQRSTUVWXYZ0123456789ABCDEFGHIJKLMNOPQRSTUVWXYZ"

Mobile screen read: By setting enable, the scanner can read barcodes on a mobile screen better. However, this will slow the reading speed of normal barcodes a little bit, and the decode illumination will flash.

Multiple-scan setting			Single-scan setting
Option bar code	Option	Alpha. entry	
DPM format read  %1002M%	Disable	00*	 %1002D00% *
	Enable	01	 %1002D01%
structured append symbols read  %1006M%	Disable	00*	 %1006D00%
	Enable	01	 %1006D01% *
Mobile screen read  %1007M%	Disable	00*	 %1007D00% *
	Enable	01	 %1007D01%
 %END%			

3-12 UPC-A

Read:
Format

System character	Data digits (10 digits)	Check digit
------------------	-------------------------	-------------

Check digit verification: The check digit is optional.

Check digit trans.: By setting Enable, check digit will be transmitted.

Code ID setting: Code ID is a one-or-two-character string used to represent the symbol upon a succeeding reading. If you want application to transmit Code ID, you must set [Code ID transmission](#) to be enabled, refer to [3-42 String transmission](#).

Insertion group selection: Refer to [Global insertion group selection](#) of [3-7 Handheld scan & some global settings](#).

Supplement digits: The Supplement digits barcode is the supplemental 2 or 5 characters.

Format

System character	Data digits (10 digits)	Check digit	Supplement digits 2 or 5
------------------	-------------------------	-------------	--------------------------

















Truncation/Expansion:

Truncate leading zeros- The leading “0” digits of UPC-A data characters can be truncated when the feature is enabled.

Expand to EAN-13- It extends to 13-digits with a “0” leading digit when the feature is enabled.

Truncate system character- The system character of UPC-A data can be truncated when the feature is enabled.

Add country code- The country code (“0” for USA) can be added when the feature is enabled.

Multiple-scan setting			Single-scan setting
Option barcode	Option	Alpha. entry	
Read  %1101M%	Disable	00	 %1101D00%
	Enable	01*	 %1101D01% *
Check digit verification  %1102M%	Disable	00	 %1102D00%
	Enable	01*	 %1102D01% *
Check digit trans.  %1103M%	Disable	00	 %1103D00%
	Enable	01*	 %1103D01% *
Code ID setting  %1104M%	00-FF ₁₆ (ASCII)	00-FF ₁₆	
		<A>*	 %1104H41% *
Insert group selection  %1105M%	00-66	00-66	
		00*	 %1105D00%
Supplement digits  %1106M%	None	00*	 %1106D00% *
	2 digits	01	 %1106D01%
	5 digits	02	 %1106D02%
	2 or 5 digits	03	 %1106D03%
Truncation/Expansion  %1107M%	None	00*	 %1107D00% *
	Truncate leading zeros	01	 %1107D01%
	Expand to EAN-13	02	 %1107D02%
	Truncate system character	03	 %1107D03%
	Add country code	04	 %1107D04%



3-13 UPC-E

Read:

Format

System character "0"	Data digits (6 digits)	Check digit
----------------------	------------------------	-------------

Check digit verification: The check digit is optional and made as the sum of the numerical value of the data digits.

Check digit trans.: By setting Enable, check digit will be transmitted.

Code ID setting: Refer to [Code ID setting](#) of [3-12 UPC-A](#).

Insertion group selection: Refer to [Insertion group selection](#) of [3-12 UPC-A](#).

Supplement digits:

Format

System character "0"	Data digits (6 digits)	Check digit	Supplement digits 2 or 5
----------------------	------------------------	-------------	--------------------------

Truncation/Expansion:

Truncate leading zeros- Refer to [Truncation/Expansion](#) of [3-12 UPC-A](#).

























Expand to EAN-13- It extends to 13-digits with "0" digits when the feature is set to be enabled.

Example: Barcode "0123654",

Output: "0012360000057".

Expand to UPC-A- It extends to 12-digits when the feature is set to be enabled.

Truncate system character- The system character "0" of UPC-E data can be truncated when the feature is enabled.

Multiple-scan setting			Single-scan setting
Option barcode	Option	Alpha. entry	
Read  %1201M%	Disable	00	 %1201D00%
	Enable	01*	 %1201D01% *
Check digit verification  %1202M%	Disable	00	 %1202D00%
	Enable	01*	 %1202D01% *
Check digit trans.  %1203M%	Disable	00	 %1203D00%
	Enable	01*	 %1203D01% *
Code ID setting  %1204M%	00-FF ₁₆ (ASCII)	00-FF ₁₆	
		<D>*	 %1204H44% *
Insert group selection  %1205M%	00-66	00-66	
		00*	 %1205D00% *
Supplement digits  %1206M%	None	00*	 %1206D00% *
	2 digits	01	 %1206D01%
	5 digits	02	 %1206D02%
	2 or 5 digits	03	 %1206D03%
Truncation/Expansion  %1207M%	None	00*	 %1207D00% *
	Truncate leading zeros	01	 %1207D01%
	Expand to EAN-13	02	 %1207D02%
	Expand to UPC-A	03	 %1207D03%
	Truncate system character	04	 %1207D04%



3-14 UPC-E1

Read:

Format

System character "1"	Data digits (5 digits)	Check digit
----------------------	------------------------	-------------

Check digit verification: The check digit is optional and made as the sum of the numerical value of the data digits.

Check digit trans.: By setting **Enable**, check digit will be transmitted.

Code ID setting: Refer to **Code ID setting** of [3-12 UPC-A](#).

Insertion group selection: Refer to **Insertion group selection** of [3-12 UPC-A](#).

Supplement digits:

Format























System character "1"	Data digits (5 digits)	Check digit	Supplement digits 2 or 5
----------------------	------------------------	-------------	--------------------------

Truncation/Expansion:

Expand to EAN-13- It extends to 13-digits with "0" digits when the feature is set to be enabled.

Expand to UPC-A- It extends to 12-digits when the feature is set to be enabled.

Truncate system character- The system character "1" of UPC-E1 data can be truncated when the feature is enabled.

Multiple-scan setting			Single-scan setting
Option barcode	Option	Alpha. entry	
Read  %3401M%	Disable	00	 %3401D00%
	Enable	01*	 %3401D01% *
Check digit verification  %3402M%	Disable	00	 %3402D00%
	Enable	01*	 %3402D01% *
Check digit trans.  %3403M%	Disable	00	 %3403D00%
	Enable	01*	 %3403D01% *
Code ID setting  %3404M%	00-FF ₁₆ (ASCII)	00-FF ₁₆	
		<D>*	 %3404H44% *
Insert group selection  %3405M%	00-66	00-66	
		00*	 %3405D00% *
Supplement digits  %3406M%	None	00*	 %3406D00% *
	2 digits	01	 %3406D01%
	5 digits	02	 %3406D02%
	2 or 5 digits	03	 %3406D03%
Truncation/Expansion  %3407M%	None	00*	 %3407D00% *
	Expand to EAN-13	02	 %3407D02%
	Expand to UPC-A	03	 %3407D03%
	Truncate system character	04	 %3407D04%



3-15 EAN-13 (ISBN/ISSN)

Read:

Format

Data digits (12 digits)	Check digit
-------------------------	-------------

Check digit verification: The check digit is optional and made as the sum of the numerical value of the data digits.

Check digit transmission: By setting Enable, check digit will be transmitted.

EAN-13 code ID setting: Refer to [Code ID setting](#) of [3-12 UPC-A](#).

Insertion group selection: Refer to [Insertion group selection](#) of [3-12 UPC-A](#).

Supplement digits:

Format

Data digits (12 digits)	Check digit	Supplement digits 2 or 5
-------------------------	-------------	--------------------------









ISBN/ISSN conversion: The ISBN (International Standard Book Number, or Bookland EAN) and ISSN (International Standard Serial Number) are two kinds of barcode for books and magazines. The ISBN is 10 digits with leading “978” and the ISSN is 8 digits with leading “977” of the EAN-13 symbol.

Example:

Barcode “9780194315104”, Output: “019431510X”.

Barcode “9771005180004”, Output: “10051805”.

ISBN/ISSN code ID setting: Refer to [Code ID setting](#) of [3-12 UPC-A](#).

Multiple-scan setting			Single-scan setting
Option barcode	Option	Alpha. entry	
Read  %1301M%	Disable	00	 %1301D00%
	Enable	01*	 %1301D01% *
Check digit verification  %1302M%	Disable	00	 %1302D00%
	Enable	01*	 %1302D01% *
Check digit transmission  %1303M%	Disable	00	 %1303D00%
	Enable	01*	 %1303D01% *
EAN-13 code ID setting  %1304M%	00-FF ₁₆ (ASCII)	00-FF ₁₆	
		<A>*	 %1304H41% *
Insert group selection  %1305M%	00-66	00-66	
		00*	 %1305D00% *
Supplement digits  %1306M%	None	00*	 %1306D00% *
	2 digits	01	 %1306D01%
	5 digits	02	 %1306D02%
	2 or 5 digits	03	 %1306D03%
ISBN/ISSN conversion  %1307M%	Disable	00*	 %1307D00% *
	Enable	01	 %1307D01%
ISBN/ISSN code ID setting  %1309M%	00-FF ₁₆ (ASCII)	00-FF ₁₆	
		*	 %1309H42% *
 %END%			

3-16 EAN-8

Read:

Format

Data digits (7 digits)	Check digit
------------------------	-------------

Check digit verification: The check digit is optional and made as the sum of the numerical value of the data digits.

Check digit trans.: By setting `Enable`, check digit will be transmitted.

Code ID setting: Refer to `Code ID setting` of [3-12 UPC-A](#).

Insertion group selection: Refer to `Insertion group selection` of [3-12 UPC-A](#).

Supplement digits:

Format

Data digits (7 digits)	Check digit	Supplement Digits 2 or 5
------------------------	-------------	--------------------------

Truncation/Expansion: Refer to `Truncation/Expansion` of [3-12 UPC-A](#).

Multiple-scan setting			Single-scan setting
Option barcode	Option	Alpha. entry	
Read  %1401M%	Disable	00	 %1401D00%
	Enable	01*	 %1401D01% *
Check digit verification  %1402M%	Disable	00	 %1402D00%
	Enable	01*	 %1402D01% *
Check digit trans.  %1403M%	Disable	00	 %1403D00%
	Enable	01*	 %1403D01% *
Code ID setting  %1404M%	00-FF ₁₆ (ASCII)	00-FF ₁₆	
		<C>*	 %1404H42% *
Insert group selection  %1405M%	00-66	00-66	
		00*	 %1405D00% *
Supplement digits  %1406M%	None	00*	 %1406D00% *
	2 digits	01	 %1406D01%
	5 digits	02	 %1406D02%
	2 or 5 digits	03	 %1406D03%
Truncation/Expansion  %1407M%	None	00*	 %1407D00% *
	Truncate leading zero	01	 %1407D01%
	Expand to EAN-13	02	 %1407D02%



3-17 Code 39 (Code 32, Trioptic Code 39)

Read:

Format

*	Data digits (variable)	Check digit (optional)	*
---	------------------------	------------------------	---

Check digit verification: The check digit is optional and made as the sum module 43 of the numerical value of the data digits.

Check digit transmission: By setting Enable, check digit will be transmitted.

Max./Min. code length: Each symbol has own max./min. code length. If both setting of max./min. code length are "00"s, the setting of global max./min. code length is effective. The length is defined as to the actual barcode data length to be sent. Label with length exceeds these limits will be rejected. Make sure that the minimum length setting is no greater than the maximum length setting, or otherwise all the labels of the symbol will not be readable. In particular, you can see the same value for both minimum and maximum reading length to force the fixed length barcode decoded.

Code ID setting: Refer to [Code ID setting](#) of [3-12 UPC-A](#).

Insertion group selection: Refer to [Insertion group selection](#) of [3-12 UPC-A](#).

Start/End transmission: The start and end characters of Code 39 are "*" s. You can transmit all data digits including two "*" s.

"*" **as data character:** By setting Enable, "*" can be recognized as data character.

Convert Code 39 to Code 32: Code 32 is a variant of Code 39 used by the Italian pharmaceutical industry. Note that Code 39 must be enabled in order for this parameter to function.

Format of Code 32

"A" (optional)	Data digits (8 digits)	Check digit
----------------	------------------------	-------------





























Code 32 Prefix "A" transmission: By setting Enable, the prefix character "A" can be added to all Code 32 barcodes.









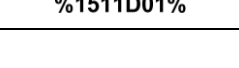

Trioptic Code 39 read: Trioptic Code 39 is a variant of Code 39 used in the marking of magnetic tapes and computer cartridges. Trioptic Code 39 symbols always contain six characters.

Format

\$	Data digits (6 digits)	\$
----	------------------------	----

Trioptic Code 39 Start/End transmission: The start and end characters of Trioptic Code 39 are "\$" s. You can transmit all data digits including two "\$" s.

Multiple-scan setting			Single-scan setting
Option bar code	Option	Alpha. entry	
Read  %1501M%	Disable	00	 %1501D00%
	Enable	01*	 %1501D01% *
Check digit verification  %1502M%	Disable	00*	 %1502D00% *
	Enable	01	 %1502D01%
Check digit transmission  %1503M%	Disable	00*	 %1503D00% *
	Enable	01	 %1503D01%
Max. code length  %1504M%	00-99	00-99	
		00*	 %1504D00% *
Min. code length  %1505M%	00-99	00-99	
		01*	 %1505D01% *
Code ID setting  %1506M%	00-FF ₁₆ (ASCII)	00-FF ₁₆	
		<M>*	 %1506H4D% *
Insert group selection  %1507M%	00-66	00-66	
		00*	 %1507D00% *
Format  %1508M%	Standard	00*	 %1508D00% *
	Full ASCII	01	 %1508D01%
Start/End transmission  %1509M%	Disable	00*	 %1509D00% *
	Enable	01	 %1509D01%
“*” as data character  %1510M%	Disable	00*	 %1510D00% *
	Enable	01	 %1510D01%
Convert Code 39 to Code 32  %1511M%	Disable	00*	 %1511D00% *
	Enable	01	 %1511D01%

Multiple-scan setting			Single-scan setting
Option bar code	Option	Alpha. entry	
Code 32 Prefix "A" transmission  %1512M%	Disable	00*	 %1512D00% *
	Enable	01	 %1512D01%
Trioptic Code 39 read  %1513M%	Disable	00*	 %1513D00% *
	Enable	01	 %1513D01%
Trioptic Code 39 Start/End transmission  %1514M%	Disable	00*	 %1514D00% *
	Enable	01	 %1514D01%
 %END%			

3-18 Interleaved 2 of 5

Read:

Format

Data digits (Variable)	Check digit (optional)
------------------------	------------------------

Check digit verification: The check digit is made as the sum module 10 of the numerical values of all data digits. There are two optional check digit algorithms: the specified Uniform Symbol Specification (USS) and the Optical Product Code Council (OPCC).

Check digit transmission: By setting Enable, check digit will be transmitted.

Max./Min. code length: Refer to [Max./Min. code length](#) of [3-17 Code 39](#).

Code ID setting: Refer to [Code ID setting](#) of [3-12 UPC-A](#).

Insertion group selection: Refer to [Insertion group selection](#) of [3-12 UPC-A](#).

Multiple-scan setting			Single-scan setting
Option bar code	Option	Alpha. entry	
Read  %1601M%	Disable	00	 %1601D00%
	Enable	01*	 %1601D01% *
Check digit verification  %1602M%	Disable	00*	 %1602D00% *
	USS	01	 %1602D01%
	OPCC	02	 %1602D02%
Check digit transmission  %1603M%	Disable	00*	 %1603D00% *
	Enable	01	 %1603D01%
Max. code length  %1604M%	00-99	00-99	
		00*	 %1604D00% *
Min. code length  %1605M%	00-99	00-99	
		06*	 %1605D06% *
Code ID setting  %1606M%	00-FF ₁₆ (ASCII)	00-FF ₁₆	
		<I>*	 %1606H49% *
Insert group selection  %1607M%	00-66	00-66	
		00*	 %1607D00% *



3-19 Industrial 2 of 5









Read:
Format

Data digits (variable)

Max./Min. code length: Refer to Max./Min. code length of 3-17 Code 39.

Code ID setting: Refer to Code ID setting of 3-12 UPC-A.

Insertion group selection: Refer to Insertion group selection of 3-12 UPC-A.

Multiple-scan setting			Single-scan setting
Option bar code	Option	Alpha. entry	
Read  %1701M%	Disable	00*	 %1701D00% *
	Enable	01	 %1701D01%
Max. code length  %1702M%	00-99	00-99	
		00*	 %1702D00% *
Min. code length  %1703M%	00-99	00-99	
		00*	 %1703D00% *
Code ID setting  %1704M%	00-FF ₁₆ (ASCII)	00-FF ₁₆	
		<H>*	 %1704H48% *
Insert group selection  %1705M%	00-66	00-66	
		00*	 %1705D00% *
 %END%			

3-20 Matrix 2 of 5

Read:
Format

Data digits (variable)	Check digit (optional)
------------------------	------------------------



















Check digit verification: The check digit is made as the sum module 10 of the numerical values of all data digits.

Check digit transmission: By setting Enable, check digit will be transmitted.

Max./Min. code length: Refer to [Max./Min. code length](#) of 3-17 Code 39.

Code ID setting: Refer to [Code ID setting](#) of 3-12 UPC-A.

Insertion group selection: Refer to [Insertion group selection](#) of 3-12 UPC-A.

Multiple-scan setting			Single-scan setting
Option bar code	Option	Alpha. entry	
Read  %1801M%	Disable	00	 %1801D00%
	Enable	01*	 %1801D01% *
Check digit verification  %1802M%	Disable	00*	 %1802D00% *
	Enable	01	 %1802D01%
Check digit transmission  %1803M%	Disable	00*	 %1803D00% *
	Enable	01	 %1803D01%
Max. code length  %1804M%	00-99	00-99	
		00*	 %1804D00% *
Min. code length  %1805M%	00-99	00-99	
		06*	 %1805D06% *
Code ID setting  %1806M%	00-FF ₁₆ (ASCII)	00-FF ₁₆	
		<X>*	 %1806H58% *
Insert group selection  %1807M%	00-66	00-66	
		00*	 %1807D00% *
 %END%			

3-21 Codabar

Read:
Format

Start character	Data digits (variable)	Check digit (optional)	End character
-----------------	------------------------	------------------------	---------------

Check digit verification: The check digit is made as the sum module 16 of the numerical values of all

data digits.

Check digit transmission: By setting Enable, check digit will be transmitted.

Max./Min. code length: Refer to [Max./Min. code length](#) of [3-17 Code 39](#).





















Code ID setting: Refer to [Code ID setting](#) of [3-12 UPC-A](#).





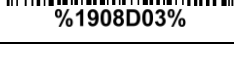

Insertion group selection: Refer to [Insertion group selection](#) of [3-12 UPC-A](#).

Start/End type: Codabar has four pairs of Start/End pattern; you may select one pair to match your application.

Start/End transmission: Refer to [Start/End transmission](#) of [3-17 Code 39](#).

Start/End character equality: By setting Enable, the start and end character of a Codabar barcode must be the same.

Multiple-scan setting			Single-scan setting
Option bar code	Option	Alpha. entry	
Read  %1901M%	Disable	00	 %1901D00%
	Enable	01*	 %1901D01% *
Check digit verification  %1902M%	Disable	00*	 %1902D00% *
	Enable	01	 %1902D01%
Check digit transmission  %1903M%	Disable	00*	 %1903D00% *
	Enable	01	 %1903D01%
Max. code length  %1904M%	00-99	00-99	
		00*	 %1904D00% *
Min. code length  %1905M%	00-99	00-99	
		00*	 %1905D00% *
Code ID setting  %1906M%	00-FF ₁₆ (ASCII)	00-FF ₁₆	
		<N>*	 %1906H4E% *
Insert group selection  %1907M%	00-66	00-66	
		00*	 %1907D00% *
Start/End type  %1908M%	ABCD/ABCD	00*	 %1908D00% *
	abcd/abcd	01	 %1908D01%
	ABCD/TN*E	02	 %1908D02%
	abcd/tn*e	03	 %1908D03%

Multiple-scan setting			Single-scan setting
Option bar code	Option	Alpha. entry	
Start/End transmission  %1909M%	Disable	00*	 %1909D00% *
	Enable	01	 %1909D01%
Start/End character equality  %1910M%	Disable	00*	 %1910D00% *
	Enable	01	 %1910D01%



3-22 Code 128

Read:

Format

Data digits (variable)	Check digit (optional)
------------------------	------------------------

Check digit verification: The check digit is made as the sum module 103 of all data digits.



















Check digit transmission: By setting Enable, check digit will be transmitted.

Max./Min. code length: Refer to [Max./Min. code length](#) of [3-17 Code 39](#).

Code ID setting: Refer to [Code ID setting](#) of [3-12 UPC-A](#).

Insertion group selection: Refer to [Insertion group selection](#) of [3-12 UPC-A](#).

Truncate leading zeros: The leading "0" digits of Code 128 barcode characters can be truncated when the feature is enabled.

Multiple-scan setting			Single-scan setting
Option bar code	Option	Alpha. entry	
Read  %2001M%	Disable	00	 %2001D00%
	Enable	01*	 %2001D01% *
Check digit verification  %2002M%	Disable	00	 %2002D00%
	Enable	01*	 %2002D01% *
Check digit transmission  %2003M%	Disable	00*	 %2003D00% *
	Reserved	01	 %2003D01%
Max. code length  %2004M%	00-99	00-99	
		00*	 %2004D00% *
Min. code length  %2005M%	00-99	00-99	
		01*	 %2005D01% *
Code ID setting  %2006M%	00-FF ₁₆ (ASCII)	00-FF ₁₆	
		<K>*	 %2006H4B% *
Insert group selection  %2007M%	00-66	00-66	
		00*	 %2007D00% *
Truncate leading zeros  %2008M%	Disable	00*	 %2008D00% *
	All leading "0"s	01	 %2008D01%
	Only the first "0"	02	 %2008D02%

 %END%

3-23 UCC/EAN 128

Read:

Format

Data digits (variable)	Check digit (optional)
------------------------	------------------------

Check digit verification: The check digit is made as the sum module 103 of all data digits.

Check digit transmission: By setting Enable, check digit will be transmitted.

Max. /Min. code length: Refer to [Max./Min. code length](#) of [3-17 Code 39](#).

Code ID setting: Refer to [Code ID setting](#) of [3-12 UPC-A](#).

Insertion group selection: Refer to [Insertion group selection](#) of [3-12 UPC-A](#).

Truncate leading zeros: Refer to [Truncate leading zeros](#) of [3-23 Code 128](#).

Multiple-scan setting			Single-scan setting
Option bar code	Option	Alpha. entry	
Read  %2501M%	Disable	00	 %2501D00%
	Enable	01*	 %2501D01% *
Check digit verification  %2502M%	Disable	00	 %2502D00%
	Enable	01*	 %2502D01% *
Check digit transmission  %2503M%	Disable	00*	 %2503D00% *
	Reserved	01	 %2503D01%
Max. code length  %2504M%	00-99	00-99	
		00*	 %2504D00% *
Min. code length  %2505M%	00-99	00-99	
		01*	 %2505D01% *
Code ID setting  %2506M%	00-FF ₁₆ (ASCII)	00-FF ₁₆	
		<K>*	 %2506H4B% *
Insert group selection  %2507M%	00-66	00-66	
		00*	 %2507D00% *
Truncate leading zeros  %2508M%	Disable	00*	 %2508D00% *
	All leading "0"s	01	 %2508D01%
	Only the first "0"	02	 %2508D02%



3-24 ISBT 128

Read:
Format

"=" or "&"	Data digits (variable)	Check digit (optional)
------------	------------------------	------------------------















Check digit verification: The check digit is made as the sum module 103 of all data digits.

Check digit transmission: By setting Enable, check digit will be transmitted.

Max./Min. code length: Refer to [Max./Min. code length](#) of 3-17 Code 39.

Code ID setting: Refer to [Code ID setting](#) of 3-12 UPC-A.

Insertion group selection: Refer to [Insertion group selection](#) of 3-12 UPC-A.

Multiple-scan setting			Single-scan setting
Option bar code	Option	Alpha. entry	
Read  %3301M%	Disable	00	 %3301D00%
	Enable	01*	
Check digit verification  %3302M%	Disable	00	 %3302D00%
	Enable	01*	
Check digit transmission  %3303M%	Disable	00*	 %3303D00% *
	Reserved	01	
Max. code length  %3304M%	00-99	00-99	 %3304D00% *
		00*	
Min. code length  %3305M%	00-99	00-99	 %3305D01% *
		01*	
Code ID setting  %3306M%	00-FF ₁₆ (ASCII)	00-FF ₁₆	 %3306H4B% *
		<K>*	
Insert group selection  %3307M%	00-66	00-66	 %3307D00% *
		00*	
 %END%			

3-25 Code 93

Read:
Format

Data digits (variable)	2 check digits (optional)
------------------------	---------------------------



















Check digit verification: The check digit is made as the sum module 47 of the numerical values of all data digits.

Check digit transmission: By setting Enable, check digit will be transmitted.

Max./Min. code length: Refer to [Max./Min. code length](#) of [3-17 Code 39](#).

Code ID setting: Refer to [Code ID setting](#) of [3-12 UPC-A](#).

Insertion group selection: Refer to [Insertion group selection](#) of [3-12 UPC-A](#).

Multiple-scan setting			Single-scan setting
Option bar code	Option	Alpha. entry	
Read  %2101M%	Disable	00	 %2101D00%
	Enable	01*	 %2101D01% *
Check digit verification  %2102M%	Disable	00	 %2102D00%
	Enable	01*	 %2102D01% *
Check digit transmission  %2103M%	Disable	00*	 %2103D00% *
	Enable	01	 %2103D01%
Max. code length  %2104M%	00-99	00-99	
		00*	 %2104D00% *
Min. code length  %2105M%	00-99	00-99	
		01*	 %2105D01% *
Code ID setting  %2106M%	00-FF ₁₆ (ASCII)	00-FF ₁₆	
		<L>*	 %2106H4C% *
Insert group selection  %2107M%	00-66	00-66	
		00*	 %2107D00% *
 %END%			

3-26 Code 11

Read:

Format

Data digits (variable)	Check digit 1 (optional)	Check digit 2 (optional)
------------------------	--------------------------	--------------------------





















Check digit verification: The check digit is presented as the sum module 11 of all data digits.

Check digit transmission: By setting Enable, check digit 1 and check digit 2 will be transmitted upon your selected check digit verification method.

Max./Min. code length: Refer to [Max./Min. code length](#) of [3-17 Code 39](#).

Code ID setting: Refer to [Code ID setting](#) of [3-12 UPC-A](#).

Insertion group selection: Refer to [Insertion group selection](#) of [3-12 UPC-A](#).

Multiple-scan setting			Single-scan setting
Option bar code	Option	Alpha. entry	
Read  %2201M%	Disable	00*	 %2201D00% *
	Enable	01	 %2201D01%
Check digit verification  %2202M%	Disable	00	 %2202D00%
	One digit	01*	 %2202D01% *
	Reserved	02	 %2202D02%
	Reserved	03	 %2202D03%
Check digit transmission  %2203M%	Disable	00*	 %2203D00% *
	Enable	01	 %2203D01%
Max. code length  %2204M%	00-99	00-99	
		00*	 %2204D00% *
Min. code length  %2205M%	00-99	00-99	
		00*	 %2205D00% *
Code ID setting  %2206M%	00-FF ₁₆ (ASCII)	00-FF ₁₆	
		<V>*	 %2206H56% *
Insert group selection  %2207M%	00-66	00-66	
		00*	 %2207D00% *
 %END%			

3-27 MSI/Plessey

Read:

Format

Data digits (variable)	Check digit 1 (optional)	Check digit 2 (optional)
------------------------	--------------------------	--------------------------





















Check digit verification: The MSI/Plessey has one or two optional check digits. There are three methods of verifying check digits, i.e. Mod10, Mod10/10 and Mod 11/10. The check digit 1 and check digit 2 will be calculated as the sum module 10 or 11 of the data digits.

Check digit transmission: By setting Enable, check digit 1 and check digit 2 will be transmitted upon your selected check digit verification method.

Max./Min. code length: Refer to [Max./Min. code length](#) of [3-17 Code 39](#).

Code ID setting: Refer to [Code ID setting](#) of [3-12 UPC-A](#).

Insertion group selection: Refer to [Insertion group selection](#) of [3-12 UPC-A](#).

Multiple-scan setting			Single-scan setting
Option bar code	Option	Alpha. entry	
Read  %2301M%	Disable	00*	 %2301D00% *
	Enable	01	 %2301D01%
Check digit verification  %2302M%	Disable	00*	 %2302D00% *
	1 digit (mod 10)	01	 %2302D01%
	Reserved	02	 %2302D02%
	Reserved	03	 %2302D03%
Check digit transmission  %2303M%	Disable	00*	 %2303D00% *
	Enable	01	 %2303D01%
Max. code length  %2304M%	00-99	00-99	
		00*	 %2304D00% *
Min. code length  %2305M%	00-99	00-99	
		00*	 %2305D00% *
Code ID setting  %2306M%	00-FF ₁₆ (ASCII)	00-FF ₁₆	
		<O>*	 %2306H4F% *
Insert group selection  %2307M%	00-66	00-66	
		00*	 %2307D00% *
 %END%			

3-28 UK/Plessey

Read:
Format

Data digits (variable)	2 check digits (optional)
------------------------	---------------------------



















Check digit verification: The UK/Plessey has one or two optional check digits. The check digit 1 and check digit 2 will be calculated as the sum module 10 or 11 of the data digits.

Check digit transmission: By setting Enable, check digit will be transmitted.

Max./Min. code length: Refer to [Max./Min. code length](#) of [3-17 Code 39](#).

Code ID setting: Refer to [Code ID setting](#) of [3-12 UPC-A](#).

Insertion group selection: Refer to [Insertion group selection](#) of [3-12 UPC-A](#).

Multiple-scan setting			Single-scan setting
Option bar code	Option	Alpha. entry	
Read  %2401M%	Disable	00*	 %2401D00% *
	Enable	01	 %2401D01%
Check digit verification  %2402M%	Disable	00	 %2402D00%
	Enable	01*	 %2402D01% *
Check digit transmission  %2403M%	Disable	00*	 %2403D00% *
	Enable	01	 %2403D01%
Max. code length  %2404M%	00-99	00-99	
		00*	 %2404D00% *
Min. code length  %2405M%	00-99	00-99	
		01*	 %2405D01% *
Code ID setting  %2406M%	00-FF ₁₆ (ASCII)	00-FF ₁₆	
		<U>*	 %2406H55% *
Insert group selection  %2407M%	00-66	00-66	
		00*	 %2407D00% *
 %END%			

3-29 China Post

Read:
Format

11 Data digits

Max. /Min. code length: Refer to [Max./Min. code length](#) of [3-17 Code 39](#). The code length of China Post is 11.

Code ID setting: Refer to [Code ID setting](#) of [3-12 UPC-A](#).

Insertion group selection: Refer to [Insertion group selection](#) of [3-12 UPC-A](#).

Multiple-scan setting			Single-scan setting
Option bar code	Option	Alpha. entry	
Read  %2601M%	Disable	00	 %2601D00%
	Enable	01*	 %2601D01% *
Max. code length  %2604M%	00-99	00-99	
		11*	 %2604D11% *
Min. code length  %2605M%	00-99	00-99	
		11*	 %2605D11% *
Code ID setting  %2606M%	00-FF ₁₆ (ASCII)	00-FF ₁₆	
		<T>*	 %2606H54% *
Insert group selection  %2607M%	00-66	00-66	
		00*	 %2607D00% *
 %END%			

3-30 China Finance

Note: This type of barcode is not Omni-directionally decodable. The encodable character set includes numeric 0 to 9. Among the symbol of 0 to 9, 0 and 2, 4 and 9, 5 and 8, 6 and 7, have the symmetrical pattern; the pattern of 1 and 3 is symmetrical.

Read:

Format

10 Data digits

Max./Min. code length: Refer to Max./Min. code length of 3-17 Code 39.

















Check digit verification: The check digit is made as the sum module 10 of the numerical values of all data digits.









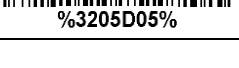







Leading character 5/6/7/8/9 converted to A/B/C/D/E: By setting, leading character 5/6/7/8/9 can be converted to A/B/C/D/E.

Leading character assignment: By setting, only the barcode with the assigned leading character can be output.

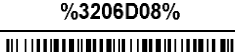
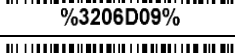
Code ID setting: Refer to Code ID setting of 3-12 UPC-A.

Insertion group selection: Refer to Insertion group selection of 3-12 UPC-A.

Multiple-scan setting			Single-scan setting
Option bar code	Option	Alpha. entry	
Read  %3201M%	Disable	00	 %3201D00%
	Enable	01*	 %3201D01% *
Max. code length  %3202M%	00-99	00-99	
		10*	 %3202D10% *
Min. code length  %3203M%	00-99	00-99	
		10*	 %3203D10% *
Check digit verification  %3204M%	Disable	00*	 %3204D00% *
	Reserved	01	 %3204D01%
Leading character 5/6/7/8/9 converted to A/B/C/D/E  %3205M%	Disable	00	 %3205D00%
	Enable	01*	 %3205D01% *
	Only 5 converted to A	02	 %3205D02%
	Only 6 converted to B	03	 %3205D03%
	Only 7 converted to C	04	 %3205D04%
	Only 8 converted to D	05	 %3205D05%

Multiple-scan setting			Single-scan setting
Option bar code	Option	Alpha. entry	
	Only 9 converted to E	06	 %3205D06%
Leading character assignment  %3206M%	Disable	00	 %3206D00%
	Assigned to 0	01*	 %3206D01% *
	Assigned to 5(A)	02	 %3206D02%
	Assigned to 6(B)	03	 %3206D03%
	Assigned to 7(C)	04	 %3206D04%
	Assigned to 8(D)	05	 %3206D05%
	Assigned to 9(E)	06	 %3206D06%
	Assigned to 1	07	 %3206D07%
	Assigned to 2	08	 %3206D08%
	Assigned to 3	09	 %3206D09%
	Assigned to 4	10	 %3206D10%
Code ID setting  %3207M%	00-FF ₁₆ (ASCII)	00-FF ₁₆	
		<Y>*	 %3207H59% *
Insert group selection  %3208M%	00-66	00-66	
		00*	 %3208D00% *
 %END%			

3-31 GS1 DataBar (GS1 DataBar Truncated)

GS1 DataBar Truncated is structured and encoded the same as the standard GS1 DataBar format, except its height is reduced to a 13 modules minimum; while GS1 DataBar should have a height greater than or equal to 33 modules.

Read:
Format

16 Data digits











Code ID setting: Refer to Code ID setting of [3-12 UPC-A](#).

Insertion group selection: Refer to Insertion group selection of [3-12 UPC-A](#).

Conversion:

UCC/EAN 128- Refer to Code ID transmission of [3-42 String transmission](#),]Cm will be identified as AIM ID.

UPC-A or EAN-13- Barcode beginning with a single zero as the first digit has the leading “010” stripped and the barcode reported as EAN-13. Barcode beginning with two or more zeros but not six zeros has the leading “0100” stripped and the barcode reported as UPC-A.

Multiple-scan setting			Single-scan setting
Option bar code	Option	Alpha. entry	
Read  %2701M%	Disable	00	 %2701D00%
	Enable	01*	
Code ID setting  %2702M%	00-FF ₁₆ (ASCII)	00-FF ₁₆	 %2702H52% *
		<R>*	
Insert group selection  %2703M%	00-66	00-66	 %2703D00% *
		00*	
Conversion  %2704M%	None	00*	 %2704D00% *
	UCC/EAN 128	01	 %2704D01%
	UPC-A or EAN-13	02	 %2704D02%

 %END%

3-32 GS1 DataBar Limited











Read:
Format

16 Data digits

Code ID setting: Refer to Code ID setting of [3-12 UPC-A](#).

Insertion group selection: Refer to Insertion group selection of [3-12 UPC-A](#).

Conversion: Refer to Conversion of [3-31 GS1 DataBar \(GS1 DataBar Truncated\)](#).

Multiple-scan setting			Single-scan setting
Option bar code	Option	Alpha. entry	
Read  %2801M%	Disable	00	 %2801D00%
	Enable	01*	 %2801D01% *
Code ID setting  %2802M%	00-FF ₁₆ (ASCII)	00-FF ₁₆	
		<R>*	 %2802H52% *
Insert group selection  %2803M%	00-66	00-66	
		00*	 %2803D00% *
Conversion  %2804M%	None	00*	 %2804D00% *
	UCC/EAN 128	01	 %2804D01%
	UPC-A or EAN-13	02	 %2804D02%

 %END%

3-33 GS1 DataBar Expanded

Read:
Format















Data characters (variable)

Code ID setting: Refer to Code ID setting of [3-12 UPC-A](#).

Insertion group selection: Refer to Insertion group selection of [3-12 UPC-A](#).

Conversion:

UCC/EAN 128- Refer to Code ID transmission of [3-42 String transmission](#),]Cm will be identified as AIM ID.





Multiple-scan setting			Single-scan setting
Option bar code	Option	Alpha. entry	
Read  %2901M%	Disable	00	 %2901D00%
	Enable	01*	 %2901D01% *
Max. code length  %2902M%	00-99	00-99	
		00*	 %2902D00% *
Min. code length  %2903M%	00-99	00-99	
		01*	 %2903D01% *
Code ID setting  %2904M%	00-FF ₁₆ (ASCII)	00-FF ₁₆	
		<R>*	 %2904H52% *
Insert group selection  %2905M%	00-66	00-66	
		00*	 %2905D00% *
Conversion  %2906M%	None	00*	 %2906D00% *
	UCC/EAN 128	01	 %2906D01%

 %END%

3-34 PDF417

Read:
Format



Data characters (variable)

Multiple-scan setting			Single-scan setting
Option bar code	Option	Alpha. entry	
Read  %3001M%	Disable	00	 %3001D00%
	Enable	01*	 %3001D01% *
 %END%			

3-35 MicroPDF417

Read:
Format

Data characters (variable)





Multiple-scan setting			Single-scan setting
Option bar code	Option	Alpha. entry	
Read  %3101M%	Disable	00	 %3101D00%
	Enable	01*	 %3101D01% *

 %END%

3-36 QR Code

Read:
Format





Data characters (variable)

Multiple-scan setting			Single-scan setting
Option bar code	Option	Alpha. entry	
Read  %4001M%	Disable	00	 %4001D00%
	Enable	01*	 %4001D01%*
 %END%			

3-37 Data Matrix

Read:
Format





Data characters (variable)

Multiple-scan setting			Single-scan setting
Option bar code	Option	Alpha. entry	
Read  %4101M%	Disable	00	 %4101D00%
	Enable	01*	 %4101D01% *
 %END%			

3-38 Aztec Code

Read:
Format

Data characters (variable)

Multiple-scan setting			Single-scan setting
Option bar code	Option	Alpha. entry	
Read  %4301M%	Disable	00	 %4301D00%
	Enable	01*	 %4301D01% *
 %END%			

3-39 G1-G6 & C1-C2 & FN1 substitution string setting

Format of barcode data transmission:

Prefix	Code name	Preamble	Code ID	Code length	Code data	Code ID	Postamble	Suffix
--------	-----------	----------	---------	-------------	-----------	---------	-----------	--------

Suffix string setting: The <enter> key is represented in different ASCII when it is applied by different OS. For a Windows/DOS OS, <enter> is represented as <CR><LF> (0x0D 0x0A); for an Apple MAC OS, <enter> is represented as <CR> (0x0D); for a Linux/Unix OS, <enter> is represented as <LF> (0x0A).

Prefix/Suffix/Preamble/Postamble string setting:

They are appended to the data automatically when a barcode is decoded.

Example: Add a symbol of “\$” as a prefix for all symbols.

Steps:

- 1) Scan the option barcode of **Prefix string setting**.
- 2) Use the ASCII table to find the value of \$→24.
- 3) Scan **2** and **4** from the barcode on the last page.
- 4) Scan **END** barcode.

Scanning steps: Scan the following barcodes in order.

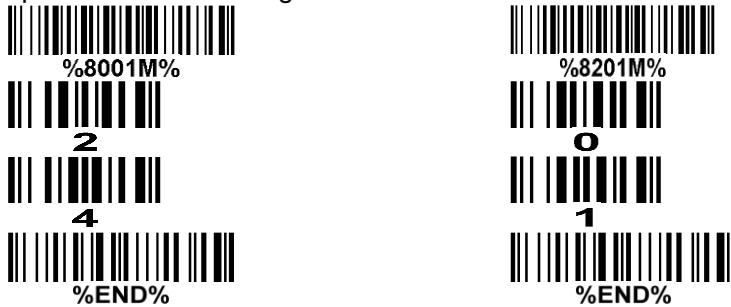

Insert G1/G2/G3/G4 string setting: The scanner offers 4 positions and 4 character strings to insert among the symbol.

Example: Set G1 string to be “AB”.

Original code data	“1 2 3 4 5 6”
Output code data	“1 2 A B 3 4 5 6”

Steps:

- 1) Scan the option barcode of **Insert G1 string setting**.
- 2) Use the ASCII table to find the value of A→41, B→42.
- 3) Scan **4**, **1** and **4**, **2** from the barcode on the last page.
- 4) Scan **END** barcode.
- 5) Refer to [3-41 G1-G4 string position & Code ID position](#).
- 6) Refer to [3-7 Handheld scan & some global settings](#).



Testing barcode:



123456

FN1 substitution string setting: The FN1 character (0x1D) in an UCC/EAN128 barcode, or a Code 128 barcode, or a GS1 DataBar barcode can be substituted with a defined string.

Truncate leading G5 string setting: By setting, a defined leading character or string can be truncated. Also a single character can be un-defined.

Repeat of a G5 character setting: While G5 is set as a single defined/un-defined character, G5 can also be set to be repeated. This setting is ignored when the truncate number is more than the barcode data characters. The option of "FF" for this setting is not active while the option of Truncate leading G5 string setting is "00".

Example: Truncate all leading zeros for all symbols.

Original code data	"0 0 0 1 2 3 4 5 6"
Output code data	"1 2 3 4 5 6"

Steps: scan the following data in order.



Testing barcode:



000123456

Truncate ending G6 string setting: By setting, a defined ending character or string can be truncated. Also a single character can be un-defined.

Repeat of a G6 character setting: While G5 is set as a single defined/un-defined character, G6 can also be set to be repeated. This setting is ignored when the truncate number is more than the barcode data characters. The option of "FF" for this setting is not active while the option of Truncate ending G6 string setting is "00".

Single character C1/C2 replacement: By setting, a defined character in the data string can be replaced by another defined character. The C1 and C2 replacement are applied simultaneously.

Example: Replace all the "A" character in a data string to be "B" character.

Original code data	"1 2 3 A 5 A"
Output code data	"1 2 3 B 5 B"

Steps: scan the following barcodes in order. The ASCII value for "A" is 41, and the ASCII value for "B" is 42.

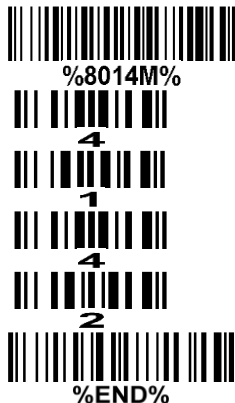

Testing barcode:



Multiple-scan setting			Single-scan setting
Option bar code	Option	Alpha. entry	
Prefix string setting  %8001M%	0-22 characters	00-FF ₁₆	
	None	00*	 %8001H00% *
Suffix string setting  %8002M%	0-22 characters	00-FF ₁₆	
	<ENTER>	0D0A*	
Preamble string setting  %8003M%	0-22 characters	00-FF ₁₆	
	None	00*	 %8003H00% *
Postamble string setting  %8004M%	0-22 characters	00-FF ₁₆	
	None	00*	 %8004H00% *
Insert G1 string setting  %8005M%	0-22 characters	00-FF ₁₆	
	None	00*	 %8005H00% *
Insert G2 string setting  %8006M%	0-22 characters	00-FF ₁₆	
	None	00*	 %8006H00% *
Insert G3 string setting  %8007M%	0-22 characters	00-FF ₁₆	
	None	00*	 %8007H00% *
Insert G4 string setting  %8008M%	0-22 characters	00-FF ₁₆	
	None	00*	 %8008H00% *
FN1 substitution string setting  %8009M%	0-4 characters	00-FF ₁₆	
	<SP>	20*	 %8009H20% *
Truncate leading G5 string setting  %8010M%	A un-defined character	00	 %8010H00%
	1-22 defined characters	01-7F ₁₆	
	<0>	30*	 %8010H30% *

Multiple-scan setting			Single-scan setting
Option bar code	Option	Alpha. entry	
Repeat of a G5 character setting  %8011M%	Once	01*	 %8011H01% *
	Defined times	01-22	
	Un-defined times (All)	FF	 %8011HFF%
Truncate ending G6 string setting  %8012M%	A un-defined character	00	 %8012H00%
	1-22 defined characters	01-7F ₁₆	
	<0>	30*	 %8012H30% *
Repeat of a G6 character setting  %8013M%	Once	01*	 %8013H01% *
	Defined times	01-22	
	Un-defined times (All)	FF	 %8013HFF%
Single character C1 replacement  %8014M%	<0000>	0000*	
		0000-FFFF ₁₆	
Single character C2 replacement  %8015M%	<0000>	0000*	
		0000-FFFF ₁₆	



3-40 G1-G4 string position & Code ID position

Format of barcode data transmission:

Prefix	Code name	Preamble	Code ID	Code length	Code data	Code ID	Postamble	Suffix
--------	-----------	----------	---------	-------------	-----------	---------	-----------	--------

Insert G1/G2/G3/G4 string position: The scanner offers 4 positions to insert strings among the symbol. In case of the insertion position is greater than the length of the symbol, the insertion of string is not effective.

Code ID position: It is allowed to select different positions of code ID placement.

Multiple-scan setting			Single-scan setting
Option bar code	Option	Alpha. entry	
Insert G1 string position  %8101M%	00-99	00-99	 %8101D00% *
		00*	
Insert G2 string position  %8102M%	00-99	00-99	 %8102D00% *
		00*	
Insert G3 string position  %8103M%	00-99	00-99	 %8103D00% *
		00*	
Insert G4 string position  %8104M%	00-99	00-99	 %8104D00% *
		00*	
Code ID position  %8105M%	Before code data	00*	 %8105D00% *
	After code data	01	 %8105D01%
 %END%			

3-41 String transmission

Note: The information in this chapter is closely related to the chapter of String setting.

Format of barcode data transmission:

Prefix	Code name	Preamble	Code ID	Code length	Code data	Code ID	Postamble	Suffix
--------	-----------	----------	---------	-------------	-----------	---------	-----------	--------

Prefix transmission: By setting Enable, prefix will be appended before the data transmitted.

Suffix transmission: By setting Enable, suffix will be appended after the data is transmitted.

Code name transmission: By setting Enable, code name will be transmitted before code data.

Preamble transmission: By setting Enable, preamble will be appended before the data transmitted.

Postamble transmission: By setting Enable, postamble will be appended after the data is transmitted.

Code ID transmission: Code ID can be transmitted in the format of either Proprietary ID or AIM ID. Refer to the chapter of Default setting for each barcode.

Code length transmission: The length of code data string can be transmitted before the code data when Enable is selected. The length is represented by a number with two digits.





























Case conversion: The characters within code data or the whole output string can be set in either upper case or lower case.





FN1 substitution transmission: The scanner supports a FN1 substitution feature for keyboard wedge, USB and RS-232 interface. The replacement string of FN1 can be chosen by user (see [3-40 G1-G6 & C1-C2 & FN1 substitution string setting](#)).

All-non-printable-character string transmission with string setting: By setting enable, all string settings, e.g. `[Preamble transmission]` or `[Insert G1 string setting]`, are active for an all-non-printable-character string. Here a non-printable character means a character with ASCII value between 0x00 to 0x1F.

Transmit the first N data characters only: The scanner supports to only transmit the first N data characters of a barcode. The number of N can be set as a digit between 1 and 99.

Transmit the last N data characters only: The scanner supports to only transmit the last N data characters of a barcode. The number of N can be set as a digit between 1 and 99.

Multiple-scan setting			Single-scan setting
Option bar code	Option	Alpha. entry	
Prefix transmission  %8201M%	Disable	00*	 %8201D00% *
	Enable	01	 %8201D01%
Suffix transmission  %8202M%	Disable	00	 %8202D00%
	Enable	01*	 %8202D01% *
Code name transmission  %8203M%	Disable	00*	 %8203D00% *
	Enable	01	 %8203D01%
Preamble transmission  %8204M%	Disable	00*	 %8204D00% *
	Enable	01	 %8204D01%
Postamble transmission  %8205M%	Disable	00*	 %8205D00% *
	Enable	01	 %8205D01%
Code ID transmission  %8206M%	Disable	00*	 %8206D00% *
	Proprietary ID	01	 %8206D01%
	AIM ID	02	 %8206D02%
Code length transmission  %8207M%	Disable	00*	 %8207D00% *
	Enable	01	 %8207D01%
Case conversion  %8208M%	Disable	00*	 %8208D00% *
	Upper (data only)	01	 %8208D01%
	Lower (data only)	02	 %8208D02%
	Upper (whole string)	03	 %8208D03%
	Lower (whole string)	04	 %8208D04%
FN1 substitution transmission	Disable	00*	 %8209D00% *

Multiple-scan setting			Single-scan setting
Option bar code	Option	Alpha. entry	
 %8209M%	Keyboard wedge/USB	01	 %8209D01%
	RS-232	02	 %8209D02%
	Keyboard wedge / USB / RS-232	03	 %8209D03%
All-non-printable-character string transmission with string setting  %8210M%	Disable	00*	 %8210D00% *
	Enable	01	 %8210D01%
Transmit the first N data characters only  %8211M%	All	99*	 %8211D99% *
	01-99		
Transmit the last N data characters only  %8212M%	All	99*	 %8212D99% *
	01-99		
 %END%			

4 Test barcode symbols



UCC/EAN 128



Code 11
(Default setting: Read disable)



MSI/Plessey
(Default setting: Read disable)



UK/Plessey



ISBN/ISSN



China Post



GS1 DataBar (GS1 DataBar Truncated)



GS1 DataBar Limited



GS1 DataBar Expanded



PDF417



MicroPDF417



QR code



Data Matrix



Aztec Code



12345678901234567890

Han Xin Code

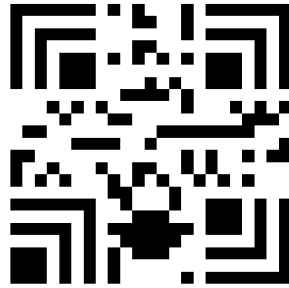

SAMPLE

5 Maintenance

Cleaning the scan window is the only maintenance required. A dirty window may affect scanning accuracy.

- 1) Do not allow any abrasive material to touch the window.
- 2) Remove any dirt particles with a damp cloth.
- 3) Wipe the window using a tissue moistened with water.
- 4) Do not spray water or other cleaning liquids directly into the window.
- 5) Use a piece of soft and dry cloth when cleaning the scanner.

6 ASCII Table

H L		for keyboard wedge		for RS-232	
		0	1	0	1
0		Null		NUL	DLE
1		Up	F1	SOH	DC1
2		Down	F2	STX	DC2
3		Left	F3	ETX	DC3
4		Right	F4	EOT	DC4
5		PgUp	F5	ENQ	NAK
6		PgDn	F6	ACK	SYN
7			F7	BEL	ETB
8		Bs	F8	BS	CAN
9		Tab	F9	HT	EM
A			F10	LF	SUB
B		Home	Esc	VT	ESC
C		End	F11	FF	FS
D		Enter	F12	CR	GS
E		Insert	Ctrl+	SO	RS
F		Delete	Alt+	SI	US

Notes: The 2nd and the 3rd columns above are used for keyboard wedge only.

H L	2	3	4	5	6	7
0	SP	0	@	P	`	p
1	!	1	A	Q	a	q
2	"	2	B	R	b	r
3	#	3	C	S	c	s
4	\$	4	D	T	d	t
5	%	5	E	U	e	u
6	&	6	F	V	f	v
7	'	7	G	W	g	w
8	(8	H	X	h	x
9)	9	I	Y	i	y
A	*	:	J	Z	j	z
B	+	;	K	[k	{
C	,	<	L	\	l	
D	-	=	M]	m	}
E	.	>	N	^	n	~
F	/	?	O	_	o	DEL

Example: ASCII "A" = "41".

7 Barcode representing non-printable character

Notes to make the following barcode:

1. According to different barcode printing software, the method of printing following barcode is different.

2. If using CODESOFT software, firstly read the information through “Help→Index→Code128→Special input syntax”. Also refer to ASCII table. For example, if we wish to make “F1” barcode, select “Code128”, then select “CODE A” type, and input “{DC1}” as data.



8 Return default parameters



%%ADEF

All parameters of handheld unit return to default setting

WARNING: If you wish to return all parameters of the handheld unit, including radio communication setting, to default setting, please scan the barcode above.



%BADEF

All parameters of cradle return to default setting

WARNING: If you wish to return all parameters of the cradle, including radio communication setting, to default setting, please scan the barcode above.



%%%DEF

Some parameters of handheld unit return to default setting

WARNING: If you wish to return all parameters of the handheld unit, excluding radio communication setting, to default setting, please scan the barcode above.



%%BDEF

Some parameters of cradle return default value initialization

WARNING: If you wish to return all parameters of the cradle, excluding radio communication setting, to default setting, please scan the barcode above.



%PWOFF

Turn off handheld unit

If you wish to turn off the handheld unit, please scan the barcode above. If you want to turn on the handheld unit again, please keep the trigger key being pressing for 2 seconds.

If you want to turn off the handheld unit via trigger key, please press and hold the trigger key, after the laser beam turns off, wait for another 5 seconds, the handheld unit will be turned off, then you can release the trigger key at this moment.

9 Display firmware version & radio communication setting



%%BVER

Cradle firmware version display

If you wish to display the firmware version of the cradle, please scan the barcode above.



%%%VER

Handheld unit firmware version display

If you wish to display the firmware version of the handheld unit, please scan the barcode above.



%%BSCI

Cradle radio communication setting display

If you wish to display the radio communication setting of the cradle, please scan the barcode above.



%%%SCI

Handheld unit radio communication setting display

If you wish to display the radio communication setting of the handheld unit, please scan the barcode above.

10 Configuration alphanumeric entry barcode



To finish parameter setting, please scan the bar code below.

