

CCD Barcode Scanner

- MS250 -

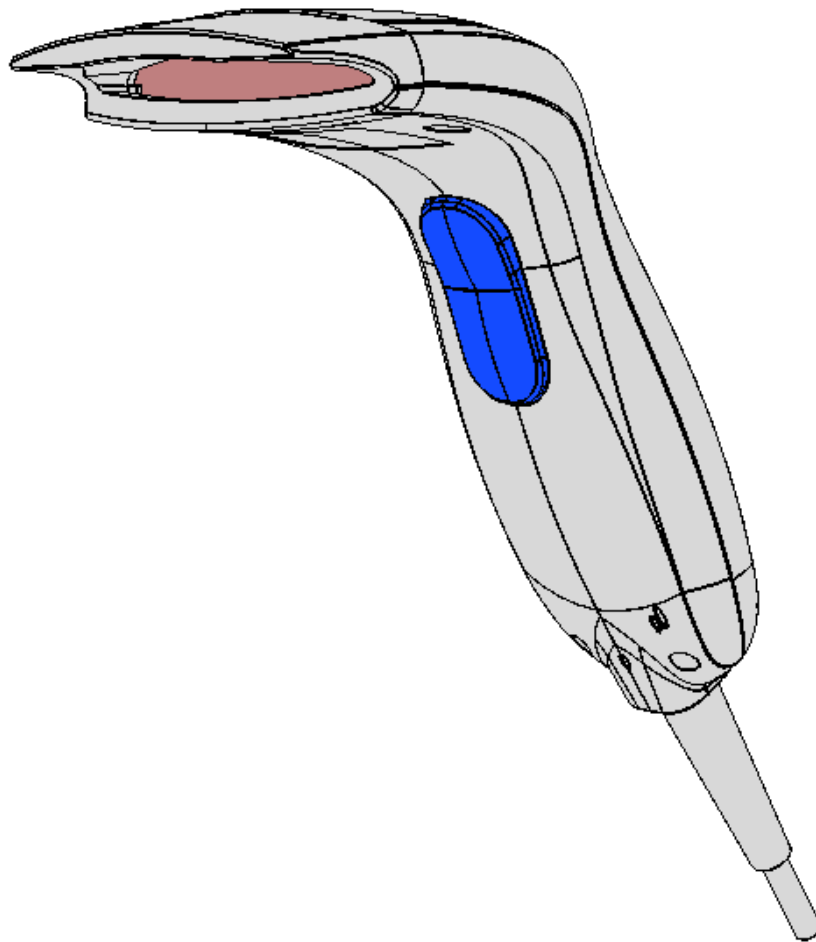

Disclaimer

Unitech reserves the right to make changes in specifications and other information contained in this document without prior notice, and the reader should in all cases consult Unitech to determine whether any such changes have been made. The information in this publication does not represent a commitment on the part of Unitech.

Unitech shall not be liable for technical or editorial errors or omissions contained herein: nor for incidental or consequential damages resulting from the furnishing, performance, or use of this manual.

This document contains propriety information that is protected by copyright. All rights reserved. No part of this document may be photocopied, reproduced, or translated into another language without the prior written consent of Unitech.

© 2013 Unitech. All rights reserved.

Trademarks

Microsoft and Windows are trademarks or registered trademarks of Microsoft Corporation. Other product names mentioned in this manual may be trademarks or registered trademarks of their respective companies and are the property of their respective owners.

Regulatory Compliance Statements

RoHS Statement



This device conforms to RoHS (Reduction Of Hazardous Substances) European Union regulations that set maximum concentration limits on hazardous materials used in electrical and electronic equipment.

Table of Contents

Disclaimer	I
Trademarks.....	I
Regulatory Compliance Statements	I
Table of Contents	II
Chapter 1. Quick Tour	1
Chapter 2. Installation and Operation	2
Chapter 3. CONFIGURATION	3
3.1 Flow Chart	3
3.2 Loop of Programming	4
3.3 Factory Default Settings.....	4
3.4 Main Page of Configuration	4
Chapter 4 Interface and Reading Mode Selection	6
4.1 Interface Selection.....	6
4.2 Reading Mode Selection.....	6
Chapter.5 Communication Parameters	8
5.1 RS232 Communication Parameters	8
5.2 Keyboard Wedge Mode Parameters.....	10
5.3 Output Characters Parameters	13
5.4 Wand Emulation Mode Parameters	15
Chapter. 6 Bar Codes & Others	16
6.1 Symbologies Selection	16
6.2 UPC/EANI/JAN Parameters.....	20
6.3 Code 39 Parameters.....	23
6.4 Code 128 Parameters.....	25
6.5 Interleave 25 Parameters.....	27
6.6 Industrial 25 Parameters.....	29
6.7 Matrix 25 Parameters	31
6.8 CODABAR/NW7 Parameters.....	32
6.9 Code 93 Parameters.....	35
6.10 Code 11 Parameters	36
6.11 MSI/PLESSEY Code Parameters	38
6.12 LCD25 Parameters	39
6.15 GS1 Databar.....	42
Chapter 7 Miscellaneous Parameters	44

7.1 Language Selection	44
7.2 Bar Code ID	45
7.3 Reading Level.....	48
7.4 Accuracy	48
7.5 Buzzer Beep Tone	49
7.6 Sensitivity of Continuous Reading Mode	49
7.7 Reverse Output Characters	50
7.8 Setup Deletion	50
7.9 Setup Insertion	54
Appendix A Decimal Value Table.....	58
Appendix B ASCII Table	58
Appendix C Function Key Table	62
8 SPECIFICATION.....	63
8.1 Dimensions	63
8.2 Technical Data	64
8.3. Readable Symbology.....	65
8.4. Reliability	66

Chapter 1. Quick Tour

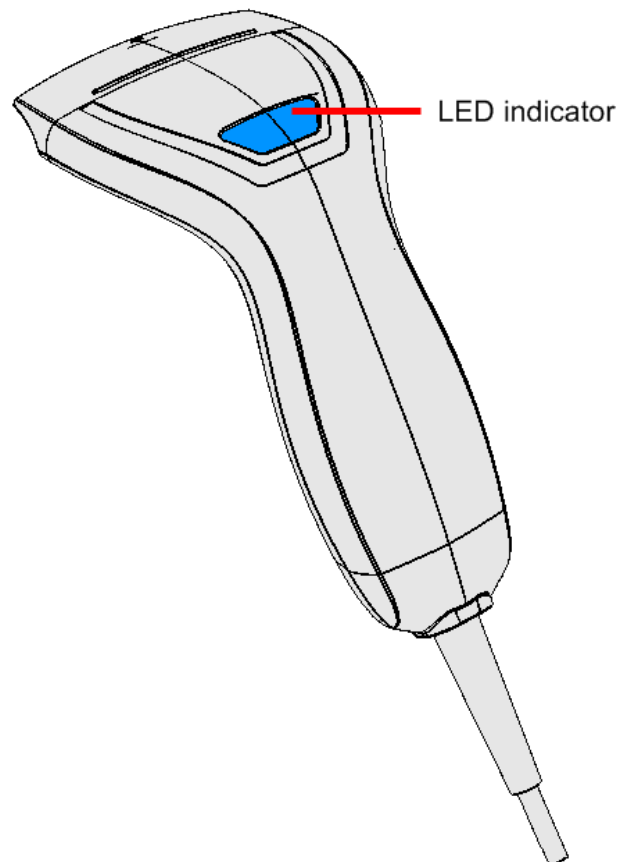
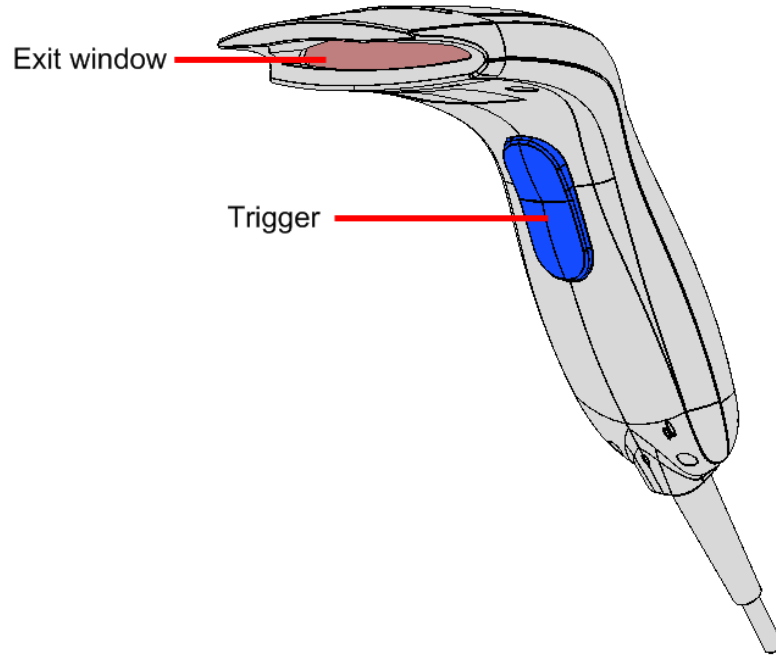

Chapter 2. Installation and Operation

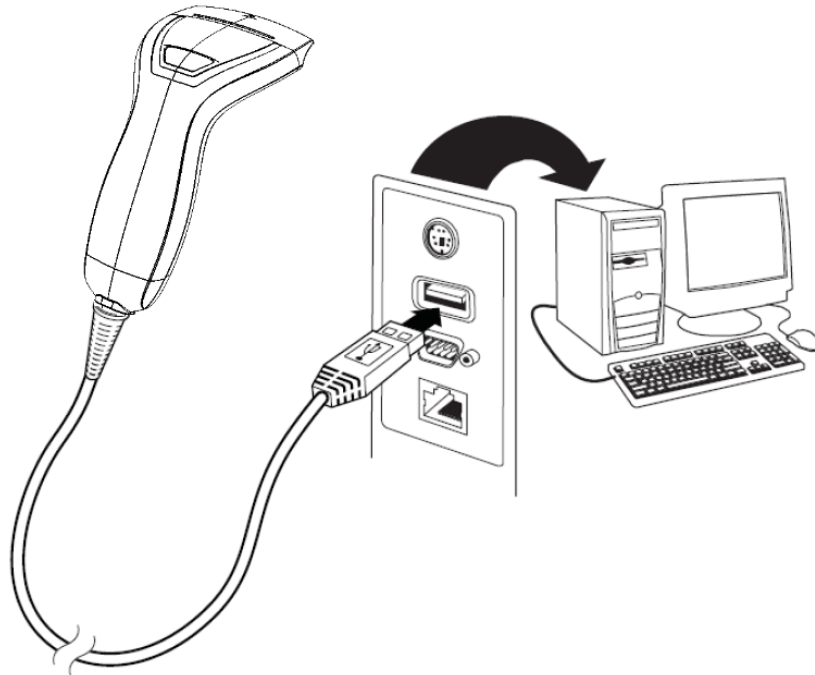

1. Connect the USB connector of MS 250 to the USB port of a host PC.

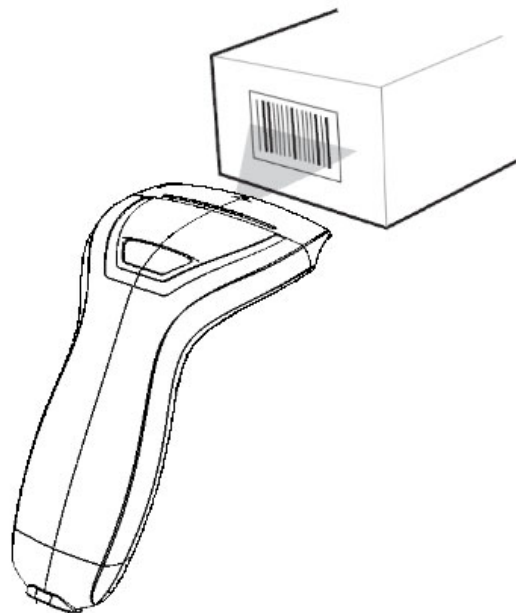

2. Aim at the barcode and pull the trigger to scan the barcode.

Chapter 3. CONFIGURATION

3.1 Flow Chart

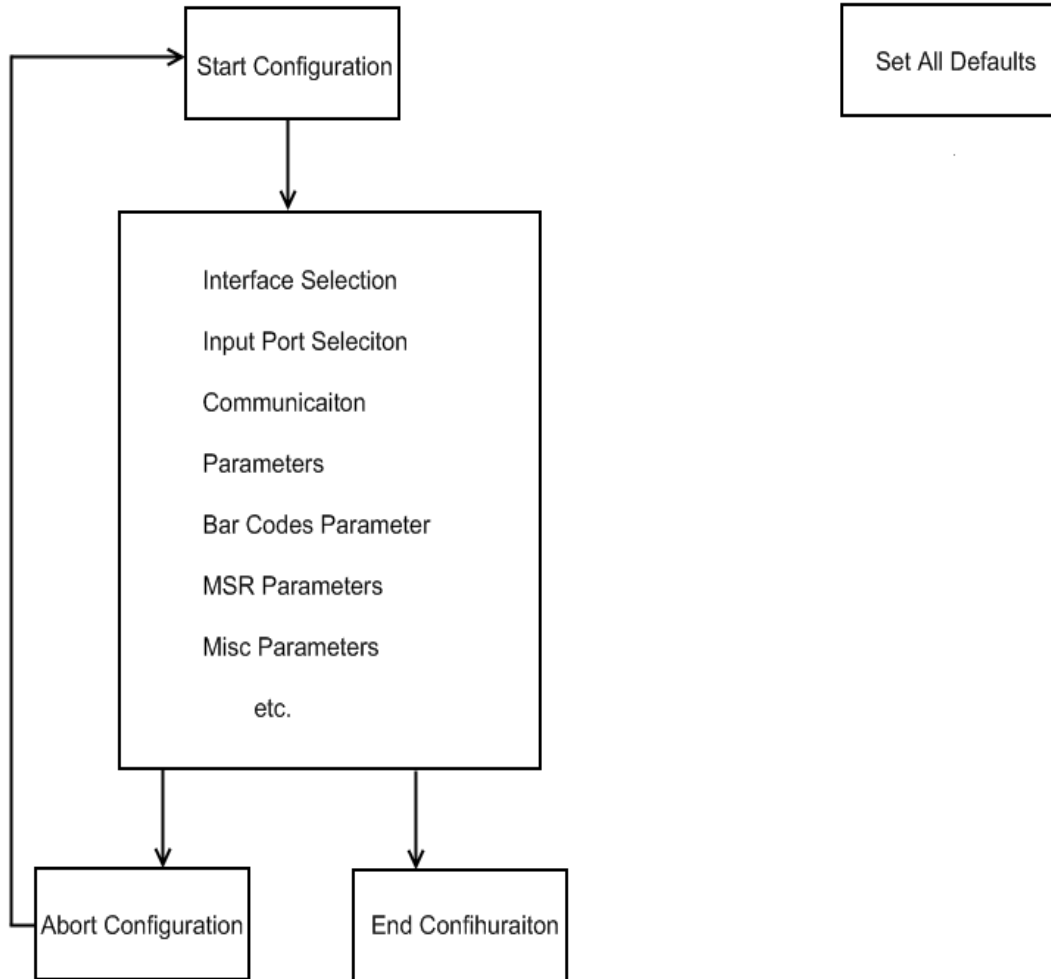

3.2 Loop of Programming

The philosophy of programming parameters has been shown on the flow chart of 3.1. Basically user should

1. Scan Start of Configuration.
2. Scan all necessary labels for parameters that meet applications.
3. Scan End of Configuration to end the programming.
4. To permanently save the settings you programmed, just scan label for Save Parameters.

To go back to the Default Settings, just scan label for Set All Defaults.

3.3 Factory Default Settings

The factory default settings are shown with <> and bold in the following sections. You can make your own settings by following the procedures in this manual. If you want to save the settings permanently, you should scan the label of “Save Parameters“ in chapter 3.4, otherwise the settings will not be saved after the decoder power is off, and all settings will go back to previous settings.

By scanning “Set All Default“ label, the settings will go back to the factory default settings.

3.4 Main Page of Configuration

Set All Defaults	 %\$+/2
Start Configuration	 %\$+/3
End Configuration	 %\$+/4
Abort Configuration	 %\$+/6
Version Information	 %\$+/5

Save Parameters



Recall Stored Parameters



Save Parameters -

The parameter settings will be saved permanently.

Recall Stored Parameters -

Replace the current parameters by the parameters you saved last time.

Set All Defaults -

Set all the parameters to the factory default settings.

Abort Configuration -





Terminate current programming status.

Version Information -

Display the decoder version information and date code.

Chapter 4 Interface and Reading Mode Selection

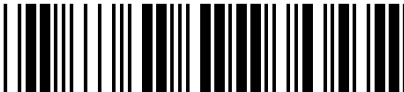
4.1 Interface Selection

<USB Mode>	 %0X08
Keyboard Mode	 %00U0
RS232 Mode	 %00U8
WAND Emulation	 %00M2
Virtual Com Port Mode	 %0088

4.2 Reading Mode Selection

<Trigger ON/OFF>	 %0270
Good Read OFF	 %0271
Continuous/Trigger OFF	 %0272
Testing	 %0275

Continuous/Auto Power On



%0273

Flash



%0274

Flash/Auto Power On



%0276

Reserved1



%0277

Auto Sense (Option)



%09F8

Reserved3



%09F9

Reserved4



%09FA

Reserved5



%09FB

Chapter.5 Communication Parameters

5.1 RS232 Communication Parameters

A. Set Up BAUD Rate

1200



2400



4800



<9600>



19200



38400



B. Set Up Data Bits

7 Data Bits



<8 Data Bits>



C. Set Up Stop Bits

<1 Bit>



2 Bits



D. Set Up Parity

<None>



Even



Odd



Mark



Space



E. Handshaking

RTS/CTS Enable



<RTS/CTS Disable>



ACK/NAK Enable



%0144

<ACK/NAK Disable>



%0140

XON/XOFF Enable



%03K4

<XON/XOFF Disable>



%03K0

5.2 Keyboard Wedge Mode Parameters

A. Terminal Type

<IBM PC/AT, PS/2>



%0ZF0

IBM PC/XT



%0ZF1

IBM PS/2 25, 30



%0ZF2

NEC 9800











%0ZF3

Apple Desktop Bus(ADB)



%0ZF4

IBM 5550	 <i>%OZF5</i>
IBM 122 Key (1)	 <i>%OZF6</i>
IBM 102 Key	 <i>%OZF7</i>
IBM 122 Key (2)	 <i>%OZF8</i>
Reserved 1	 <i>%OZF9</i>
Reserved 2	 <i>%OZFA</i>
Reserved 3	 <i>%OZFB</i>
Reserved 4	 <i>%OZFC</i>
Reserved 5	 <i>%OZFD</i>

B. Upper/Lower Case

<No Change>



%0330

Upper Case



%0331

Lower Case



%0332

C. Caps Lock Detection

Enable



%0X88

<Disable>



%0X80

D. Send Character by ALT Method

Enable



%0308

<Disable>



%0300

E. Select Numerical Pad

ON	 %01K4
<OFF>	 %01K0

5.3 Output Characters Parameters

A. Select Terminator

<CR+LF>	 %7S2+
None	 %7S7+
CR	 %7S0+
LF	 %7S1+
Space	 %7S4+
HT(TAB)	 %7S3+
STX-ETX	 %7S5+

B. Time-out Between Characters

<0 ms>	 <i>%0070</i>
5 ms	 <i>%0071</i>
10 ms	 <i>%0072</i>
25 ms	 <i>%0073</i>
50 ms	 <i>%0074</i>
100 ms	 <i>%0075</i>
200 ms	 <i>%0076</i>
300 ms	 <i>%0077</i>

5.4 Wand Emulation Mode Parameters

A. TTL Level Representation

<Bar Equals High>



%02K4

Bar Equals Low



%02K0

B. Scan Speed Selection

<Fast>



%0288

Slow



%0280

C. Output Format Selection

<Output as Code 39>



%0208

Output as Code 39 Full ASCII



%0200









Output as Original Code Format























%0XK4

Chapter. 6 Bar Codes & Others

6.1 Symbologies Selection

UPC-A <ON>	 %0A44
OFF	 %0A40
UPC-E <ON>	 %0B08
OFF	 %0B00
EAN-13/JAN-13/ISBN-13<ON>	 %0A22
OFF	 %0A20
EAN-8/JAN-8 <ON>	 %0A11
OFF	 %0A10
CODE 39 <ON>	 %0E08
OFF	 %0E00

CODE 128 <ON>	 %0F08
OFF	 %0F00
CODABAR/NW7 <ON>	 %0J08
OFF	 %0J00
Interleave 25 <ON>	 %0G08
OFF	 %0G00
Industrial 25 ON	 %0H08
<OFF>	 %0H00
Matrix 25 ON	 %0I08
<OFF>	 %0I00

CODE 93 ON	 %OKO8
<OFF>	 %OKO0
CODE 11 ON	 %OLO8
<OFF>	 %OLO0
China Postage ON	 %OMO8
<OFF>	 %OMO0
MSI/PLESSEY ON	 %ONOS
<OFF>	 %ONOO
Code 2 of 6 ON	 %OPOS
<OFF>	 %OPOO

LCD25 ON	 %0Q08
<OFF>	 %0Q00
Reserved5 ON	 %0R08
<OFF>	 %0R00
Reserved6 ON	 %0S08
<OFF>	 %0S00
GS1 DataBar Omnidirectional ON	 %0U08
<OFF>	 %0U00
GS1 DataBar Limited ON	 %0V08
<OFF>	 %0V00
GS1 DataBar Expanded ON	 %0W08

<OFF>



Select All Bar Codes

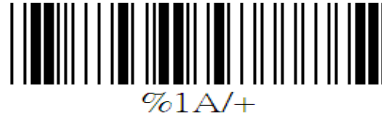

6.2 UPC/EAN/JAN Parameters

A Reading Type

UPCA=EAN13 ON



UPCA=EAN13<OFF>



ISBN-1C Enable



ISBN-13 <Enable>



ISSN Enable



ISSN <Disable>



Decode with Supplement



<Auto discriminate Supplement>



%0108

Expand UPC-E Enable



%0BH1

Expand UPC-E <Disable>



%0BH0

EAN8=EAN13 Enable



%0A08

EAN8=EAN13 <Disable>



%0A00

GTIN Format Enable



%0X44

GTIN Format <Disable>



%0X40

B Supplemental Set Up

<Not Transmit>



%0B33

Transmit 2 Code



%0B31

Transmit 5 Code



%0B32

Transmit 2&5 Code



%0B30

C Check Digit Transmission

UPC-A Check Digit Transmission
<ON>



%0AI2

OFF



%0AI0

UPC-E Check Digit Transmission
<ON>



%0BI2

OFF



%0BI0

EAN-8 Check Digit Transmission
<ON>



%0A88

OFF



%0A80

EAN-13 Check Digit Transmission
<ON>



%0AH1

OFF



%0AH0

ISSN Check Digit Transmission
<ON>



OFF



6.3 Code 39 Parameters

A Type of Code

<Standard>



Full ASCII



Italian Pharmacy/Code 32 <OFF>



Italian Pharmacy/ Code 32 ON



B Check Digit Transmission

<Do Not Calculate Check Digit>



Calculate Check Digit & Transmit



Calculate Check Digit & Not Transmit



C Output Start/Stop Character

Enable



<Disable>



D Decode Asterisk

Enable



<Disable>



E Set Up Code Length

To set the fixed length:

1. Scan the "Begin" label of the desired set.
2. Go to the Decimal Value Tables in Appendix A, scan label(s) that represents the length to be read.
3. Scan the "Complete" label of the desired set. Repeat the steps 1 - 3 to set additional lengths.

<Variable>



Fix Length (2 Sets Available)

1. 1st Set Begin



2. Decimal Value (See Appendix A)

3. 1st Set Complete



1. 2nd Set Begin



2. Decimal Value (See Appendix A)

3. 2nd Set Complete



Minimum Length

1. Begin

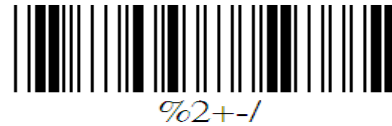

2. Decimal Value (See Appendix A)

3. Complete



6.4 Code 128 Parameters A Reading Type

UCC/EA1-128 Enable



<UCC/EA1-128 Disable>



<Enable']C1' Code Format>



Disable']C1' Code Format



<Enable Code128 Group Separators(GS)>



Disable Code128 Group Separators(GS)



B Check Digit Transmission

Do Not Calculate Check Digit



Calculate Check Digit & Transmit



<Calculate Check Digit& Not Transmit>



C Append FNC2

ON



<OFF>



D Set Up Code Length

To set the fixed length

1. Scan the "Begin" label of the desired set.
2. Go to the Decimal Value Tables in Appendix A scan label(s) that represents the length to be read.
3. Scan the "Complete" label of the desired set.
4. Repeat the steps 1 - 3 to set additional lengths.

<Variable>

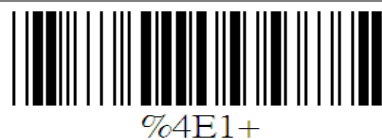

Fix Length (2 Sets Available)

1. 1st Set Begin



2. Decimal Value (See Appendix A)

3. 1st Set Complete



1. 2nd Set Begin



2. Decimal Value (See Appendix A)

3. 2nd Set Complete



Minimum Length

1. Begin

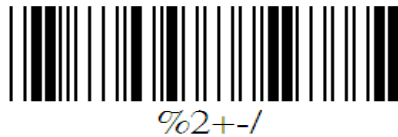

2. Decimal Value (See Appendix A)

3. Complete



6.5 Interleave 25 Parameters A Check Digit Transmission

<Do Not Calculate Check Digit>



Calculate Check Digit & Transmit



Calculate Check Digit & Not
Transmit



B Set Up Number of Character

<Even>



Odd



C Brazilian Banking Code

<Disable>



Enable



D Set 8p Code Length

To set the fixed length:

1. Scan the "Begin" label of the desired set.
2. Go to the Decimal Value Tables in Appendix A, scan label(s) that represents the length to be read.
3. Scan the "Complete" label of the desired set. Repeat the steps 1 - 3 to set additional lengths.

<Variable>



Fix Length (2 Sets Available)

1.1st Set Beg



2. Decimal Value (See Appendix A)

3. 1st Set Complete



1.2nd Set Begin



2. Decimal Value (See Appendix A)

3. 2nd Set Complete



Minimum Length

1. Begin

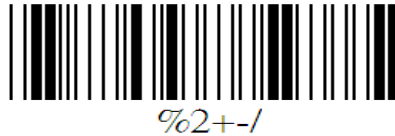

2. Decimal Value (See Appendix A)

3. Complete



6.6 Industrial 25 Parameters A Reading type

IATA25 Enable



<Disable>



B Check Digit Transmission

<Do Not Calculate Check Digit>



Calculate Check Digit & Transmit



Calculate Check Digit & Not Transmit



C Set Up Code Length

To set the fixed length

1. Scan the "Begin" label of the desired set.
2. Go the Decimal Value Tables in Appendix A, scan label(s) that represents the length to be read.
3. Scan the "Complete" label of the desired set.
4. Repeat the steps 1 - 3 to set additional lengths.

<Variable>

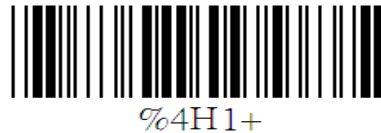

Fix Length (2 Sets Available)

1. 1st Set Begin



2. Decimal Value (See Appendix A)

3. 1st Set Complete



1. 2nd Set Begin



2. Decimal Value (See Appendix A)

3. 2nd Set Complete



Minimum Length

1. Begin

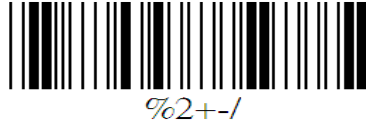

2. Decimal Value (See Appendix A)

3. Complete



6.7 Matrix 25 Parameters A Check Digit Transmission

<Do Not Calculate Check Digit>



Calculate Check Digit & Transmit



Calculate Check Digit & Not Transmit



B Set Up Code Length

To set the fixed length:

1. Scan the "Begin" label of the desired set.
2. Go to the Decimal Value Tables in Appendix A, scan label(s) that represents the length to be read.
3. Scan the "Complete" label of the desired set.
4. Repeat the steps 1 - 3 to set additional lengths.

<Variable>

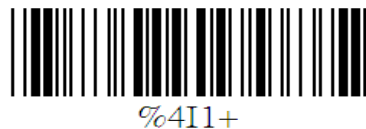

Fix Length (2 Sets Available)

1. 1st Set Begin



2. Decimal Value (Appendix A)

3. 1st Set Complete



1. 2nd Set Begin



2. Decimal Value (Appendix A)

3. 2nd Set Complete



Minimum Length

1. Begin

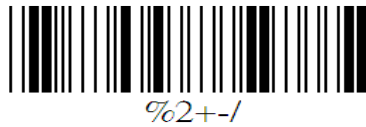

2. Decimal Value (Appendix A)

3. Complete



6.8 CODABAR/NW7 Parameters

A Set Up Start/Stop Characters Upon Transmission

ON



<OFF>



B Transmission Type of Start/Stop

<A/B/C/D> <Start>



<A/B/C/D> <Stop>



A Start



A Stop



B Start



B Stop



C Start



C Stop



D Start



D Stop



%04F8

C Set Up Code Length

To set the fixed length:

1. Scan the “Begin” label of the desired set.
 2. Go to the Decimal Value Tables in Appendix A, scan label(s) that represents the length to be read.
 3. Scan the “Complete” label of the desired set. Repeat the steps 1 - 3 to set additional lengths.
-

<Variable>

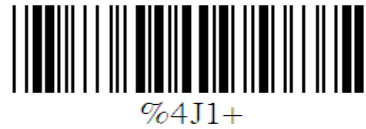

%4J1+

Fix Length (2 Sets Available)

1st Set Begin



%4J00

Decimal Value (Appendix A)

1st Set Complete



%4J01

2nd Set Begin



%4J00

**Decimal Value
(Appendix A)**

2nd Set Complete



%4J02

Minimum Length

Begin

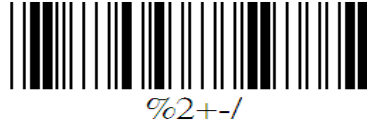

Decimal Value (Appendix A)

Complete



6.9 Code 93 Parameters

A Check Digit Transmission

<Calculate Check 2 Digits & Not Transmit>



Do Not Calculate Check Digit



B Set Up Code Length

To set the fixed length:

1. Scan the "Begin" label of the desired set.
2. Go to the Decimal Value Tables in Appendix A, scan label(s) that represents the length to be read.
3. Scan the "Complete" label of the desired set.
4. Repeat the steps 1 - 3 to set additional lengths.

<Variable>



Fix Length (2 Sets Available)

1st Set Begin



Decimal Value (Appendix A)

1st Set Complete



2nd Set Begin



Decimal Value (Appendix A)

2nd Set Complete



Minimum Length

Begin

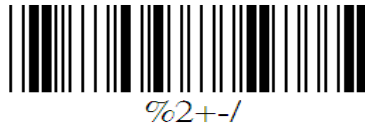

Decimal Value (Appendix A)

Complete



6.10 Code 11 Parameters

A Check Digit Transmission

<Do Not Calculate Check Digit>



Calculate Check 1 Digit & Transmit



Calculate Check 2 Digits & Not Transmit



Calculate Check 2 Digits & Transmit



Calculate Check 2 Digits & Not Transmit



B Set Up Code Length

To set the fixed length:

1. Scan the “Begin” label of the desired set.
2. Go to the Decimal Value Tables in Appendix A, scan label(s) that represents the length to be read.
3. Scan the “Complete” label of the desired set.
4. Repeat the steps 1 - 3 to set additional lengths.

<Variable>

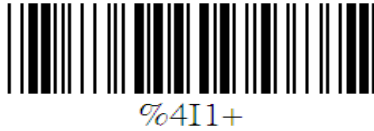

Fix Length (2 Sets Available)

1st Set Begin



Decimal Value (Appendix A)

1st Set Complete



2nd Set Begin



Decimal Value (Appendix A)

2nd Set Complete

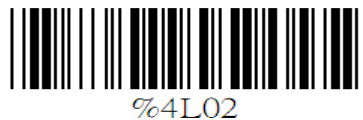

Minimum Length

Begin

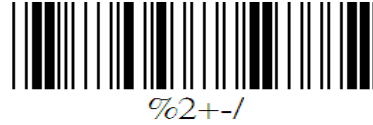

Decimal Value (Appendix A)

Complete



6.11 MSI/PLESSEY Code Parameters

A Check Digit Transmission

Do Not Calculate Check Digit



Calculate Check Digit & Transmit



<Calculate Check Digit & Not Transmit>



B Set Up Code Length

To set the fixed length:

1. Scan the "Begin" label of the desired set.
2. Go to the Decimal Value Tables in Appendix A, scan label(s) that represents the length to be read.
3. Scan the "Complete" label of the desired set.
4. Repeat the steps 1 - 3 to set additional lengths.

<Variable>

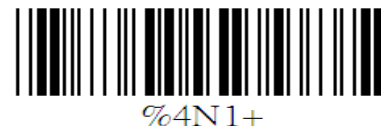

Fix Length (2 Sets Available)

1st Set Begin	 %4N00
Decimal Value (Appendix A)	
1st Set Complete	 %4N01
2nd Set Begin	 %4N00
Decimal Value (Appendix A)	
2nd Set Complete	 %4N02

Minimum Length

Begin	 %2+/-
Decimal Value (Appendix A)	
Complete	 %2C9+

6.12 LCD25 Parameters

A Check Digit Transmission

<Do Not Calculate Check Digit>	 %0QN3
Calculate Check Digit & Transmit	 %0QN7

Calculate Check Digit & Not Transmit



B Setup Code length

To set the fixed length:

1. Scan the “Begin” label of the desired set.
2. Go to the Decimal Value Tables in Appendix A, scan label(s) that represents the length to be read.
3. Scan the “Complete” label of the desired set.
4. Repeat the steps 1 - 3 to set additional lengths.

<Variable>

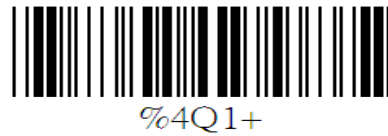

Fix Length (2 Sets Available)

1st Set Begin



Decimal Value (Appendix A)

1st Set Complete



2st Set Begin



Decimal Value (Appendix A)

2nt Set Complete



Minimum Length

Begin

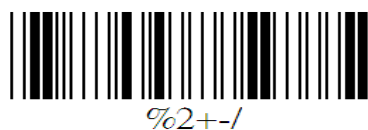

Decimal Value (Appendix A)

Complete



Fix Length (2 Sets Available)

1st Set Begin



Decimal Value (Appendix A)

1st Set Complete



2nd Set Begin



Decimal Value (Appendix A)

2nd Set Complete



Minimum Length

Begin



Decimal Value (Appendix A)

Complete



6.15 GS1 Databar

A GS1 DataBar Omnidirectional

<Transmit Check Digit>



Don't Transmit Check Digit



<Transmit Application ID>



Don't Transmit Application ID



Transmit Symbology ID



<Don't Transmit Symbology ID>



B GS1 DataBar Limited Parameters

<Transmit Check Digit>



Don't Transmit Check Digit



<Transmit Application ID>



Don't Transmit Application ID



Transmit Symbology ID



<Don't Transmit Symbology ID>



C GS1 DataBar Expanded Parameters

Transmit Symbology ID











<Don't Transmit Symbology ID>



Chapter 7 Miscellaneous Parameters

7.1 Language Selection

<US English>	 %0ZV0
UK English	 %0ZV1
Italian	 %0ZV2
Spanish	 %0ZV3
French	 %0ZV4
German	 %0ZV5
Swedish	 %0ZV6
Switzerland	 %0ZV7
Hungarian	 %0ZV8
Japanese	 %0ZV9

Belgium	 %0ZVA
Portuguese	 %0ZVB
Denmark	 %0ZVC
Netherlands	 %0ZVD
Turkey	 %0ZVE
Reserved2	 %0ZVF

7.2 Bar Code ID

ON	 %00H1
<OFF>	 %00H0
Default	 %913+

With this function ON, a leading character will be added to the output string while
Copyright 2012 unitech Electronics Co., Ltd. All rights reserved. Unitech is a registered trademark of unitech Electronics Co., Ltd.

scanning code, user may refer to the following table to know what kind of bar code is being scanned.

Please refer to the table below for matching code ID of codes read in.

Code Type	ID	Code Type	ID
UPC-A	A	UPC-E	E
EAN-8	FF	EAN-13	F
CODE 39	M	CODE 128	K
Interleave 25	I	Industrial 25	H
Matrix 25	I	Codabar/NW7	N
CODE 93	L	CODE 11	L
China Postage	C	MSI	O
LCD25	Q	PLESSEY	P
GS1 DataBar Omnidirectional	U	GS1 DataBar Expanded	W
GS1 DataBar Limited	V		

User Define Code ID

To set the code ID:

1. Scan the symbologies label.
2. Go to the ASCII Tables in Appendix B, scan label that represents the desired code ID.

Note:

User define code ID will override default value. Program will not check the conflict. It is possible to have more than two symbologies which have same code ID.

UPC-A



%91A+

UPC-E



%91B+

EAN-13/JAN-13



%91Y+

EAN-8/JAN-8	 %91Z+
CODE 39	 %91E+
CODE 128	 %91F+
CODABAR/NW7	 %91J+
Interleave 25	 %91G+
Industrial 25	 %91H+
Matrix 25	 %91I+
CODE 93	 %91K+
CODE 11	 %91L+
China Postage	 %91M+
MSI/PLESSEY	 %91N+

LCD25



%91Q+

GS1 DataBar Omnidirectional ON



%91U+

GS1 DataBar Limited ON



%91V+

GS1 DataBar Expanded ON



%91W+

Reserved5



%91R+

Reserved6



%91S+

7.3 Reading Level

Bar Equals High



%03I2

<Bar Equals Low>



%03I0

7.4 Accuracy

1 Time



%0130

2 Times



%0131

3 Times



4 Times



7.5 Buzzer Beep Tone

<High>



Medium



Low



Off



7.6 Sensitivity of Continuous Reading Mode

A Quick Setting:

<Fast>



Slow

B Same Code Delay Reading Interval

Following code sequences represent the length of time before a barcode can be rescanned at continuous and flash reading mode. The value can be defined from 1-50 and they represent 100ms to 5 seconds in 100ms interval. Default value is 3 (0.3 seconds).

To setup same code delay reading interval:

1. Scan the "Begin" label
2. Go the Decimal Value Tables in Appendix A, Scan label(s), that represents the same code delay reading interval. They are ranged form 1-50. One step is represented 0.1 second. So the interval is from 0.1 to 5 seconds.
3. Scan the "Complete" label
4. Repeat the steps 1-3 to set time out of same symbol

Begin



Decimal Value (1-50) (Appendix A)

Complete



7.7 Reverse Output Characters

<Disable>



Enable



7.8 Setup Deletion

To setup the deletion of output characters:

1. Scan the label of the desired set below.
2. Scan the label of the desired symbology.
3. Go to the Decimal Value Tables listed in Appendix A, scan labels that represents the desired position to be deleted.
4. Scan "Complete" label of "Character Position to be Deleted".
5. Go to the Decimal Value Tables in appendix A, scan labels that represents the desired position to be deleted.
6. Scan the "Complete" label of "Number Position to be Deleted".
7. Repeat the steps 1 – 6 to set additional deletion.









A. Select Deletion Set Number

1st Set	 %800+
2nd Set	 %801+
3rd Set	 %802+
4th Set	 %803+
5th Set	 %804+
6th Set	 %805+

B Symbology Selection

UPC-A	 %81A+
UPC-E	 %81B+
EAN-13/JAN-13/ISBN-13	 %81Y+

EAN-8/JAN-8	 %81Z+
CODE 39	 %81E+
CODE 128	 %81F+
CODABAR/N97	 %81J+
Interleave 25	 %81G+
Industrial 25	 %81H+
Matrix 25	 %81I+
CODE 93	 %81K+
CODE 11	 %81L+
China Postage	 %81M+
MSI/PLESSEY	 %81N+

LCD25	 %81Q+
GS1 DataBar Omnidirectional	 %81U+
GS1 DataBar Limited	 %81V+
GS1 DataBar Expanded	 %81W+
All Codes	 %81S+
None	 %814+
C Character Position to be Deleted	
1. Decimal Value (Appendix A)	
2. Complete	 %820+
D Number of Characters to be Deleted	
1. Decimal Value (Appendix A)	
2. Complete	 %830+

7.9 Setup Insertion











To setup the insertion of output characters

1. Scan the label of the desired set.
2. Scan the label of the desired symbology.
3. Go to the Decimal Value Tables in Appendix A, scan label(s) that represents the desired position to be inserted.
4. Scan the "Complete" label of "Character Position to be Inserted".
5. Go to the ASCII Tables in Appendix B or Function Key Tables in Appendix C, scan label(s) that represents the desired characters to be inserted.
6. Scan the "Complete" label of "Characters to be Inserted".
7. Repeat the steps 1 - 6 to set additional insertion.

A Select Insertion Set Number

1st Set	 %500+
2nd Set	 %501+
3rd Set	 %502+
4th Set	 %503+
5th Set	 %504+
6th Set	 %505+

B Symbologies Selection

UPC-A	 <i>%51A+</i>
UPC-E	 <i>%51B+</i>
EAN-13/JAN-13/ISBN-13	 <i>%51Y+</i>
EAN-8/JAN-8	 <i>%51Z+</i>
CODE 39	 <i>%51E+</i>
CODE 128	 <i>%51F+</i>
CODABAR/NW7	 <i>%51J+</i>
Interleave 25	 <i>%51G+</i>
Industrial 25	 <i>%51H+</i>
Matrix 25	 <i>%51I+</i>
CODE 93	 <i>%51K+</i>

CODE 11	 %51L+
China Postage	 %51M+
MSI/PLESSEY	 %51N+
LCD255	 %51Q+
GS1 DataBar Omnidirectional	 %51U+
GS1 DataBar Limited	 %51V+
GS1 DataBar Expanded	 %51W+
All Codes	 %51S+
None	 %514+
C Character Position to be Inserted	
Decimal Value (Appendix A)	
Complete	 %520+

D Characters to be Inserted

ASCII Table (Appendix B)

Complete











































%530+

Appendix A Decimal Value Table

0		5	
1		6	
2		7	
3		8	
4		9	

Appendix B ASCII Table























NULL		STX		SOH	
ETX		ENQ		EOT	
ACK		BS		BEL	
HT		VT		LF	
FF		SO		CR	
SI		DC1		DLE	

DC2		DC4		DC3	
	12		14		13
NAK		ETB		SYN	
	15		17		16
CAN		SUB		EM	
	18		1A		19
ESC		GS		FS	
	1B		1D		1C
RS				US	
	1E				1F
SPACE		“		!	
	20		22		21
#		%		\$	
	23		25		24
&		(	‘	
	26		28		27
)		+		*	
	29		2B		2A
,		.		-	
	2C		2E		2D
/		1		0	
	2F		31		30
2		4		3	
	32		34		33
5		7		6	
	35		37		36
8		:		9	
	38		3A		39
;		=		<	
	3B		3D		3C
>				?	
	3E				3F

@	40	B	42	A	41
C	43	E	45	D	44
F	46	H	48	G	47
I	49	K	4B	J	4A
L	4C	N	4E	M	4D
O	4F	Q	51	P	50
R	52	T	54	S	53
U	55	W	57	V	56
X	58	Z	5A	Y	59
[5B]	5D	\	5C
^	5E	_	5F		
`	60	b	62	a	61
c	63	e	65	d	64
f	66	h	68	g	67
i	69	k	6B	j	6A

l	 6C	n	 6E	M	 6D
o	 6F	q	 71	p	 70
r	 72	t	 74	s	 73
u	 75	w	 77	v	 76
x	 78	z	 7A	y	 79
{	 7B	}	 7D		 7C
~	 7E			DEL	 7F

Appendix C Function Key Table

F1	 C0	F3	 C2	F2	 C1
F4	 C3	F6	 C5	F5	 C4
F7	 C6	F9	 C8	F8	 C7
F10	 C9	F12	 CB	F11	 CA
Insert	 CC	Home	 CE	Delete	 CD
Page Up	 CF	End	 D1	Page Down	 D0
Left	 D2	Up	 D4	Right	 D3
Down	 D5				

8 SPECIFICATION

8.1 Dimensions

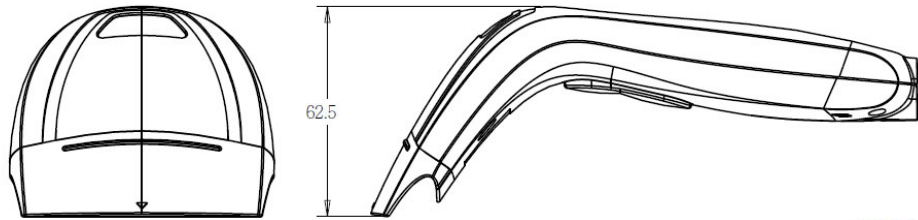
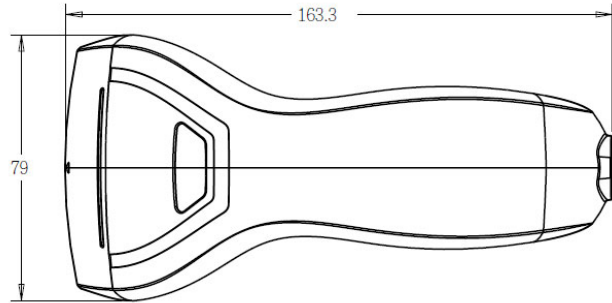

MS-250
UNIT:mm

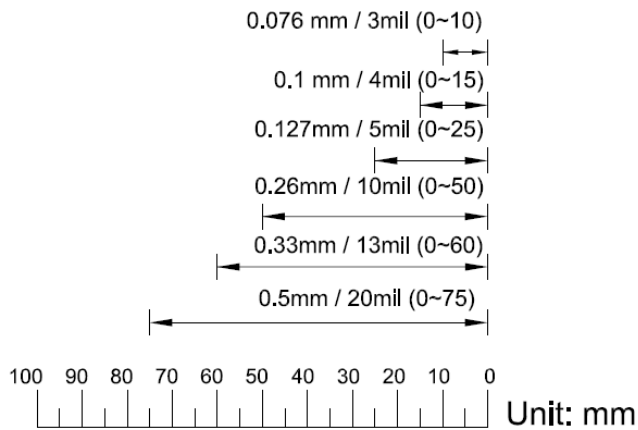
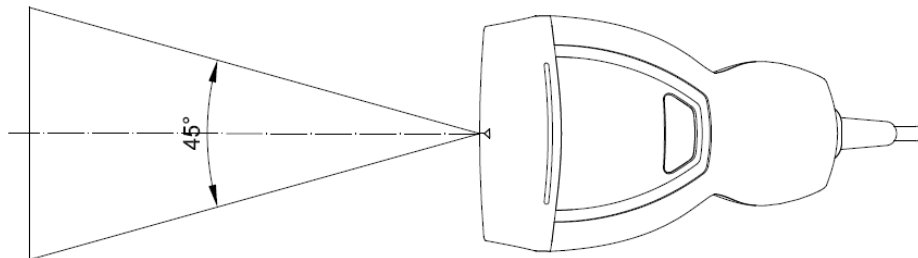

8.2 Technical Data

Interface	USB
Supply Voltage	DC +5V \pm 10%
Output Voltage (Typ.)	+5V
Output low Voltage (Max.)	0.4V
Current Draw (Typ.)	\pm 5%
Power On (Typ.)	120mA
Stand by (Typ.)	20mA
Operation (Typ.)	120mA
Light Source	Visible Red light 635nm LED
Sensor	Linear CCD Sensor
Processor Type	ARM Cortex™-M3, 32-bit
Operating Freq.	8 MHz (Internal)
Scan Speed	200 scans/ second \pm 10%
Depth of Field	Up to 75mm @ 20mil, PCS90%, Code39
Width of Field (Window)	80 mm
Print Contrast Ratio	45%
Resolution	3mil (0.076mm) @ PCS90%
Ambient Light	20,000 Lux Max
Reading Angle	<i>Test Conditions : Code 39, 10mil/0.25mm, PCS 90%</i>
Forward & Backward	\pm 10°~30° (\pm 5°)
Left & Right	\pm 60° (\pm 5°)
Firmware	Available for updated
Driver	Support USB emulation COM port
ESD	8kv contact, 12kv on air
Bit error rate	50/100,000
Operating Temperature	0 °C to 50 °C (32 °F to 122 °F)
Storage Temperature	-20 °C to 70 °C (-4 °F to 158 °F)
Relative Humidity	20% to 95% (Non-condensing)

8.3. Readable Symbology

	Readable	Default Enable
All UPC/EAN/JAN	V	V
EAN128 Code	V	V
Code 39	V	V
Code 39 Full ASCII	V	
Code32 / Italian Pharmacy	V	
Code 128	V	V
CODABAR/NW7	V	V
Interleave 25	V	V
Industrial 25	V	
Matrix 25	V	
MSI/PLESSEY	V	
Code 93	V	
Code 11	V	
China Postage	V	
LCD25	V	
GS1 DataBar Omnidirectional	V	
GS1 DataBar Turncated	V	
GS1 DataBar Stacked	V	
GS1 DataBar Omnidirectional Stacked	V	
GS1 DataBar Limited	V	
GS1 DataBar Expanded	V	
GS1 DataBar Expanded Stacked	V	

8.4. Reliability

Life Time	
Trigger Switch	1,000,000 times
MTBF(Calculated)	50,000 hours
Thermal Shock	
High Temp.	60 °C (140 °F)
Low Temp.	-20 °C (-4 °F)
Cycle time	20 minutes for high temp. , 20 minutes for low temp.
Cycles	5 cycles
Cable Bending Test	25,000 times/ minimum (30 times/ min @ 500g/ 90 °)
Drop	59.06 inches (150cm) drop on Concrete Surface
Beeper	90 db/ minimum