

BIXOLON®

User's Manual

SRP-S320

LINERLESS PRINTER

Ver. 2.00



www.bixolon.com

Copyright

© BIXOLON Co., Ltd. All rights reserved.

This user manual and all property of the product are protected under copyright law. It is strictly prohibited to copy, store, and transmit the whole or any part of the manual and any property of the product without the prior written approval of BIXOLON Co., Ltd. The information contained herein is designed only for use with this BIXOLON product. BIXOLON is not responsible for any direct or indirect damages, arising from or related to use of this information.

- The BIXOLON logo is the registered trademark of BIXOLON Co., Ltd.
- All other brand or product names are trademarks of their respective companies or organizations.

BIXOLON maintains ongoing efforts to enhance and upgrade the functions and quality of all our products.

In the following, product specifications and/or user manual content may be changed without prior notice.

Caution

Electronics, such as printers, are prone to damage by static electricity. Therefore, to protect the printer from static electricity, be sure to turn off the printer before connecting or disconnecting the cable to the rear of the printer. If the printer is damaged by static electricity, contact your local dealer.

This equipment is not suitable for use in locations where children are likely to be present.

When the printer is operating with the media cover open, do not wear anything that can touch the drive, such as clothing, necklaces, rings, watches, or employee certificates close to it. Also, keep yourself away from the printer as it is dangerous for some parts of the body to come into contact with it. If an object or part of your body touches the drive, immediately disconnect the power cord or turn off the power switch on the back of the product.

Warning

Hazardous moving parts

Keep fingers and other body parts away

Pull the print head lever can be stop all moving parts.



IEC 60417-6057 (2011-05) for other moving parts.

Mise en garde

Les appareils électroniques, tels que les imprimantes, risquent d'être endommagés par l'électricité statique. Par conséquent, pour protéger l'imprimante de l'électricité statique, veuillez à l'éteindre avant de connecter ou de déconnecter le câble situé à l'arrière de celle-ci. Si l'imprimante est endommagée par l'électricité statique, contactez votre revendeur local

Cet appareil n'est pas adapté d'utiliser dans des endroits où des enfants sont probablement d'être présents.

Lorsque l'imprimante fonctionne avec le capot ouvert, ne portez rien qui puisse entrer en contact avec le mécanisme, tel que des vêtements, des colliers, des bagues, des montres ou des certificats d'employé à proximité. Éloignez-vous également de l'imprimante car il est dangereux que certaines parties du corps entrent en contact avec celle-ci. Si un objet ou une partie de votre corps entre en contact avec le mécanisme, débranchez immédiatement le câble d'alimentation ou éteignez l'interrupteur situé à l'arrière du produit.

Attention

Pièces mobiles dangereuses

Veillez à ce que vos doigts ou toute partie du corps n'entre(nt) pas en contact avec ces pièces. Tirez le levier de la tête d'impression pour arrêter toutes les pièces en mouvement.



IEC 60417-6057 (2011-05) pour les autres pièces mobiles.

Compliance information

This device complies with Part 15 of the FCC Rules. Operation is subject to the following two conditions: (1) This device may not cause harmful interference, and (2) This device must accept any interference received, including interference that may cause undesired operation.

This equipment has been tested and found to comply with the limits for a Class A digital device pursuant to Part 15 of the FCC Rules. These limits are designed to provide reasonable protection against harmful interference when the equipment is operated in a commercial environment. This equipment generates uses, and can radiate radio frequency energy and, if not installed and used in accordance with the instruction manual, may cause harmful interference to radio communications. Operation of this equipment in a residential area is likely to cause harmful interference in which case the user will be required to correct the interference at his own expense.

Caution: Exposure to Radio Frequency Radiation.

To comply with FCC RF exposure compliance requirements, a separation distance of at least 20 cm must be maintained between the antenna of this device and all persons.

Caution: Any Changes or modifications not expressly approved by the manufacturer could void the user's authority to operate the equipment.

Class A Digital Device: Wired Device

This Apparatus complies with class "A" limits for radio interference as specified in the Canadian department of communications radio interference regulations.

This Class A digital apparatus complies with Canadian ICES-003.

Appareil numérique de classe A: appareil filaire

Get appareil est conforme aux normes class "A" d'interference radio tel que specifier par ministre canadien des communications dans les reglements d'interference radio.

Cet appareil numérique de la classe A est conform à la norme NMB-003 du Canada.

Waste Electrical and Electric Equipment (WEEE)



This marking shown on the product or its literature, indicates that it should not be disposed with other household wastes at the end of its working life, to prevent possible harm to the environment or human health from uncontrolled waste disposal, please separate this from other types of wastes and recycle it responsibly to promote the sustainable reuse of material resources. Household users should contact either the retailer where they purchased this product, or their local government office, for details of where and how they can take this item for environmentally safe recycling. Business users should contact their supplier and check the terms and conditions of the purchase contract. This product should not be mixed with other commercial wastes for disposal.



WARNING & CAUTION

Is described as death, physical injuries, serious financial losses, and damage to data etc. that can be caused to the user.

Do not connect multiple products to a single or faulty power outlet. Use only grounded power outlets that meet the industry standard. **Noncompliance may cause electric shock or fire.**



Only use authentic products from BIXOLON. **The company will not provide post-sale support for damaged or other quality issues that any fake (or refurbished) products may incur.**



Do not excessively bend or strain the power cord. Securely push the power cord all the way into the power outlet lest it remain loose. Make sure to hold the cord tight when separating it from the power outlet. Do not remove the power cord while the product is in use. **Noncompliance may cause electric shock or fire.**



Keep small accessories or other packaging materials away from young children. Beware: choking hazard. **Mishandling the product may incur injuries which may require seeking urgent medical attention.**



Keep excessive liquids away from the power cord and outlet. If matter is smeared onto the power cords, wipe with a dry cloth. **Noncompliance may cause electric shock or fire.**

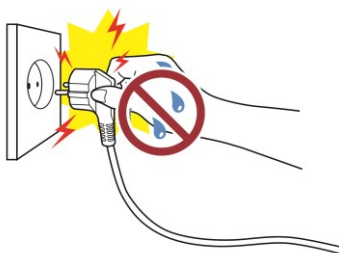

Do not allow the product to be damaged by heavy objects. **Noncompliance may cause electric shock or fire.**

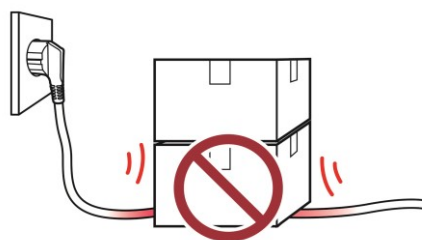

If the product emits a strange sound, burning smell, or smoke, turn off the power immediately and unplug the power cord. If the product is dropped or its exterior is damaged, turn off the power immediately and unplug the power cord. Do not subject the product to shock. **It may start a fire. It may damage the product.**

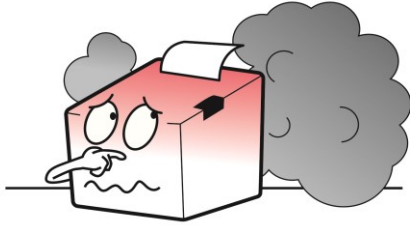

Install the product in a well-ventilated area by keeping it a certain distance from the wall. The product installed in certain places such as where a lot of fine dust is generated, where the temperature is too high or too low, where there is a lot of moisture or water, and at airports or stations that are used continuously for a long time may suffer serious quality problems due to the influence of the surrounding environment. **An increase in internal temperature may start a fire. Be sure to contact the place of purchase before installing the product.**

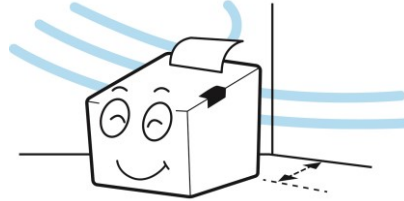

Install the product in a fixed place preventing it from tipping over. When moving the product, turn off the power and disconnect all connected cables, including the power cord. **It may damage the product.**



Never independently disassemble, repair, or modify the product as the warranty will become invalid. **When repair is necessary, contact the original place of purchase.**

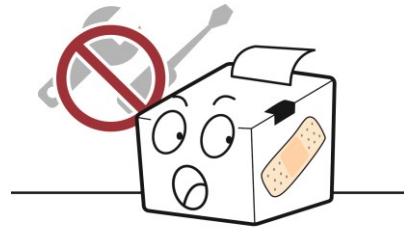

Do not let any foreign substances enter the product. Do not place heavy objects, liquids, or metals on the product. **This could cause damage to the product or a fire.**



If there is a problem with the product, please contact the original place of purchase or through BIXOLON website's product repair page (www.bixelon.com).

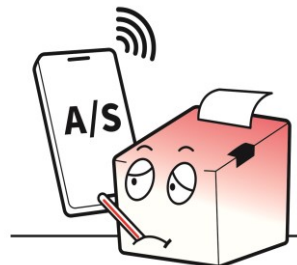

Manual Introduction

This manual provides basic information on printers and provides ways to install, use, and check them. In order to protect the safety of users and prevent property damage, be fully familiar with this manual before using the product. Please use it.

Manual Symbol Introduction

	Precaution & Warning	It describes death, physical injuries, serious financial losses, and damage to data etc. that can be caused to the user.
	Note	It provides additional information on the function and performance of the product.

Product Symbol Introduction

	DC (Direct current)
	Error, Warning
	Paper Feeding
	Stand-By
	USB
	Ethernet

Printer Introduction

Equipped with silicone-coated Platen Roller featuring embossed surface, the 3-inch Linerless printer SRP-S320 is specifically designed for Linerless media with extreme level of adhesion. Offering large media roll capacity of up to 120 mm the SRP-S320 produces 203 dpi linerless labels at 150 mm/sec. Providing 4 media width options including 40 / 58 / 62 / 80 mm.

The main features of the printer are as follows

1. LINERLESS PRINTER
2. Low-noise thermal transfer method printing
3. Maximum 150mm/s printing speed
4. 156 x 227 x 161 (W X D X H)
5. Interface: USB & Ethernet (Built-in), Serial, Wireless LAN Dual, Bluetooth 5.2, B-gate(HUB)
6. Equipped with data buffer (receives print data even while printing)
7. Can print a range of barcodes
8. Range of printing density selectable
(Controlled with virtual memory switch management)

Table of Contents

Copyright.....	2
WARNING & CAUTION	6
Manual Introduction	8
Printer Introduction	9
1. Content Confirmation	11
2. Product Part Names	12
2-1 Printer Part Names	12
2-2 Interface Part Names	13
2-2-1 USB (Built-in).....	13
2-2-2 Ethernet (Built-in).....	14
2-2-3 Single Serial Interface Card (RS-232C)	15
2-2-4 Wireless LAN Interface Card	16
2-2-5 Bluetooth Interface Card	17
2-2-6 B-gate Interface Card.....	18
3. Installation & Usage	20
3-1 Printer Installation Placings	20
3-2 Turn on the power	21
3-3 Inserting and changing the paper roll	23
3-4 Using Controller.....	26
3-5 Mounting Partition	27
3-6 Setting Volume.....	28
3-7 Taken Sensor Function.....	29
4. Printer Setting Change	30
5. Self-Test	31
6. Hexadecimal Dumping	34
7. Maintenance	35
7-1 Paper Jam.....	35
7-2 Cleaning Printer	36
8. Specifications	37
8-1 Printer Specifications.....	37
8-2 Recommended Papers	38

1. Content Confirmation



- If there is any part missing, please contact the place of purchase.
- The actual part may look different from the image.

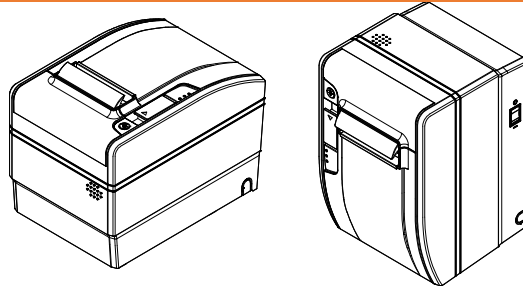

SRP-S320

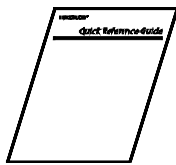

Installation Guide

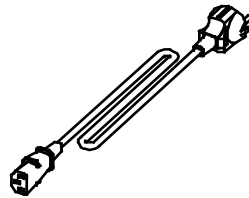

Power cord

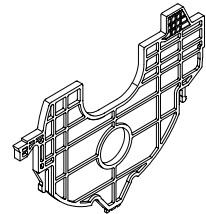

Partition 2ea

2. Product Part Names

2-1 Printer Part Names

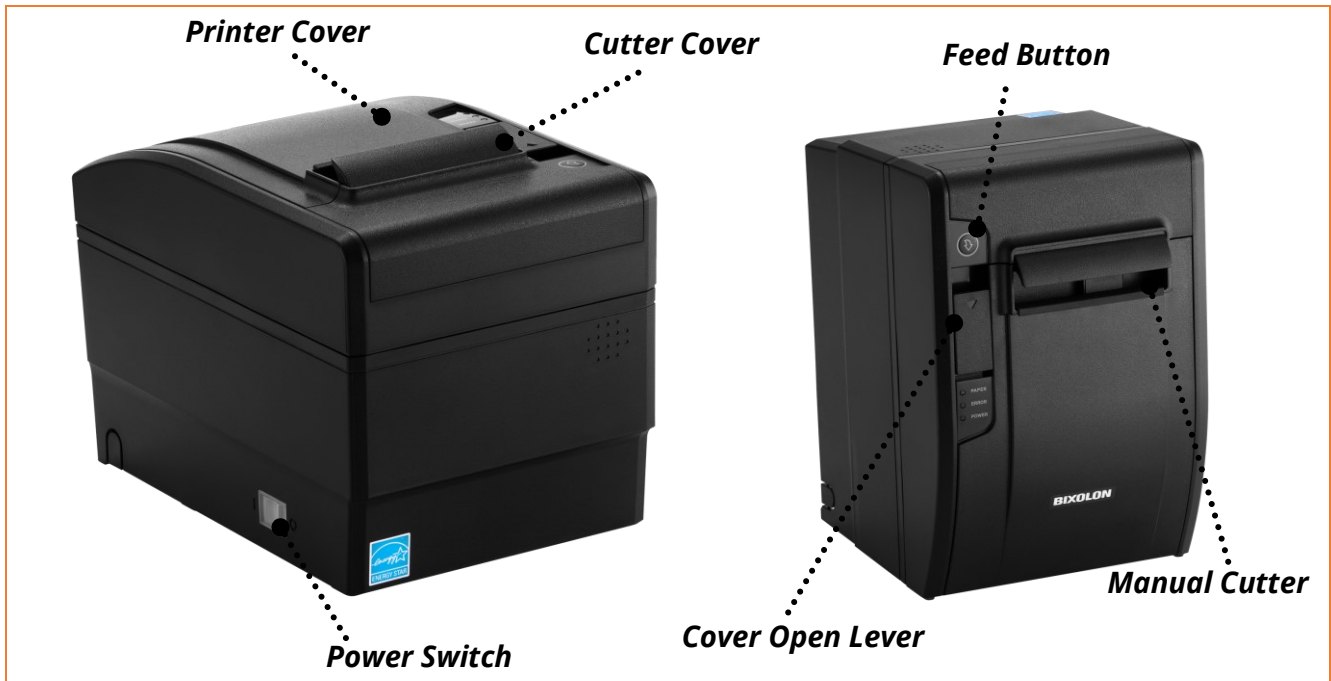

2-2 Interface Part Names

- Connect the printer to the host computer using the right interface cable that complies with the specifications of the interface.

2-2-1 USB (Built-in)

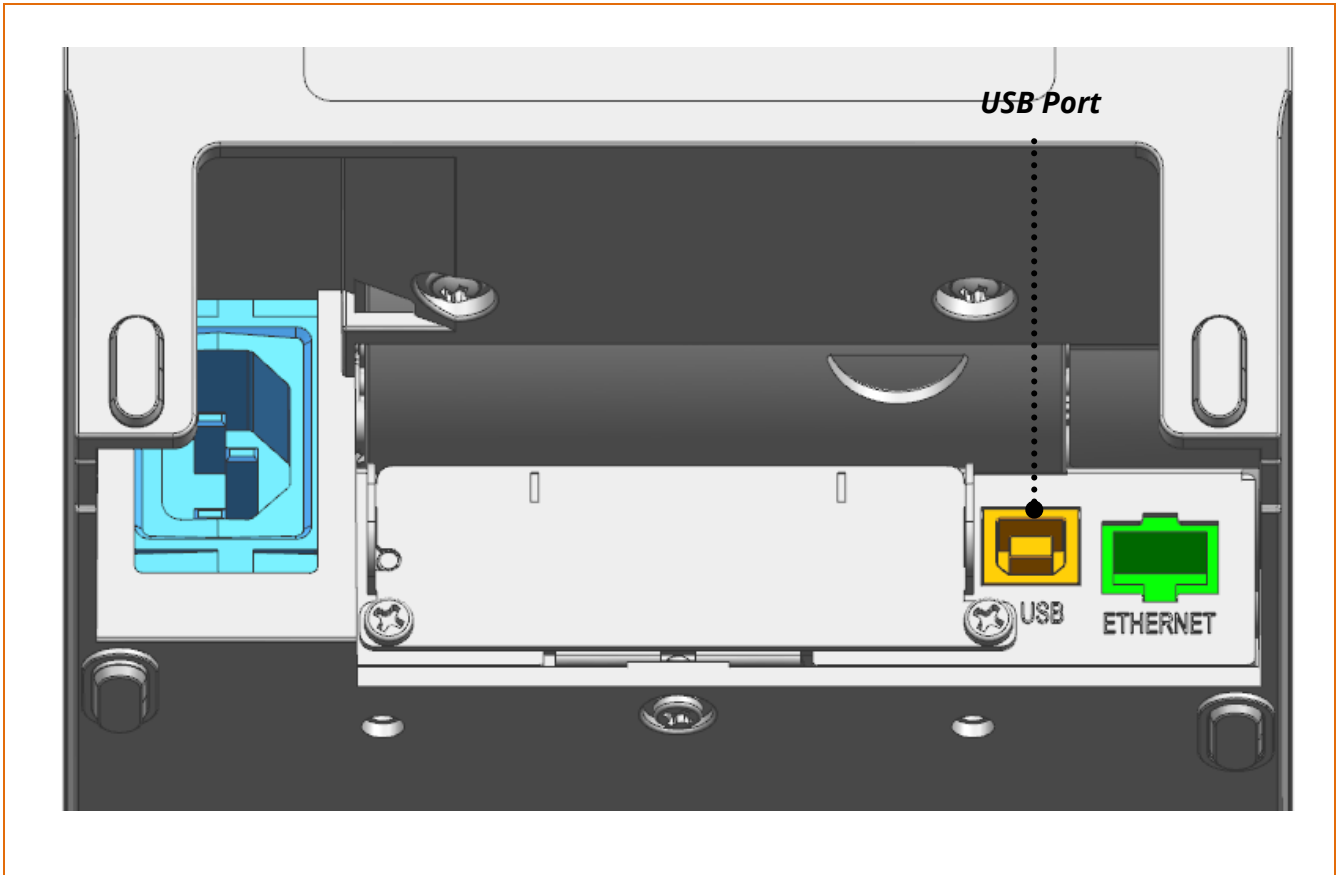

Pin No.	Signal Name	Designation (Color)	Function
Shell	Shield	Drain Cable	Frame Ground
1	VBUS	RED	Host Power
2	D-	WHITE	Data Line (D-)
3	D+	GREEN	Data Line (D+)
4	GND	BLACK	Signal Ground



Connect or disconnect the communication cable while the printer power is off. If power is on, your data may be lost.

2-2-2 Ethernet (Built-in)

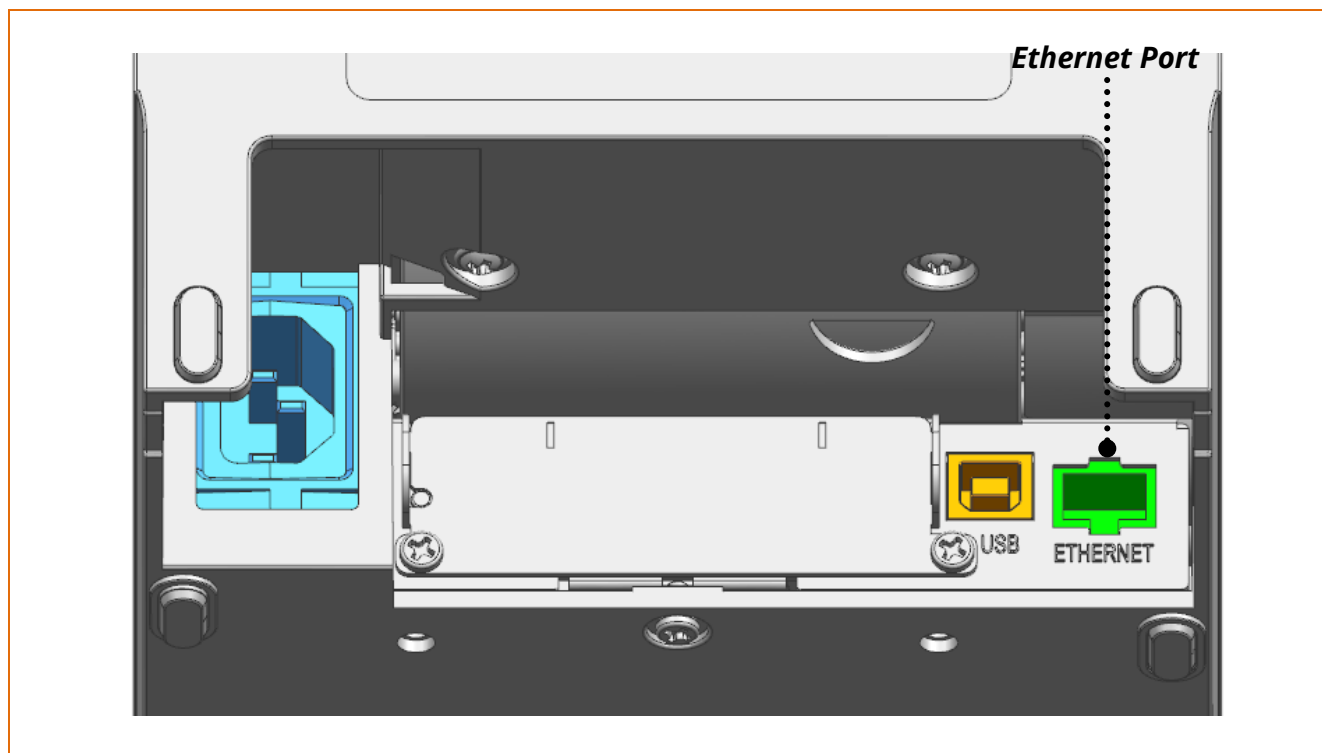

Pin No.	Signal Name	Designation (Color)	Function
1	TD+	WHITE ORANGE	Transmit +
2	TD-	ORANGE	Transmit -
3	CT	WHITE GREEN	Center tap
4	NC	BLUE	-
5	NC	WHITE BLUE	-
6	NC	GREEN	-
7	RD+	WHITE BROWN	Receive +
8	RD-	BROWN	Receive -



Connect or disconnect the communication cable while the printer power is off. If power is on, your data may be lost.



- Information such as IP and Mac can be found by operating the function key.
- Refer to the utility and network connection manual for Interface connection information. (www.bixolon.com)

2-2-3 Single Serial Interface Card (RS-232C)

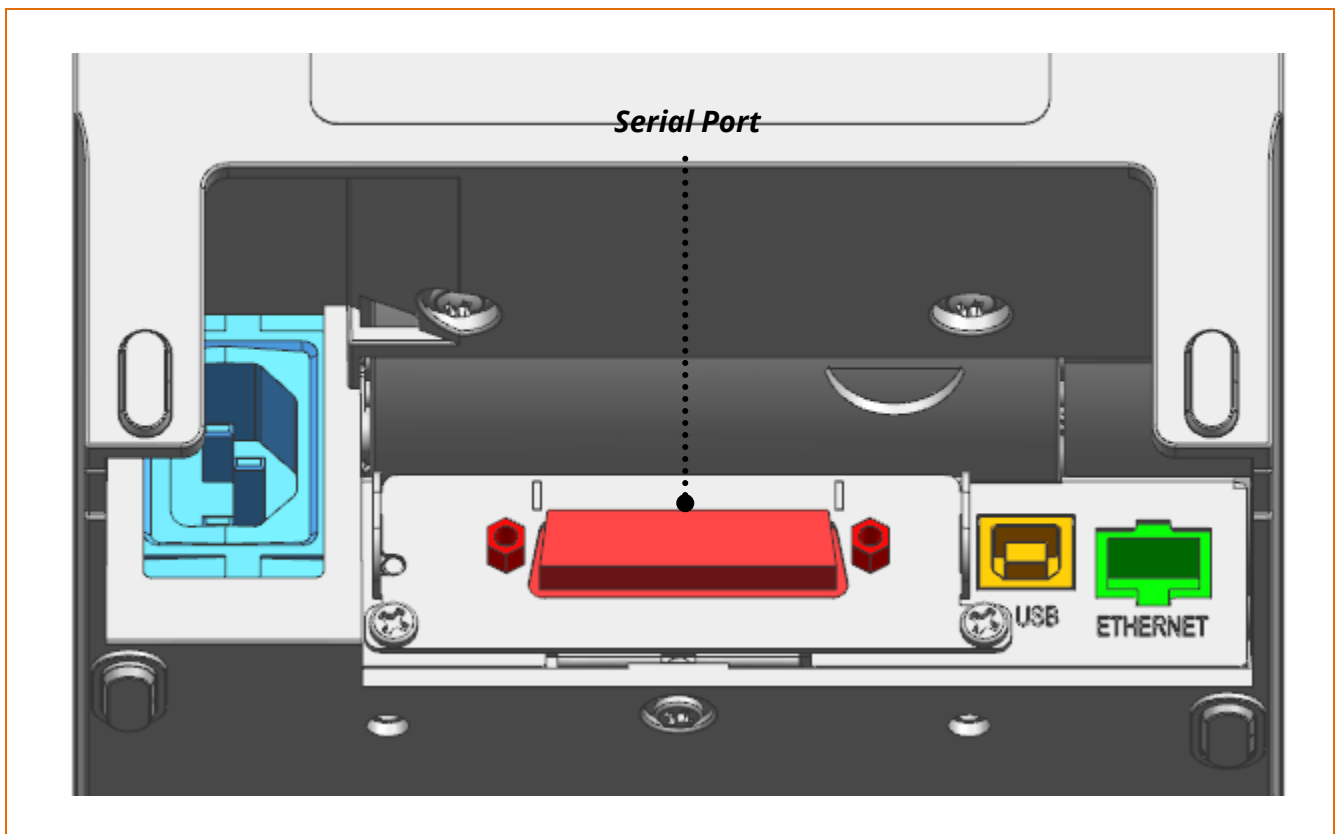

Pin No.	Signal Name	Direction	Function
1	FG	-	Frame Ground
2	TxD	Output	Transmit Data
3	RxD	Input	Receive Data
4	RTS	Output	Ready To Send
6	CTS	Input	Clear To Send
7	SG	-	Signal Ground
20	DTR	Output	Data Terminal Ready



Connect or disconnect the communication cable while the printer power is off. If power is on, your data may be lost.

2-2-4 Wireless LAN Interface Card

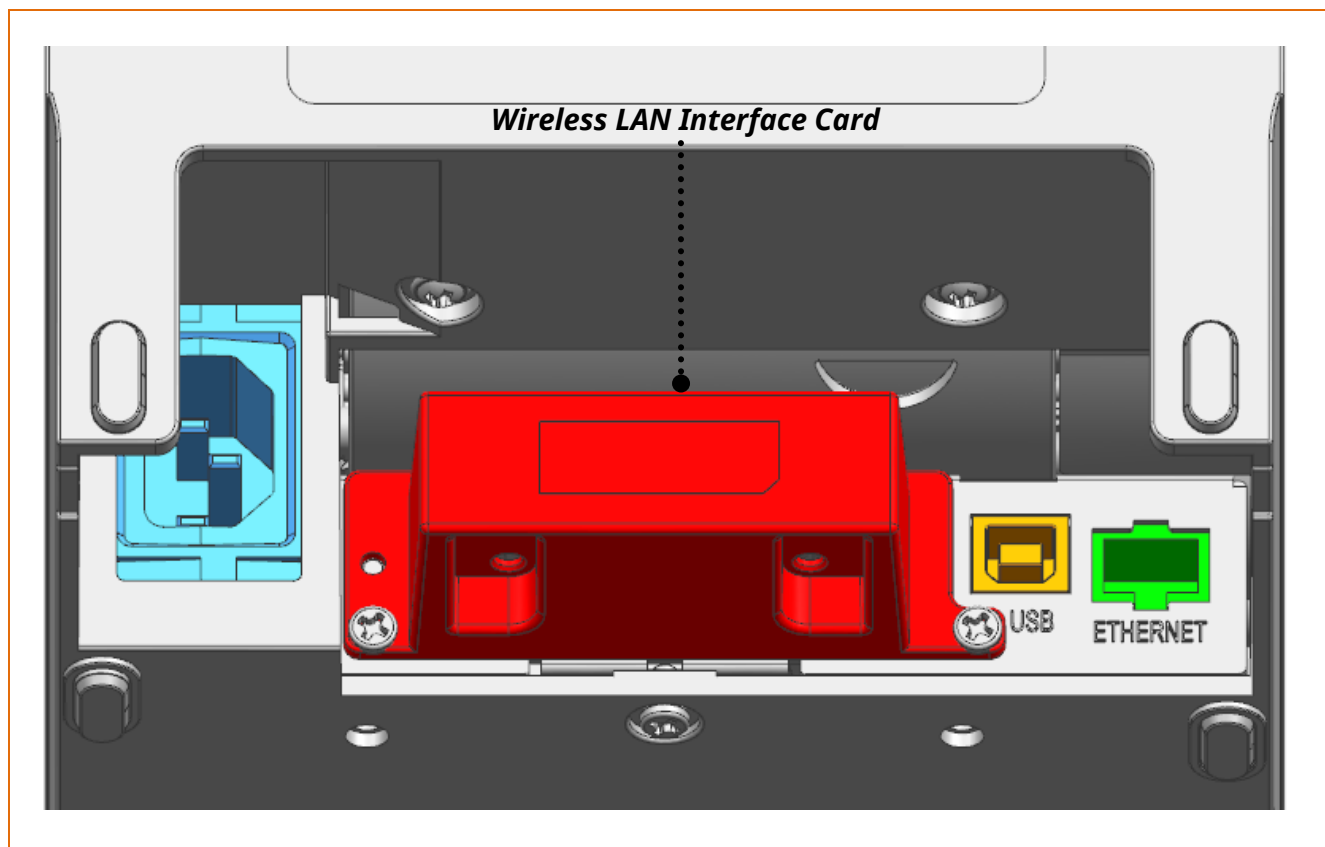

1) Wireless LAN Communication Specifications

Item	Specifications
Frequency	2.4GHz / 5GHz
Protocol	802.11 a/b/g/n

2) Connecting Wireless LAN

Printer can be connected to terminal devices with wireless LAN communication capability. (PDA, PC, smartphone, tablet PC, etc.).



Refer to the Network Connection Manual for more detailed instructions about how to establish the connection. The Network connection manual is on the BIXOLON website (www.bixolon.com) We're offering it.

2-2-5 Bluetooth Interface Card

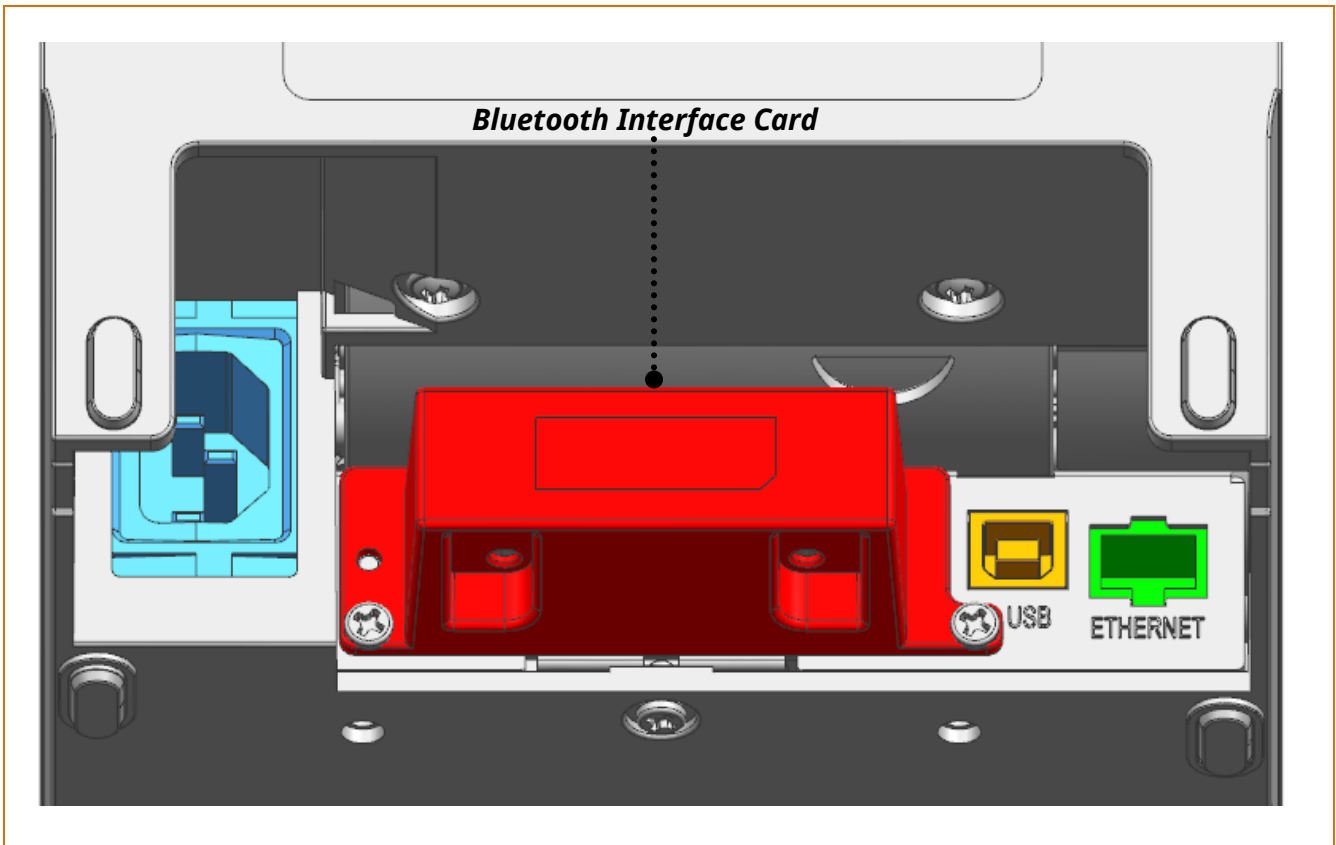

1) Bluetooth Communication Specifications

Item	Specifications
Frequency	2.402~2.480 GHz
Version	5.2

2) Bluetooth Connection

Printer can be connected to terminal devices with Bluetooth communication capability. (PDA, PC, smartphone, tablet PC, etc.)



Refer to the Bluetooth Connection Manual for more detailed instructions about how to establish the connection. The Bluetooth Connection manual is on the BIXOLON website (www.bixolon.com) We're offering it.

2-2-6 B-gate Interface Card

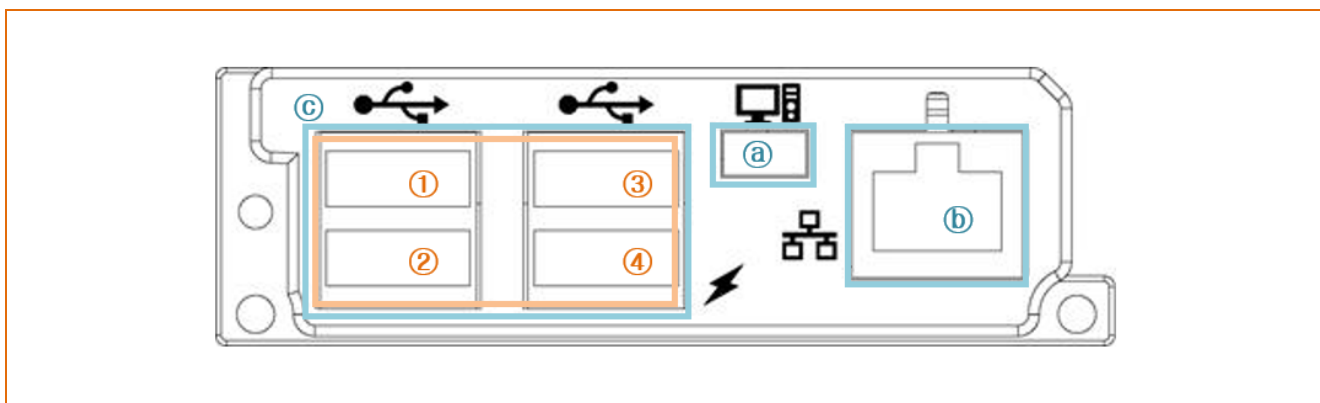

USB A type: ①②③④

Pin No.	Signal Name	Designation (Color)	Function
Shell	Shield	Drain Cable	Frame Ground
1	VBUS	RED	Host Power
2	D-	WHITE	Data Line (D-)
3	D+	GREEN	Data Line (D+)
4	GND	BLACK	Signal Ground

Ethernet: ⑥

Pin No.	Signal Name	Designation (Color)	Function
1	TD+	WHITE ORANGE	Transmit +
2	TD-	ORANGE	Transmit -
3	CT	WHITE GREEN	Center tap
4	NC	BLUE	-
5	NC	WHITE BLUE	-
6	NC	GREEN	-
7	RD+	WHITE BROWN	Receive +
8	RD-	BROWN	Receive -

USB Mini TYPE: ①

Pin No.	Signal Name	Designation (Color)	Function
Shell	Shield	Drain Cable	Frame Ground
1	VBUS	RED	Host Power
2	D-	WHITE	Data Line (D-)
3	D+	GREEN	Data Line (D+)
4,5	GND	BLACK	Signal Ground



- USB A connectors ①② can be used to connect the printer to supported peripheral devices.
- USB A connector ③ and USB Mini-B connector cannot be used at the same time. Please use only one of them.
- USB A connector ④ can be used to connect the printer to supported peripheral devices and supports battery charging. (supports max. 5V/2A)
- Using USB A connector ④ and USB Mini-B connector ① at the same time, disables USB A connector ④.
- Switch off the printer when connecting or disconnecting communication cables.

3. Installation & Usage

3-1 Printer Installation Placings

- Allow sufficient space around the printer for proper ventilation.
- Do not place objects close to the back or bottom of the printer, which may hinder the air circulation.
- Install the printer on a flat and level surface.
- Avoid humid environment.
- Install in a place that does not exceed the protocol standard of the wireless communication or the specified maximum distance.
- For stable wireless communication, install in a place where there is no physical obstacle (wall, object, etc.).

3-2 Turn on the power

1) After turning the printer off, connect the power cord jack to the printer's power port.

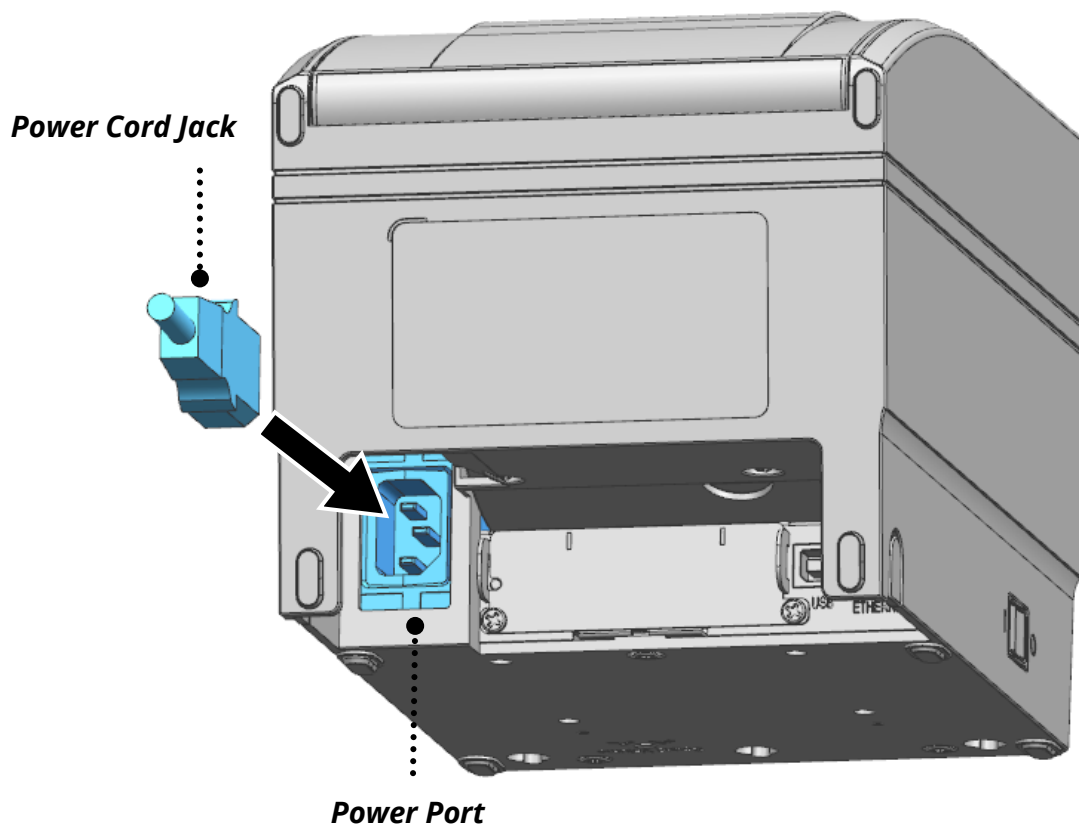

2) Plug it into the power outlet on the wall.

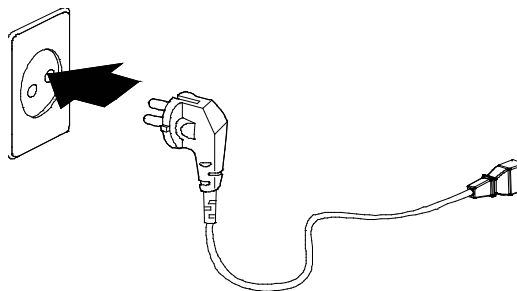

3) Press the "ON" switch to turn on the printer.



- Check the power supply's label to check its electronic specs.
- Only use a power supply provided by BIXOLON. BIXOLON shall bear no responsibility for damage caused by using a third-party power supply.
- When removing the power supply, make sure you have a firm grasp of the plug terminal of the power jack and the printer and pull horizontally.
- When connecting or disconnecting power, make sure to remove the power supply from the power outlet before removing.
- Pay attention to the direction in which you insert the power cord.
- Do not connect a voltage out of the specifications of the power supply. It can cause damage to the product or a fire.

3-3 Inserting and changing the paper roll

Use paper roll that complies with the specifications

If you use a paper roll including paper core attached to paper, the paper may not be properly recognized as paper Empty due to not proper releasing of paper.



- **When opening or closing the cover, be careful not to pinch your fingers.**

- **Do not open the print head levers while the printer is printing. The printer may be damaged.**

- **Change the paper when the printer is not receiving data, or data may be lost.**

- **While the printer is operating, the printer head gets very hot, so turn off the power and let it cool down completely.**

The hot printer head can cause serious burns.

1) Open the paper roll cover by Pulling the Cover-Open Lever.



When you change the paper, remove the used paper roll.

2) Replace with a new one as shown in the image.

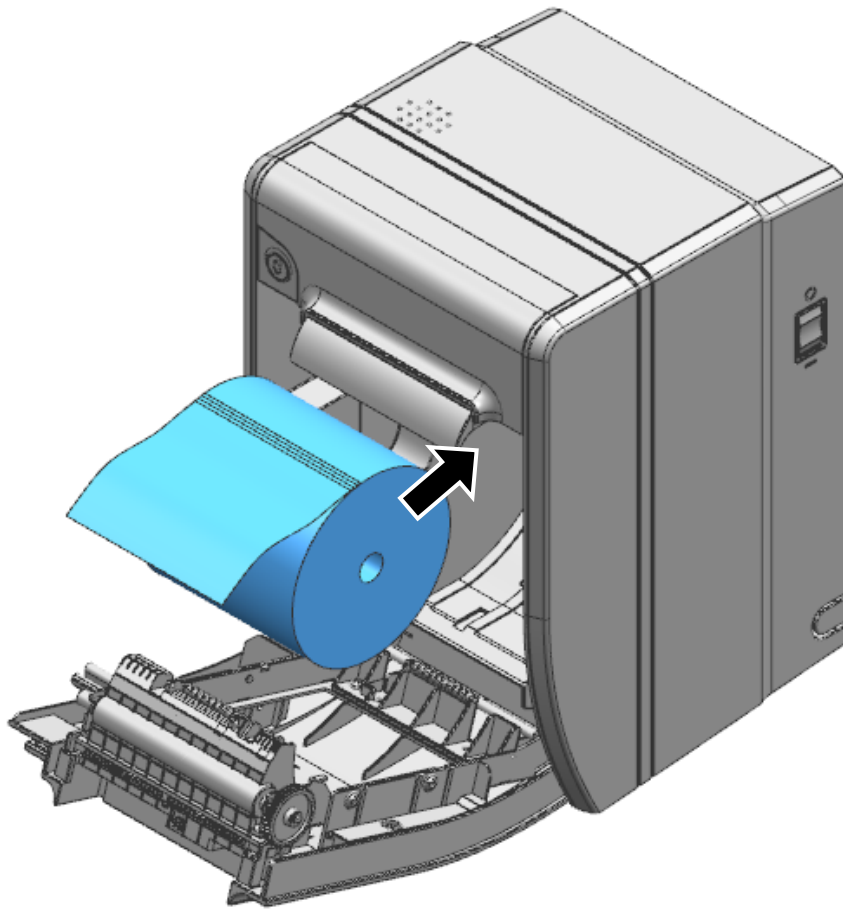

3) Check the orientation of the roll paper when inserting it into the printer.

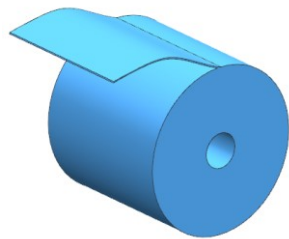

O

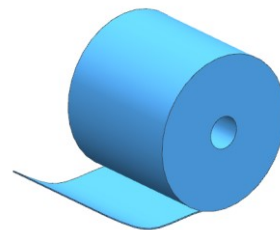

X

4) Pull out a small amount of paper as shown in the picture, and close the Printer Cover.

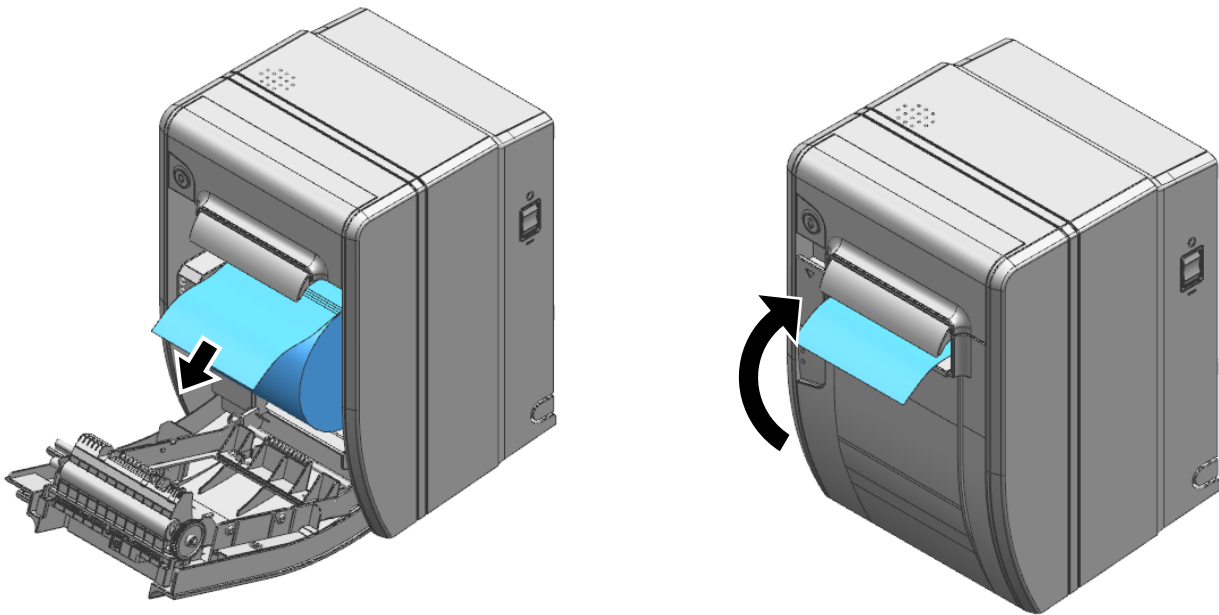

When closing the Printer Cover, hold down the center of printer cover firmly so that paper roll is loaded correctly.

3-4 Using Controller

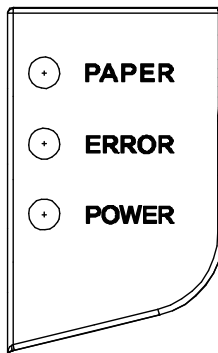
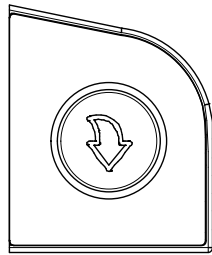

Explanation	
POWER LED	The Power LED light is on whenever the printer is on.
ERROR LED	Error LED is on when there is an error such as no paper roll, open cover, etc.
PAPER LED	Paper LED is on when the paper roll is almost used up or there is no paper roll inside. Paper LED flickers when the machine is in a self-diagnosis stand-by or macro execution stand-by state.
FEED Button	Press the Feed button once to output one line of the paper roll. Press the Feed button for more than 3 seconds to output the paper roll continuously.



If the printer does not power on, check that the adapter LED indicates "ON" If the adapter LED is "OFF", connect the adapter power.

3-5 Mounting Partition

- Position the partition on the front and back grooves and press the center part to fix it as shown in the picture. The position to secure the partition varies depending on the type of paper.

1. 40mm roll paper: mount 2 partitions at Positions #1 and #2.
2. 58mm roll paper: mount 1 partition at Position #1.
3. 62mm roll paper: mount 1 partition at Position #2.

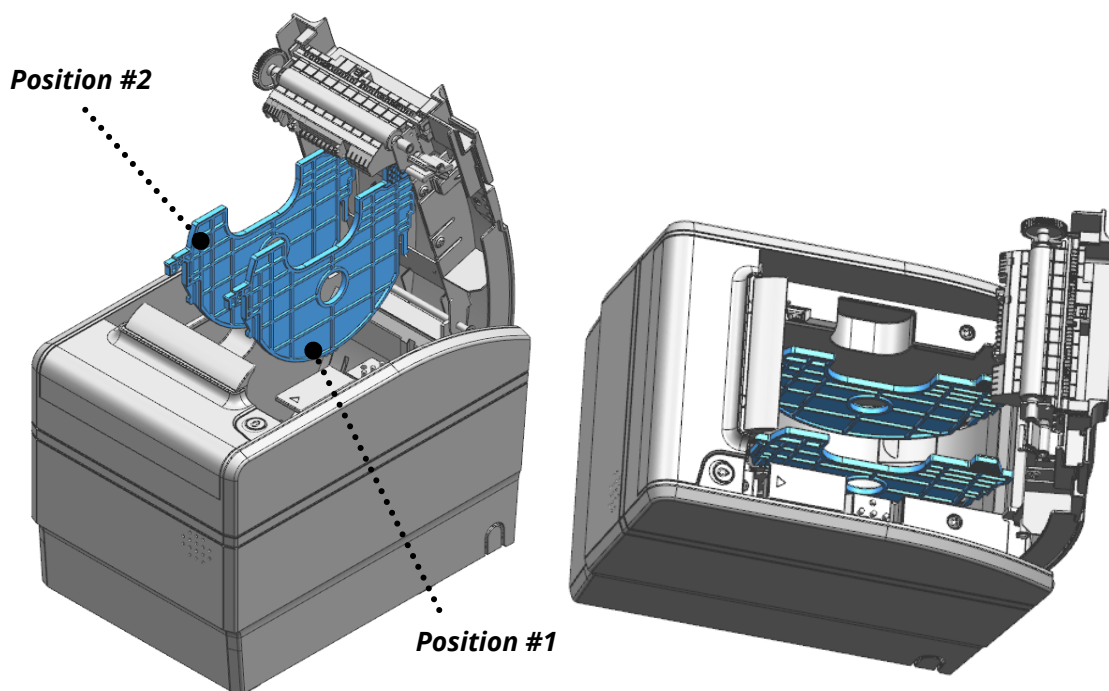

- After using narrower papers (e.g. 40, 58, 62mm width) than the maximum paper width of 80mm, please do not use any wider ones as it might affect printing quality due to uneven platen roller abrasion.

- Take care not to cut your finger on the surroundings of the part when installing the partition.



The shape of the partition is the same for each type of roll paper.

3-6 Setting Volume

- Use a cross-head screwdriver to adjust the volume.

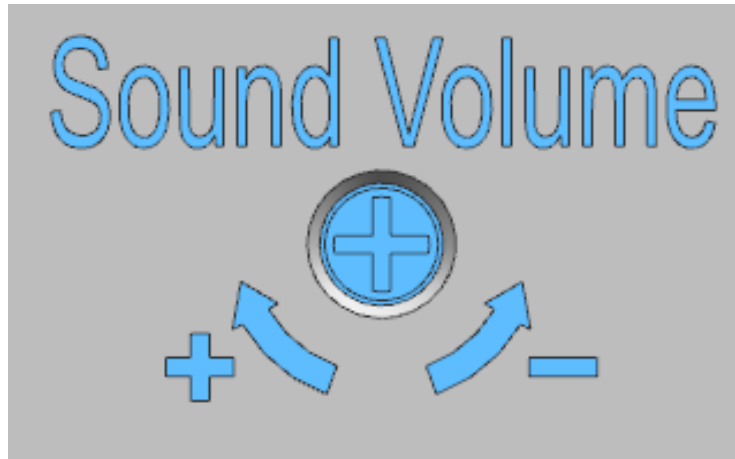
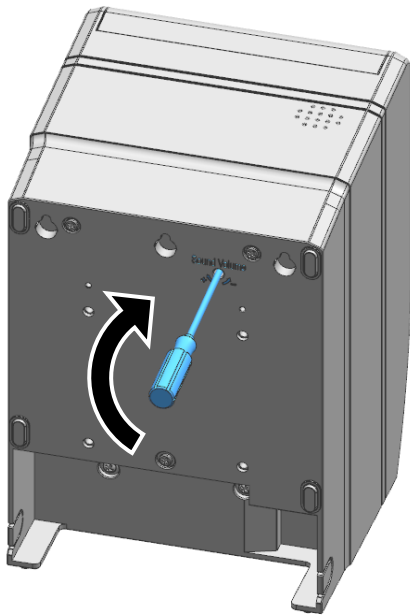

To mute the volume, turn it counter-clockwise all the way.

3-7 Taken Sensor Function

- When it comes to Taken Sensor, it will detect the paper not to feed next paper before user detach it.

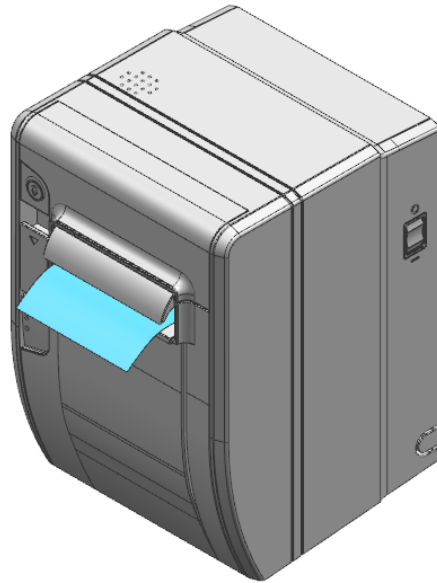

4. Printer Setting Change

This product supports virtual memory switch change the use the virtual memory switch utility. Use virtual memory switch management function for self-diagnosis.



- Turn the product power ON/OFF by using the virtual memory switch utility.
- For more details, please refer to Utility and Service Manual.

5. Self-Test

The self-test checks whether the printer has any problems.

If the self-diagnostics reveal no error in the printer, please see other device or software.

If the printer does not run normally, please contact the place of purchase.



- Do not open the top cover while the printer is running.

It may damage the printer.

- If the printer does not run normally, please contact Customer Center.

- 1) Make sure paper roll has been installed properly.
- 2) Turn on the power while holding down the FEED button and the self-test begins.
- 3) The self-test prints the current status of the printer including control ROM version.
- 4) After printing the current printer status, the printer wait for the next step after printing the following lines. (The paper signal light keeps blinking.)

SELF-TEST PRINTING.

Select a button to run the following.

Continue test printing : Press the button briefly

Memory switch configuration mode : Press and hold down button

- 5) Press the Feed button to resume printing or hold down the button for at least one second to change the VMSM settings.

(1) If "Continuous SELF-TEST" is selected

- ① Press the Feed button for less than one second to print the preset page.
- ② The self test ends automatically as it prints the following line and cuts the paper

***** COMPLETED *****

- ③ The printer goes into normal print mode upon completion of the self test.

(2) If "VMSM Selection" is selected

① The following lines will be printed when the VMSM opens.

<p style="text-align: center;">** VMSM Selection **</p> <p>0 : Exit and reboot printer</p> <p>1 : Print current settings</p> <p>2 : Set Print Density</p> <p>3 : Set Print Speed</p> <p>4 : Set Cutting mode</p> <p>5 : Beep-Once Alarm</p> <p>6 : Continuous Alarm</p> <p>7 : Set Black Mark Cut Position</p> <p>8 : Print Maintenance Counter</p> <p>9 or more : None</p>
--

② Press the Feed button to run the above function.

- ▶ Step 1(Select Options): press the button a number of times as shown by each menu.
- ▶ Step 2(Enter Options): hold down the button for at least one second to apply each item selected.



- If a selected item is not listed above, the list of "VMSM Selection" will be printed again. Setting the mode will be canceled if no item is selected in Step 1.
- If the "0: Save settings and exit" function is not executed, The setting information is not stored in the printer.

③ Hold down the Feed button for at least 1 second to save the changes.
The following line will be printed before cutting the paper.

<p>*** COMPLETED ***</p>

6) The new settings will be automatically applied when printer resets.

6. Hexadecimal Dumping

This function allows experienced users to see exactly what data is coming to the printer. This can be useful in finding software problems. When you turn on the hexadecimal dump function, the printer prints all commands and data in hexadecimal format along with a guide section to help you find specific commands.

- 1) After making sure that the printer is off, open the cover.
- 2) Turn the printer on, while holding down the FEED button.
- 3) Close the cover, and then the printer enters the hexadecimal dump mode.
- 4) Select the hexadecimal printing function in the mode selection menu to move to the hexadecimal printing mode.
- 5) Run any software program that sends data to the printer.
The printer will print all the codes it receives in a two-column format.
The first column contains the hexadecimal codes and the second column gives the ASCII characters that correspond to the codes.

```

1B 21 00 1B 26 02 40 40 40 40    . ! . . & . @ @ @ @
02 0D 1B 44 0A 14 1E 28 28 28    . . . D . . . . ( ( (
00 01 0A 41 0D 42 0A 43 43 43    . . . A . B . C C C

```

- A period (.) is printed for each code that has no ASCII equivalent.
- During the hex dump, all commands are disabled.

- 6) When the printing finishes, turn off the printer.
- 7) Turn on the printer and then the hexadecimal mode is off.



Contact the customer center if the printer does not enter hexadecimal printing mode.

7. Maintenance

7-1 Paper Jam

- Never force the paper out in the event of a paper jam.

If paper is stuck, turn the printer ON/OFF and open the Printer Cover to remove the crumpled paper inside the printer. If the cover will not open, please follow the following instructions.

- 1) Turn the printer OFF.
- 2) Pull out the Cutter Cover to separate from the printer.
- 3) Turn the knob and insert the blade that sticks out using a cross-head screwdriver as shown below.
- 4) Push the Cover Open Button and remove the jammed paper.
- 5) Put the Cutter Cover back in place.
- 6) Turn the Printer Cover ON and use it.

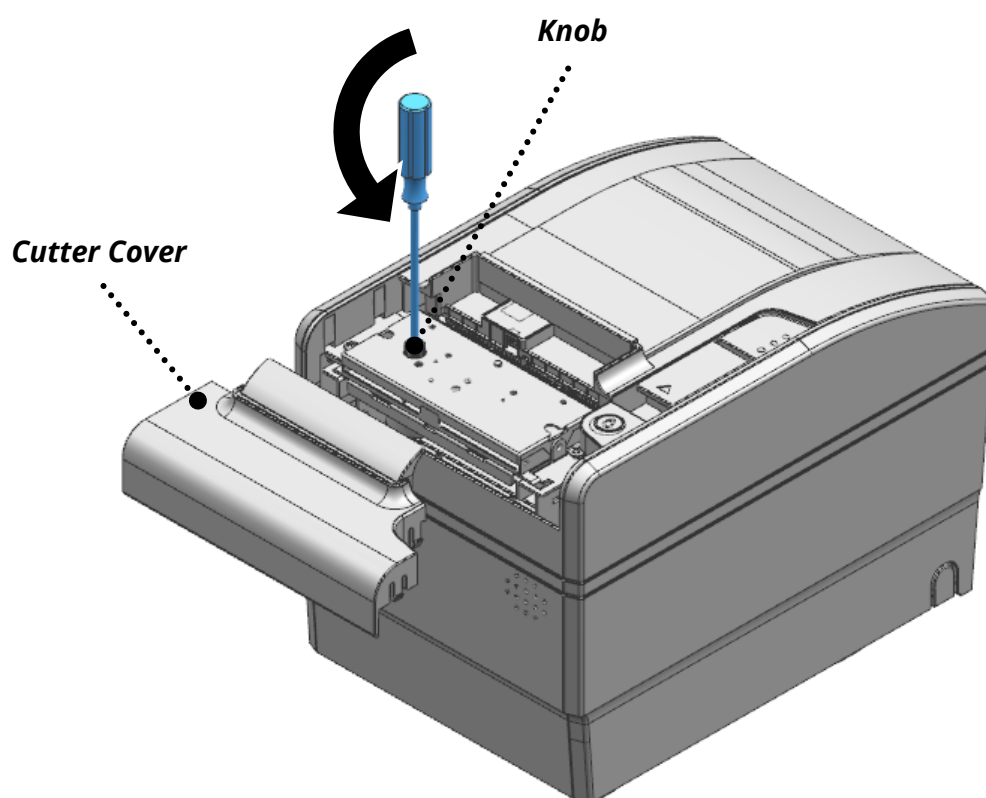

If the cover does not open, do not forcibly open it. It may result in poor paper cutting or printer damage.



- Placing your hand above the printer outlet may cause a paper jam.
- In case of a minor jam, it may be possible that the operating blade returns to the original position by turning the printer OFF and then back ON.

7-2 Cleaning Printer

- The presence of dust, foreign matter, adhesive matter, or other pollutants inside the printer's head and internal capacity may undermine printing quality. Periodic cleaning (every 3 months at minimum) is recommended to maintain print quality. It is recommended to clean after every 30 rolls when using Sticky, Re-stick, Linerless Extreme paper.

- 1) Open the printer cover and remove the paper currently in use.
- 2) Residue or contamination of printer head should be wiped out by alcohol for medical.
- 3) Clean the paper sensor and paper roller with a cotton swab or a dry cloth.
- 4) Clean the cutter blade with a cloth wet with medical alcohol.
- 5) Insert a paper roll and close the printer cover.

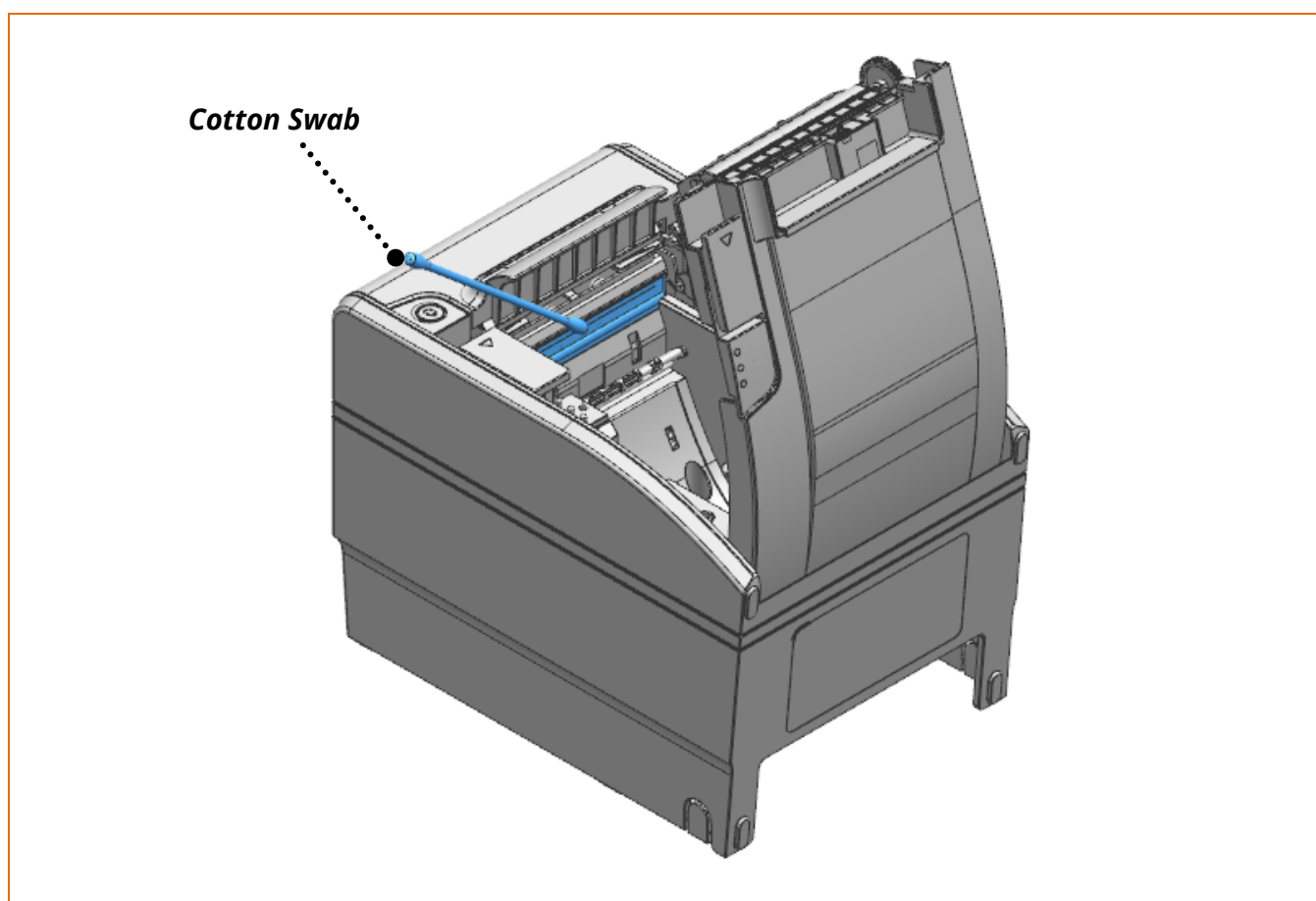

- Be sure to clean after turning the printer off.
- Be careful not to leave scratches in the print head
The printer may be damaged.
- Print head is very hot while the printer is printing, so clean the printer after cooling it sufficiently with power off.
- Do not touch heated area of print-head when cleaning.
Personal injury may result from static electricity, etc.

8. Specifications

8-1 Printer Specifications

Printing Method	Thermal printing	
Dot Density	203 dpi (8dots/mm)	
Paper Width / Printing Width	80mm	72mm
	62mm	60mm
	58mm	48mm
	40mm	32mm
Paper Width	79.5 ±0.5mm, 61.5 ±0.5mm, 57.5 ±0.5mm, 39.5 ±0.5mm	
No. of Characters per Line (Default Value)	48(Font A), 64(Font B), 64(Font C) ※ For 80mm Roll Paper	
Printing Speed	Max. 150 mm/sec	
Receiving Buffer Size	4K bytes	
Interface	S320K: Ethernet, USB S320SK: Ethernet, USB, Serial S320SDK: Ethernet, USB, Serial, RJ45 S320WDK: Ethernet, USB, Wireless LAN Dual S320BaK: Ethernet, USB, Bluetooth 5.2 S320HiK: Ethernet, USB, B-gate I/F	
AC/DC Adapter Supply Voltage	Input Voltage	100~240 VAC
	Frequency	50/60 Hz
	Output Voltage	24 VDC
Environment Condition	Temperature	Operating: 0 ~ 40 °C Storage: -20 ~ 60 °C
	Humidity	Operating: 10 ~ 80 % RH Storage: 10 ~ 90 % RH Paper excluded
Life Span	Printer Head	75 Km
	Auto Cutter	200,000 cuts



The specifications were determined based on operation at normal temperature using designated paper on default settings. They are subject to change depending on temperature or printing level. Printing speed may become slightly slower depending on the data transmission speed and the combination of commands.

8-2 Recommended Papers

- Iconex Sticky Media (USA):
 - Classic: 9023-1253, 9023-1232(80mm), 9023-1823, 9023-1397(58mm), 9023-1233, 9023-1818(40mm)
 - Classic High Tack: 9023-1254(80mm), 9023-1500(58mm), 9023-1258(40mm)
 - Classic High Temp: 9023-1267, 9023-1463 (80mm), 9023-1269(40mm)
 - Ultralite: 9023-1866(80mm), 9023-1410(58mm), 9023-1865(40mm)
 - Classic High Tack Plus: 9023-1846(80mm)
- Iconex Linerless Label (USA)
 - Linerless Extreme: 9023-1873, 9023-1708(40mm)
- MAX International Converters, Inc. MAXStick Products Ltd (USA)



- **The use of papers other than those recommended above may cause damage to the printer's TPH or degrade the printing quality. BIXOLON is not responsible for the damage caused by non-recommended papers.**
- **If you have to use other products, we recommend that you use papers with a similar level of quality to the recommended ones.**

