



WARNING & CAUTION

Is described as death, physical injuries, serious financial losses, and damage to data etc. that can be caused to the user.

Do not connect multiple products to a single or faulty power outlet. Only use grounded power outlets that meet the industry standard. **Noncompliance may cause electric shock or fire.**



Only use authentic products from BDXOLON. **The company will not provide post-sale support for damaged or other quality issues that any fake (or refurbished) products may incur.**



Do not excessively bend or strain the power cord. Securely push the power cord all the way into the power outlet; test it remain loose. Make sure to hold the cord tight when separating it from the power outlet. Do not remove the power cord while the product is in use. **Noncompliance may cause electric shock or fire.**



Keep small accessories or other packaging materials away from young children. Beware: choking hazard. **Mishandling the product may incur injuries which may require seeking urgent medical attention.**



Keep excessive liquids away from the power cord and outlet. If matter is smeared onto the power cords, wipe with a dry cloth. **Noncompliance may cause electric shock or fire.**



Do not allow the product to be damaged by heavy objects. **Noncompliance may cause electric shock or fire.**



If the product emits a strange sound, burning smell, or smoke, turn off the power immediately and unplug the power cord. If the product is dropped or its exterior is damaged, turn off the power immediately and unplug the power cord. Do not subject the product to shock. **This could cause damage to the product or a fire.**



Install the product in a well-ventilated area by keeping it a certain distance from the wall. Installing the product in certain environments which are prone to excessive dust, moisture and temperature fluctuations or putting the product under extreme use may cause damage to the printer. **Do increase in internal temperature if you are unsure of product placement.**



Install the product in a fixed location to prevent it from tipping over. When moving the product, turn off the power and disconnect all connected cables, including the power cord. **As it may damage the product.**



Never independently disassemble, repair, or modify the product as the warranty will become invalid. **When repair is necessary, contact the original place of purchase.**



Do not let any foreign substances enter the product. Do not place heavy objects, liquids, or metals on the product. **This could cause damage to the product or a fire.**



If there is a problem with the product, please contact the original place of purchase or through BDXOLON website's product repair page (www.bdxolon.com).



English



주의 & 경고

사용자의 사망 또는 신체적 손상, 심각한 재산상의 손상, 데이터 등의 정보 손상을 일으킬 가능성이 있는 내용을 설명합니다.

하나의 콘센트에 여러 제품을 동시에 연결하지 마세요. 알맞은 콘센트는 사용하지 마세요. 콘센트는 규격 제품을 사용하세요. 반드시 접지된 콘센트에 전용 코드를 연결하세요. 감전 및 화재의 위험이 있습니다.



반드시 박솔론에서 공급받은 정품만 사용하세요. 유사품(재생품) 사용으로 인한 제품손상에 대한 품질 및 A/S 책임을 지지 않습니다.



전원 코드를 무리하게 구부리거나 잡아당기지 마세요. 전원 코드 콘플러그는 꼭 단단히 꽂아주세요. 전원 코드를 콘센트에 분리할 때에는 반드시 코드를 잡고 분리해 주세요. 제품 사용 중에는 전원 코드를 뽑지 마세요. 감전 및 화재의 위험이 있습니다.



소형 액세서리 또는 포장물이나의 손에 닿지 않는 곳에 보관하세요. 어린이가 삼키지 않도록 주의하세요. 제품을 잘못 다루어 부상의 위험이 있습니다. 번역에 어긋날 경우엔 즉시 고객센터 상담하세요.



전원 코드 끝을 매듭을 매는 손으로 만지지 마세요. 전원 코드 끝 부분 또는 콘센트에 이물질이 묻어 있을 때에는 마른 천으로 깨끗이 닦아주세요. 감전 및 화재의 위험이 있습니다.



무거운 물건을 놓이지 않도록 주의하세요. 감전 및 화재의 위험이 있습니다.



제품에서 이상소리가 나거나 냄새, 연기, 검은 증기, 연기를 끄고 전원 코드를 뽑아주세요. 제품을 떨어뜨리거나 내압이 과한 경우 즉시 전원을 끄고 전원 코드를 뽑아주세요. 제품예중계를 주지 마세요. 화재의 위험이 있습니다. 제품 손상의 위험이 있습니다.



제품은 벽걸이형 기기로서 떨어지지 않는 곳에 설치하세요. 미세 먼지가 많이 발생하고, 온도 가늠이 불가능, 습기나 물이 많은 곳, 장시간 연속 사용으로 발생하는 공질이나 열 등 지속적인 사용에 따른 제품 내부 열 발생의 위험이 있습니다. 내부 온도 상승으로 인한 화재의 원인이 될 수 있습니다. 반드시 구입처 문의 후 설치하세요.



제품이 넘어지지 않도록 고정된 장소에 설치하세요. 제품을 옮길 때에는 전원을 끄고 전원 코드 등 제품에 연결된 모든 선을 뽑아주세요. 제품을 들거나 옮길 때에는 밑에 떨어뜨리 마세요. 제품 손상의 위험이 있습니다.



사용자 임의로 절단 분리, 수리, 개조하지 마세요. 수리가 필요할 때에는 구입처로 연락하세요.



제품 내부에 이물질이 들어가지 않도록 주의하세요. 제품 위에 무거운 물건이나 액체류나 금속류를 올려놓지 마세요. 화재의 위험이 있습니다. 제품 손상의 위험이 있습니다.



제품의 문제가 생겼을 경우 구입처로 연락하세요. 또한, 박솔론 홈페이지 (www.bdxolon.com)에서 제품 수리 동영상도 제공하고 있습니다.



Korean

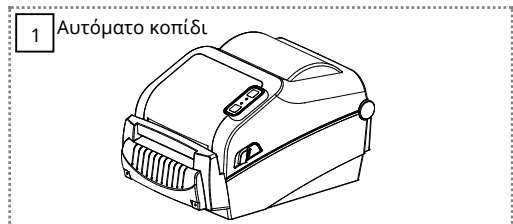
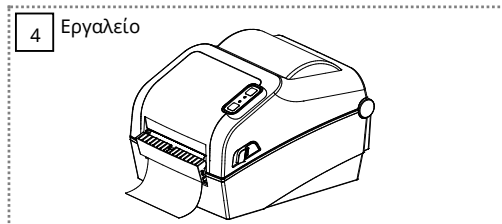
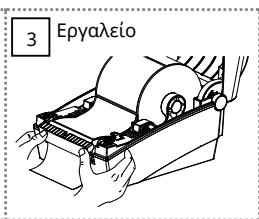
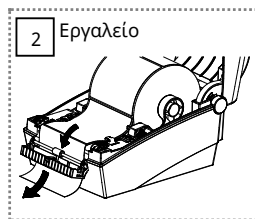
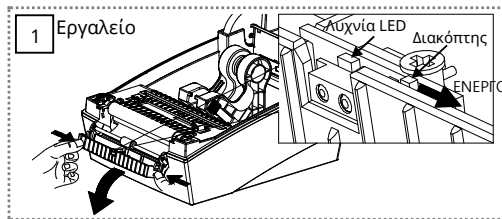
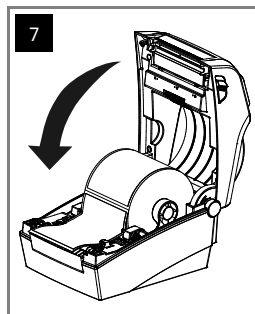
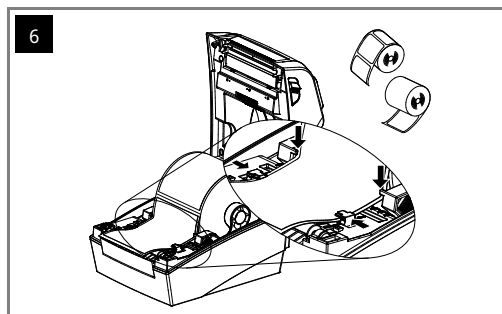
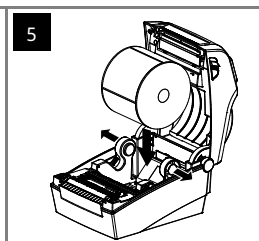
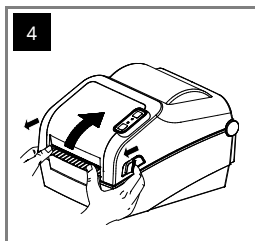
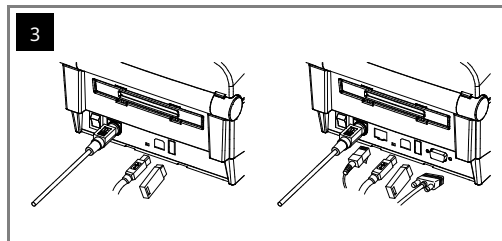
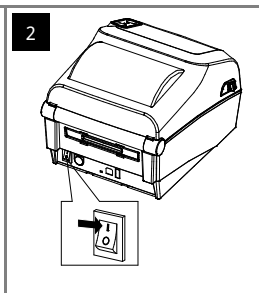
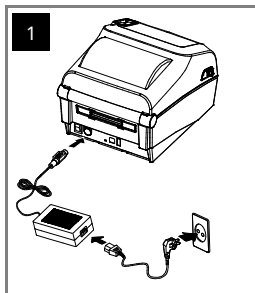
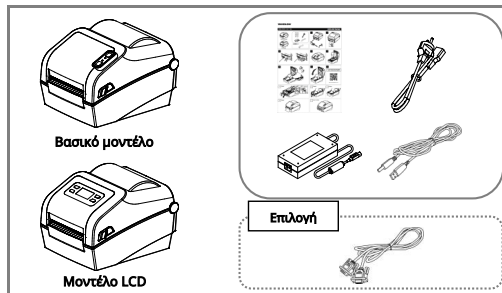

XD5-40d Series

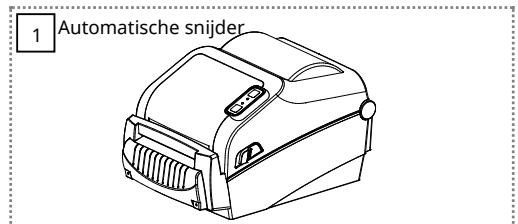
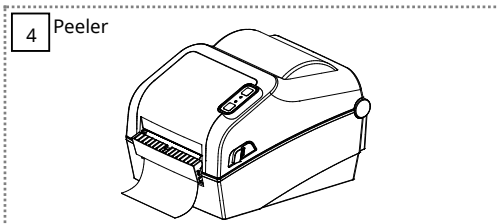
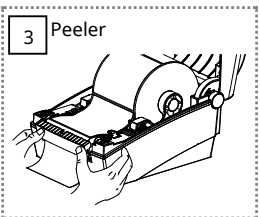
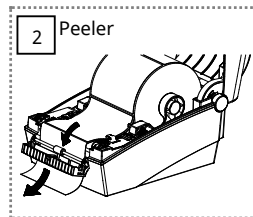
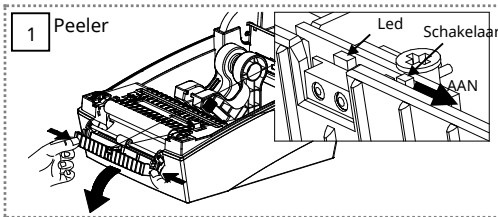
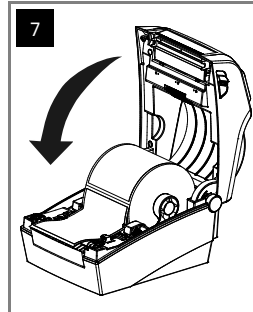
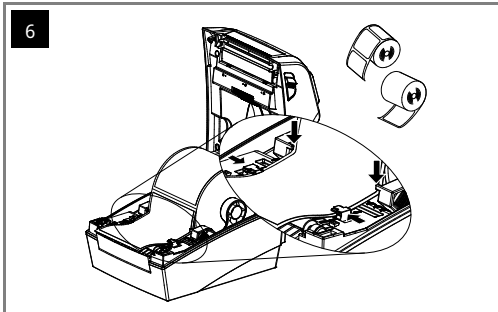
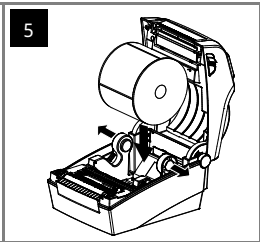
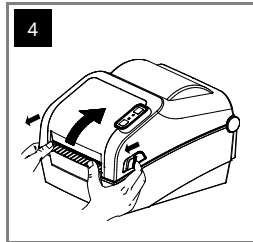
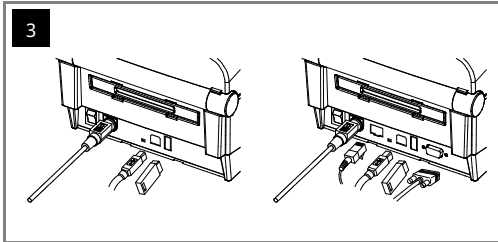
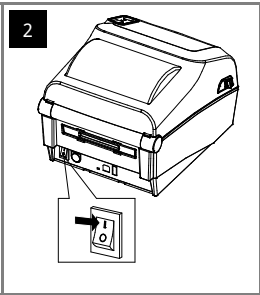
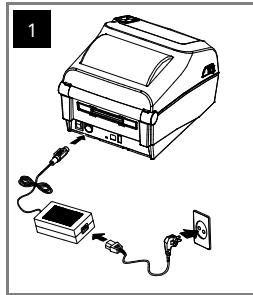
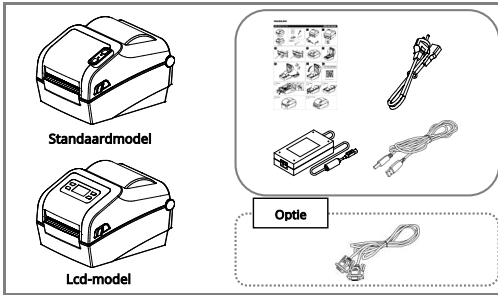

ΠΡΟΕΙΔΟΠΟΙΗΣΗ ΚΑΙ ΠΡΟΣΟΧΗ

Περιγράφεται ως θάνατος, σωματικοί τραυματισμοί, σοβαρές οικονομικές απώλειες και ζημιές σε δεδομένα κ.λπ. που μπορεί να προκληθούν στον χρήστη.



Μην συνδέετε πολλά προϊόντα σε μία μόνο πρίζα ή σε μια ελαττωματική πρίζα. Χρησιμοποιείτε μόνο γεωμετρικές πρίζες οι οποίες πληρούν τα βιομηχανικά πρότυπα. **Η μη συμμόρφωση μπορεί να προκαλέσει ηλεκτροπληξία ή πυρκαγιά.**



Χρησιμοποιείτε μόνο αυθεντικά προϊόντα της BXOLON. **Η εστίαση δεν θα παρέχει υποστήριξη μετά την πώληση για προϊόντα τα οποία έχουν καταστραφεί ή άλλα ζητήματα πωλητών που συνδέονται με προϊόντα από τρίτους ή ανακατασκευασμένα προϊόντα.**



Μην λιγάζετε ή καταπονεύετε υπερβολικά το καλώδιο ρεύματος. Διήγησε με σφρόδιση το καλώδιο ρεύματος μέχρι τέρμα στην πρίζα, καθώς δεν πρέπει να είναι χαλαρό. Βεβαιωθείτε ότι κρατάτε καλά το καλώδιο όταν το χρησιμοποιείτε στην πρίζα. **Μην γεμίζετε το καλώδιο ρεύματος ενόσω το προϊόν βρίσκεται σε χρήση. Η μη συμμόρφωση μπορεί να προκαλέσει ηλεκτροπληξία ή πυρκαγιά.**



Διαπρέψτε τα μακρά αέσομα ή άλλα υλικά συσκευασίας μακριά από μικρά παιδιά. Προσοχή: κίνδυνος πνιγμού. **Ο καθαρισμός χρησιμοποιού των προϊόντων μπορεί να προκαλέσει τραυματισμούς οι οποίοι ενδέχεται να απαιτούν επείγουσα ιατρική βοήθεια.**



Κρατήστε μεγάλες ποσότητες υγρών μακριά από το καλώδιο ρεύματος και την πρίζα. Σε περίπτωση που επαφίεται κάποια ουσία στα καλώδια ρεύματος, ακουσίστε με ένα στεγνό πανί. **Η μη συμμόρφωση μπορεί να προκαλέσει ηλεκτροπληξία ή πυρκαγιά.**



Μην επιτρέπετε καταστροφή του προϊόντος από βαριά αντικείμενα. **Η μη συμμόρφωση μπορεί να προκαλέσει ηλεκτροπληξία ή πυρκαγιά.**



Εάν το προϊόν εκπέμπει παχύ αχνό, λιμυδιά κίτρινο ή καφέ, απενεργοποιήστε αμέσως το ρεύμα και αποσυνδέστε το καλώδιο ρεύματος. Σε περίπτωση πνιγμού, το προϊόν ή ο φέρονος του εξοπλισμού περιγράφεται, απενεργοποιήστε αμέσως το ρεύμα και αποσυνδέστε το καλώδιο ρεύματος. **Μην υπερβείτε τον χρόνο νεφελώσεως. Εάν κάποιο μέρος μπορεί να προκαλέσει ζημιά στον προϊόν ή πυρκαγιά.**



Εγκαταστήστε το προϊόν σε καλά αεριζόμενο χώρο διαβίωσης, σε ανοικτή κατάσταση από τον τοίχο. Η εγκατάσταση του προϊόντος σε ανακλωματική περιβάλλουσα (στοιχείο εισαγωγής σε υπερβλήνη) είναι, γιγνώσκω και, θεωρητικά θεωρητικός ή καταστροφικός για το προϊόν και τα υλικά γύρω γιγνώσκω και, θεωρητικά (βλ. οδηγία στην ετικεταρί) θεωρητικός μπορεί να προκαλέσει πυρκαγιά. **Μην παραβιάζετε τις απαιτήσεις με το προϊόν και το οποίο σχετίζεται το προϊόν εάν δεν είναι σύμφωνα με την καταστροφή του.**



Εγκαταστήστε το προϊόν σε σταθερή θέση προς ασφαλή διεύθυνση αναρρόφησης. Όταν μετακινήσει το προϊόν, απενεργοποιήστε το ρεύμα και αποσυνδέστε όλα τα συνδεδεμένα καλώδια συμπεριλαμβανομένου του καλωδίου ρεύματος. **Κάτι τέτοιο μπορεί να βλάψει το προϊόν.**



Μην αποσυρμαολογείτε, επισκευάζετε ή τροποποιείτε ποτέ από μόνοι σας το προϊόν, καθώς η εγγύηση θα καταστεί άκυρη. **Όταν απαιτείται επισκευή, επικοινωνήστε με το κατάστημα από το οποίο προμηθευτήκατε την αγορά.**



Μην αφήνετε να ακουράζονται ξένες ουσίες στο προϊόν. Μην τοποθετείτε βαριά αντικείμενα, υγρά ή μέταλλα πάνω στο προϊόν. **Κάτι τέτοιο μπορεί να προκαλέσει ζημιά στο προϊόν ή πυρκαγιά.**



Εάν υπάρχει πρόβλημα με το προϊόν, επικοινωνήστε με το κατάστημα από το οποίο αγοράσατε το προϊόν ή με τη σελίδα επισκευής προϊόντων του ιστότοπου BXOLON (www.bxolon.com).



WAARSCHUWINGEN

Wordt beschreven als overlijden, lichamelijk letsel, ernstige financiële verliezen en schade aan gegevens enz. die aan de gebruiker kunnen worden toegebracht.



Sluit niet meerdere producten aan op één stopcontact of op een defect stopcontact. Gebruik alleen gearde stopcontacten die voldoen aan de industriestaandaard. **Als u zich niet aan de voorschriften houdt, kan dit leiden tot elektrische schokken of brand.**



Gebruik alleen authentieke producten van BXOLON. **Het bedrijf biedt geen ondersteuning na de verkoop voor beschadigde of andere kwaliteitsproblemen die kunnen optreden bij namaakproducten (of vervalste) producten.**



Buig of belast het netsnoer niet te veel. Zorg dat de stekker correct in het stopcontact zit. Trek altijd aan de stekker en niet aan het snoer als u de stekker uit het stopcontact wilt halen. Verwijder het netsnoer niet terwijl het product in gebruik is. **Als u zich niet aan de voorschriften houdt, kan dit leiden tot elektrische schokken of brand.**



Houd kleine accessoires of ander verpakkingsmateriaal buiten het bereik van jonge kinderen. **Verkeerd gebruik van het product kan leiden tot verwondingen waarvoor dringend medische hulp nodig is.**



Houd vloeistoffen uit de buurt van het netsnoer en het stopcontact. Reinig het netsnoer met een droge doek. **Als u zich niet aan de voorschriften houdt, kan dit leiden tot elektrische schokken of brand.**



Zorg ervoor dat het product niet wordt beschadigd door zware voorwerpen. **Als u zich niet aan de voorschriften houdt, kan dit leiden tot elektrische schokken of brand.**



Als het product een vreemd geluid, een brandgurg of rook afgeeft, schakel dan onmiddellijk de stroom uit en trek de stekker uit het stopcontact. Als het product uit of de buitenkant beschadigd is, schakel dan onmiddellijk de stroom uit en trek de stekker uit het stopcontact. **Stel het product niet bloot aan schokken. Dit kan schade aan het product of brand veroorzaken.**



Installeer het product in een goed geventileerde ruimte. Houd altijd enige afstand tot de muur. Als u het product installeert in bepaalde omgevingen die gevoelig zijn voor overmatig stof, vocht en temperatuurschommelingen of wanneer het product extreem warm wordt gebruikt, kan de printer beschadigd raken. Een verhoging van de binnen temperatuur kan brand veroorzaken. **Neem contact op met de plaats van aankoop als u niet zeker bent van de plaatsing van het product.**



Installeer het product op een vaste locatie om te voorkomen dat het omvalt. Schakel tijdens het verplaatsen van het product de stroom uit en koppel alle aangesloten kabels los, inclusief het netsnoer. **Kabels kunnen tijdens het transport of de verplaatsing beschadigd raken.**



Demonteer, repareer of wijzig het product nooit zelfstandig, aangezien anders de garantie vervalt. **Als reparatie nodig is, neem dan contact op met de oorspronkelijke plaats van aankoop.**





Zorg ervoor dat er geen vreemde stoffen in het product terechtkomen. Plaats geen zware voorwerpen, vloeistoffen of metalen op het product. **Dit kan schade aan het product of brand veroorzaken.**



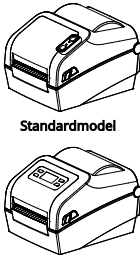

Als er een probleem is met het product, neem dan contact op met de oorspronkelijke plaats van aankoop of via de productreparatiepagina van de BXOLON-website (www.bxolon.com).

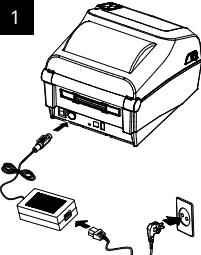
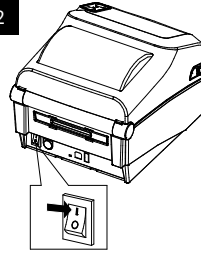

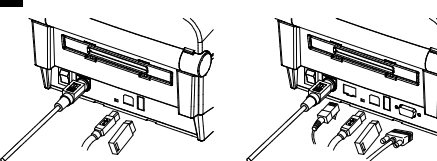
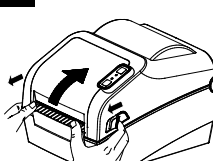
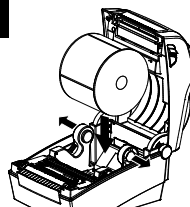
 <p>Standardmodel</p> <p>LCD-model</p>	 <p>Ekstraudstyr</p>	<p>1</p> 	<p>2</p> 
------------------------------------------------------------------------------------------------------------------------	-------------------------------------------------------------------------------------------------------	--------------------------------------------------------------------------------------------	---------------------------------------------------------------------------------------------

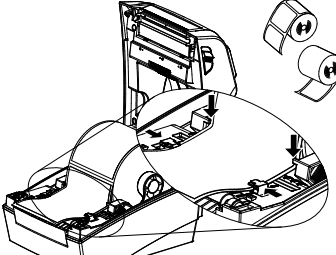
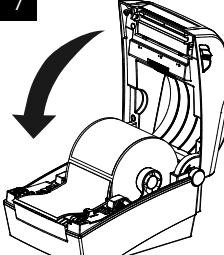
<p>3</p> 	<p>4</p> 	<p>5</p> 
-------------------------------------------------------------------------------------------	--------------------------------------------------------------------------------------------	---------------------------------------------------------------------------------------------

<p>6</p> 	<p>7</p> 	<p>8</p> <p>For yderligere information bedes du besøge BIXOLONs hjemmeside.</p> 
---------------------------------------------------------------------------------------------	---------------------------------------------------------------------------------------------	-------------------------------------------------------------------------------------------------------------------------------------------------------------------

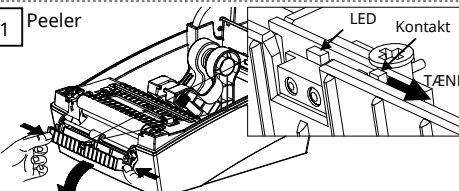
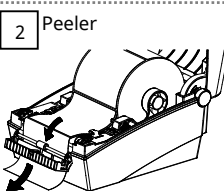
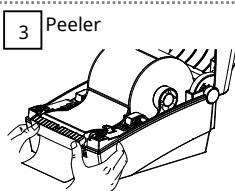
<p>1 Peeler</p> 	<p>2 Peeler</p> 	<p>3 Peeler</p> 
----------------------------------------------------------------------------------------------------	-----------------------------------------------------------------------------------------------------	------------------------------------------------------------------------------------------------------

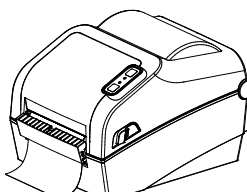
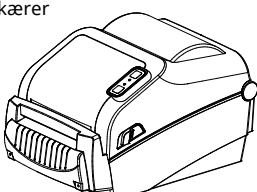
<p>4 Peeler</p> 	<p>1 Auto-skærer</p> 
-----------------------------------------------------------------------------------------------------	----------------------------------------------------------------------------------------------------------

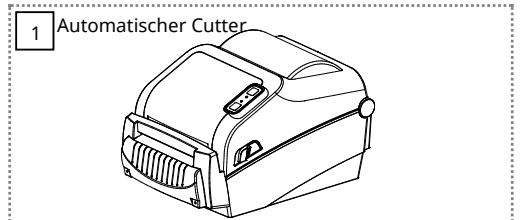
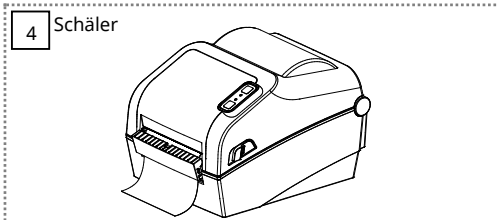
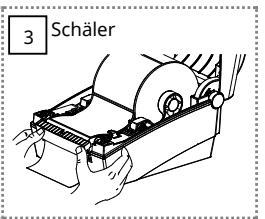
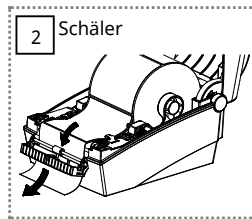
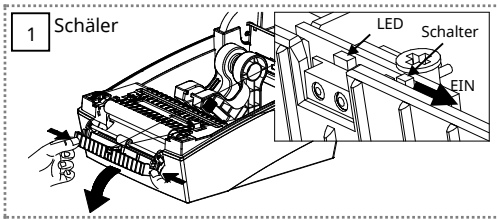
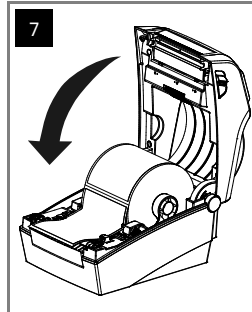
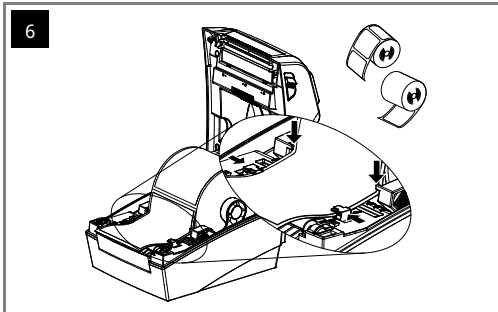
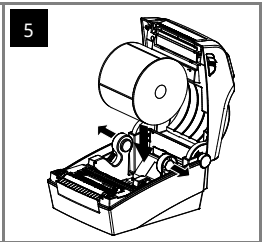
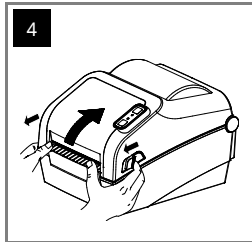
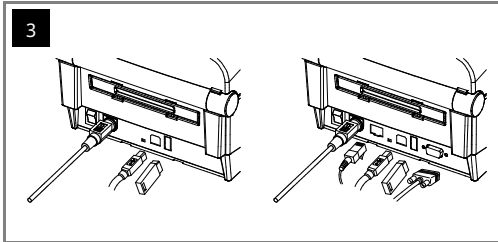
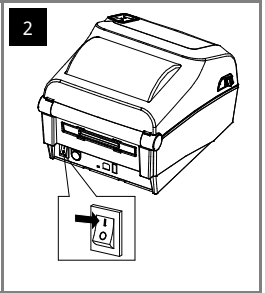
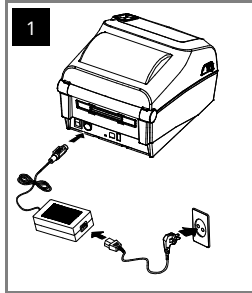
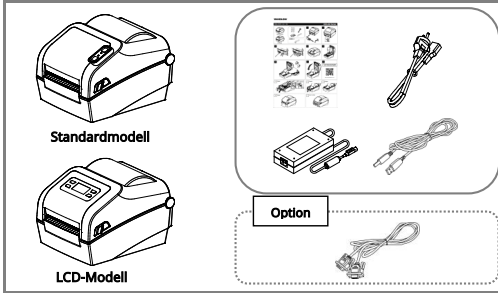



ADVARSEL OG FORSIGTIGHED

Beskrives som død, fysiske skader, alvorlige økonomiske tab og beskadigelse af data m.m., der kan påføres brugeren.



WARNUNG & VORSICHTSMAßNAHMEN

Durch Nichtbeachtung der nachstehenden Hinweise kann es zu Datenschutz, Vermögensschäden, schweren Personenverletzungen oder tödlichen Unfällen kommen.

Tilslut ikke flere produkter til en enkelt eller defekt stikkontakt. Brug kun stikkontakter med jordforbindelse, der opfylder industristandarden. **Manglende overholdelse kan forårsage elektrisk stød eller brand.**



Brug kun autentiske produkter fra BDOLON. **Vrilsomheden yder ikke support eller salg ved skade eller andre kvalitetsproblemer, som eventuelle falske (eller renoverede) produkter kan påføre sig.**



Schlüssen Sie nicht mehrere Produkte an eine einzige fehlerhafte Steckdose an. Verwenden Sie nur geerdete Steckdosen, die den Industriestandard entsprechen. **Eine Nichtbeachtung kann zu einem elektrischen Schlag oder zu einem Brand führen.**



Verwenden Sie nur authentische Produkte von BDOLON. **Das Unternehmen bietet keinen Support für beschädigte oder sonstige Qualitätsprobleme, die bei gefälschten (oder generalüberholten) Produkten nach dem Kauf auftreten können.**



Undgå at bøjle eller belast strømkablet for meget. Skud strømkablet helt ind i stikkontakten, så det ikke sidder løst. Sørg for at holde godt fast i kablet, når du tager det ud af stikkontakten. Fjern ikke strømkablet, mens produktet er i brug. **Manglende overholdelse kan forårsage elektrisk stød eller brand/musning.**



Hold små tilbehør eller andet emballagemateriale væk fra små børn. Pas på: fare for kvæstning. **Forkert håndtering af produktet kan medføre skader, som kan kræve akut lægehjælp.**



Biegen oder belasten Sie das Netzkabel nicht übermäßig. Stecken Sie das Netzkabel fest in die Steckdose, damit es nicht lose ist. Achten Sie darauf, das Kabel festzuhalten, wenn Sie es von der Steckdose nehmen. Entfernen Sie das Netzkabel nicht, während das Produkt verwendet wird. **Eine Nichtbeachtung kann zu einem elektrischen Schlag oder zu einem Brand führen.**



Halten Sie kleine Zubehöreile oder andere Verpackungsmaterialien von kleinen Kindern fern. Achtung: Erstickengefahr. **Eine unsachgemäße Handhabung des Produkts kann zu Verletzungen führen, die möglicherweise dringende medizinische Maßnahmen erfordern.**



Hold større mængder væske væk fra strømkablet og stikkontakten. Hvis der er smurt stof på strømkablet, skal du tørre dem af med en tavs klud. **Manglende overholdelse kan forårsage elektrisk stød eller brand.**

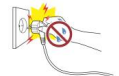

Lad ikke produktet blive beskadiget af tunge genstande. **Manglende overholdelse kan forårsage elektrisk stød eller brand.**



Halten Sie übermäßige Flüssigkeiten vom Netzkabel und der Steckdose fern. Wenn die Netzkabel verschmiert sind, wischen Sie sie mit einem trockenen Tuch ab. **Eine Nichtbeachtung kann zu einem elektrischen Schlag oder zu einem Brand führen.**



Lassen Sie das Produkt nicht durch schwere Gegenstände beschädigen. **Eine Nichtbeachtung kann zu einem elektrischen Schlag oder zu einem Brand führen.**



Hvis produktet udsender en mærkelig lyd, en brændende lugt eller røg, skal du straks slukke for strømmen og tage strømkablet ud. Hvis produktet tabes eller beskadiges uventet, skal du straks slukke for strømmen og trække strømkablet ud. Læs det produktet for stød. **Det kan medføre skader på produktet eller brand.**



Installer produktet i et godt ventileret område ved at holde det i en vis afstand fra væggen. Hvis produktet installeres i visse miljøer, der er udsat for meget støv, fugt og temperaturudsving, eller hvis produktet udsættes for ekstrem brug kan prinneren blive beskadiget. En stigning i den indre temperatur kan starte en brand. **Sørg for at kontaktes autoriserede for, hvis du er i tvivl om produktets placering.**



Wenn das Produkt ein seltsames Geräusch, Brandgeruch oder Rauch abgibt, schalten Sie es sofort aus und ziehen Sie das Netzkabel ab. Wenn das Produkt fallen gelassen oder äußerlich beschädigt wird, schalten Sie es sofort aus und ziehen Sie das Netzkabel ab. Setzen Sie das Produkt keinen Stößen aus. **Dies könnte zu Schäden am Gerät oder zu einem Brand führen.**



Isolieren Sie das Produkt in einem gut belüfteten Bereich und halten Sie einen gewissen Abstand zur Wand. Wenn Sie das Produkt bestimmten Umgebungsbedingungen wie übermäßigem Staub, Feuchtigkeit, oder Temperaturauschwankungen aussetzen, oder es einem starken Stoß ausgesetzt wird, kann die Prinneren beschädigt werden. **Ein Zuwärmen der internen Temperatur kann einen Brand auslösen. Wenden Sie sich an Ihren Händler, wenn Sie sich bezüglich der Produktplatzierung nicht sind.**



Installer produktet på et fast sted for at forhindre, at det vælter. Når du flytter produktet, skal du slukke for strømmen og frakoble alle tilsluttede kabler, inklusive strømkablet. **Det kan beskadige produktet.**



Du må aldrig selv adskille, reparere eller ændre produktet, da garantien da vil blive ugyldig. **Hvis reparation er nødvendig, skal du kontakte det oprindelige købssted.**



Installieren Sie das Produkt an einem festen Ort, um ein Umkippen zu verhindern. Wenn Sie das Produkt bewegen wollen, schalten Sie es aus und trennen Sie alle angeschlossenen Kabel, einschließlich des Netzkabels. **Andernfalls kann dies das Produkt beschädigen kann.**



Zerlegen, reparieren oder modifizieren Sie das Produkt niemals selbstständig, da andernfalls die Garantie erlischt. **Wenn ein Reparatur erforderlich ist, wenden Sie sich an die ursprüngliche Verkaufsstelle.**



Lad ikke fremmede substanser komme ind i produktet. Anbring ikke tunge genstande, væsker eller metaller på produktet. **Det kan medføre skader på produktet eller brand.**



Hvis der er et problem med produktet, bedes du kontakte det oprindelige købssted eller besage BDOLONs hjemmeside på produktreparationssiden (www.bdolon.com)



Lassen Sie keine Fremdstoffe in das Produkt eindringen. Stellen Sie keine schweren Gegenstände, Flüssigkeiten oder Metalle auf das Produkt. **Dies könnte zu Schäden am Produkt oder einem Brand führen.**



Wenn es ein Problem mit dem Produkt gibt, wenden Sie sich bitte an die ursprüngliche Verkaufsstelle oder über die Produktreparaturseite der BDOLON-Website (www.bdolon.com).



Danish

German

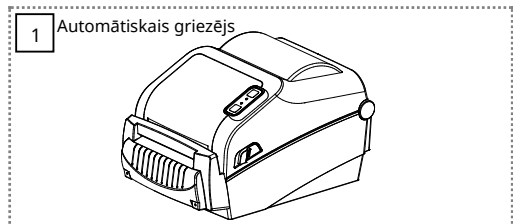
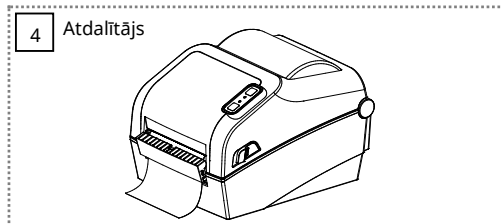
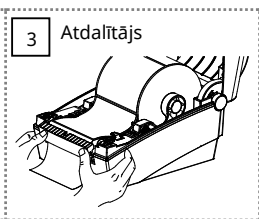
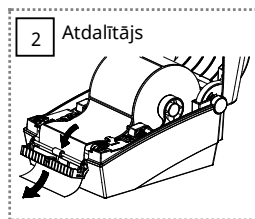
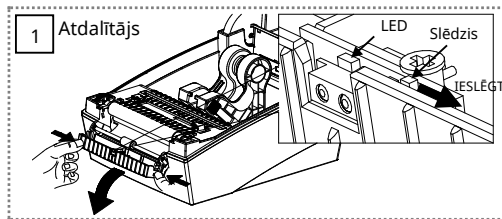
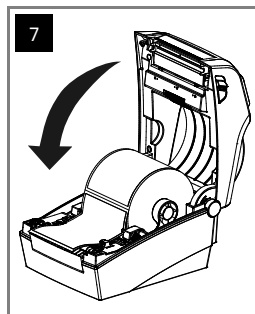
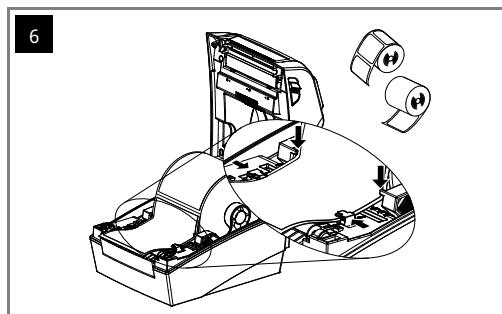
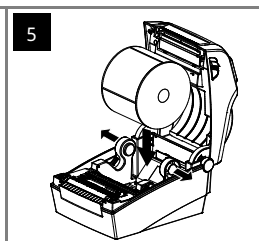
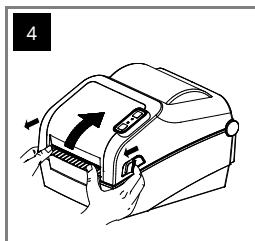
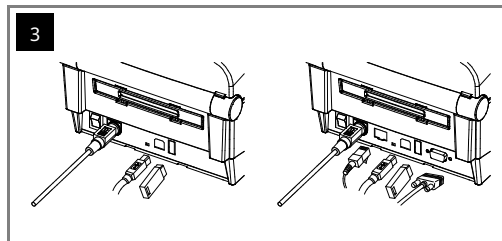
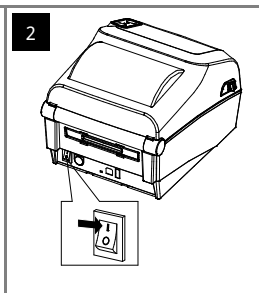
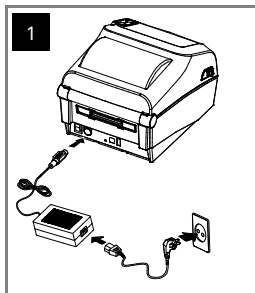
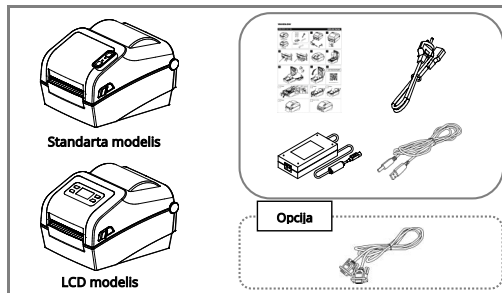

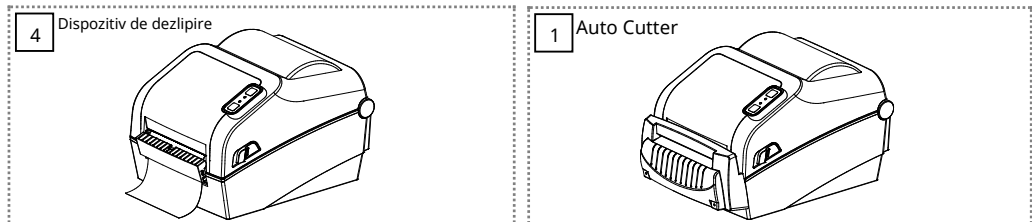
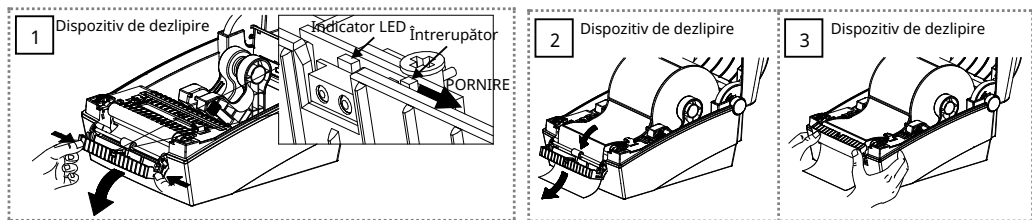
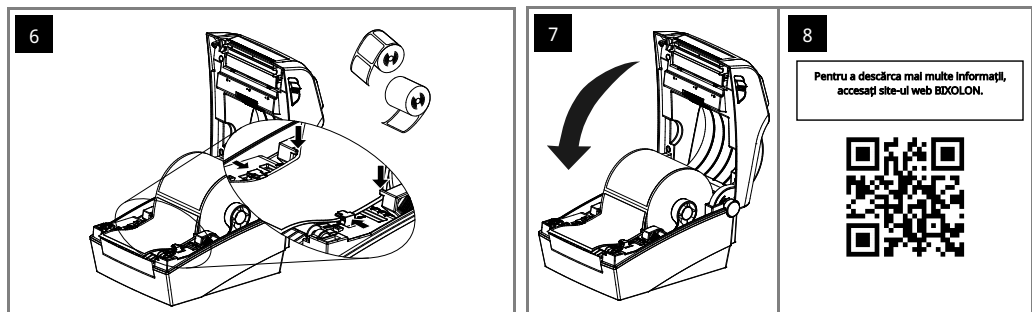
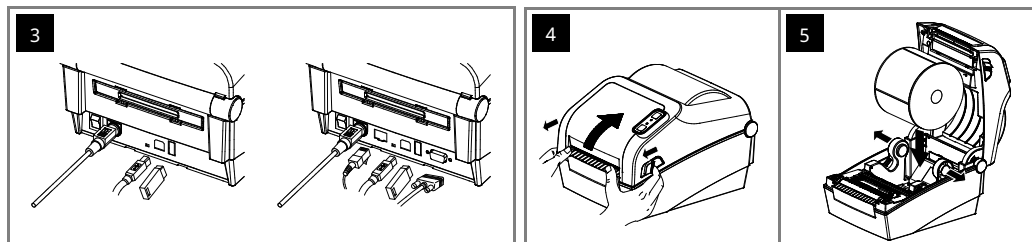
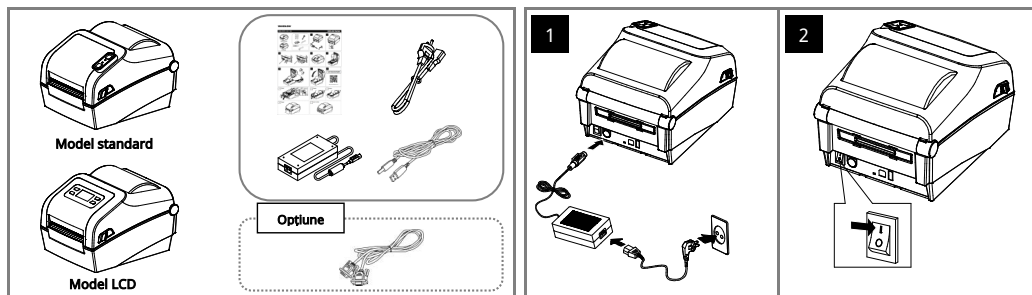

BRIDINĀJUMS / IEVĒROT PIESARDZĪBU

Nozīmē nāvi, traumas, nopietnus finansiālus zaudējumus, datu bojājumus u.c., kas var tikt nodarīti lietotājam.



Nepieslēdziet vairākus izstrādājumus vienai vai bojātai strāvas kontaktligzdai. Izmantojiet tikai tādas izņemtas kontaktligzdas, kas atbilst nozāres standartiem. **Neievērojšana var izraisīt strāvas triecienu vai ugunsgrēku.**



Izmantojiet tikai autentiskus BIXOLON izstrādājumus. **Uzņēmums nesniedz pārbaudāmas atbilstu bojājumu vai citu kvalitātes problēmu gadījumā, kas var rasties saistībā ar viltotiem (vai atņemotiem) izstrādājumiem.**



Pārmetņi nelieciet uz nenestiprēt strāvas vada. Droši atbilst strāvas vada tīrīšanai strāvas kontaktligzdā, lai tas nepaliktu vaļīgs. Pārlicieties, kas, atvienojot vadu no strāvas kontaktligzdas, **var būt droši. Neievērojot strāvas vadu, kamēr izstrādājums tiek lietots, Neievērojšana var izraisīt strāvas triecienu vai ugunsgrēku.**



Nelietus piederumus vai citus leģaļojuma materiālus glabājiet tā, lai tie nebūtu pieejami mazbērniem. Uzmanieties aizsērās risks. **Neapstrādātie aparāti ar izstrādājumu var radīt traumas, turu daļi vai citu nepieciešama zinātniska medicīniska palīdzība.**



Uzglabājiet lietus šķidrums daudzu mēnešu tālu no strāvas vada un kontaktligzdas. Ja uz strāvas vadiem ir uzsmērēta kāda viela, noslaukiet to ar sausu drānu. **Neievērojšana var izraisīt strāvas triecienu vai ugunsgrēku.**



Nepieļaujiet, ka izstrādājumu sabojā smagi priekšmeti. **Neievērojšana var izraisīt strāvas triecienu vai ugunsgrēku.**



Ja izstrādājums rada dīvānu skaņu, deguma smaržu vai dūmus, nekavējoties izslēdziet strāvas padevi un atvienojiet strāvas vadu. Ja izstrādājums ir nokritis vai tā puse ir bojāta, nekavējoties izslēdziet strāvas padevi un atvienojiet strāvas vadu. **Nepieļaujiet izstrādājumu triecieniem. Tas var izraisīt izstrādājuma bojājumus vai ugunsgrēku.**



Uzstādiet izstrādājumu labā vēdināmā vietā, ievērojot noteiktu attālumu no sienas. Izstrādājuma uzstādīšana noteiktās vietās, kurās ir tendence uz pārmetņu padevi, mēģinājumus daudzu mēnešu vadītājiem, vai izstrādājuma izmantošana elektrotīrīšanas apstākļos var izraisīt priekšmetu bojājumus, iekšējo temperatūras paaugstināšanos vai izraisīt ugunsgrēku. **Ja nepieciešams, pārbaudiet izstrādājuma novietojumu, saasināšanos ar priekšmetu vai ugunsgrēku.**



Uzstādiet izstrādājumu stabilā vietā, lai novērstu tā apgāzanos. Pārvejojiet izstrādājumu, izslēdzot strāvas padevi un atvienojot vākus pievienotus vadus, tostarp strāvas vadu. **Cilvēki var sabojāt izstrādājumu.**



Nekad patstāvīgi neizjauciet, neregulējiet vai neveiciet izmaiņas izstrādājuma, jo tas garantija zaudēs spēku. **Ja nepieciešams remonts, sazinieties ar sākotnējo iegādes vietu.**



Nepieļaujiet, ka izstrādājuma nonāk jebkādas sveķiem. Nenovietojiet uz izstrādājuma smagus priekšmetus, šķidrums vai metālus. **Tas var izraisīt izstrādājuma bojājumus vai ugunsgrēku.**



Ja rodas problēmas ar izstrādājumu, lūdz, sazinieties ar sākotnējo iegādes vietu vai izstrādājumu remonta lapu (www.bixolon.com).



Latvian

AVERTISMENT ȘI ATENȚIONĂRI

Indică evenimente precum deces, vătămări fizice, pierderi financiare grave și deteriorare a datelor etc. pe care le poate suferi utilizatorul.



Nu conectați mai multe produse la o singură priză sau la o priză defectă. Utilizați numai prize cu împământare, care îndeplinesc standardele din domeniu. **Nerespectarea acestor prevederi poate provoca electrocutare sau incendiu.**



Folosiți numai produse autentice de la BIXOLON. **Compania nu va oferi asistență post-vânzare pentru probleme legate de deteriorări sau alte probleme de calitate, care pot apărea ca urmare a unor produse false (sau recondiționate).**



Nu îndoiți și nu întindeți excesiv cablul de alimentare. Împingeți bine cablul de alimentare până la capăt în priză de alimentare astfel încât să nu alină. Asigurați-vă că șneți bine de cablu atunci când îl trageți din priză. Nu scoateți cablul de alimentare în timp ce produsul este în uz. **Nerespectarea acestor prevederi poate provoca electrocutare sau incendiu.**



Tineți accesoriile mici sau alte materiale de ambalare departe de cogli mici. **Atenție: pericolul de sufocare. Manipularea greșită a produsului poate provoca răniri care pot necesita solicitarea de asistență medicală urgentă.**



Tineți lichidele departe de cablul de alimentare și de priză. Dacă lichidul ajunge pe cablurile de alimentare, ștergeți cu o lavetă uscată. **Nerespectarea acestor prevederi poate provoca electrocutare sau incendiu.**



Nu permiteți ca produsul să fie deteriorat de obiecte grele. **Nerespectarea acestor prevederi poate provoca electrocutare sau incendiu.**



Dacă produsul emite un sunet neobișnuit, degajă miros de ars sau fum, opriți imediat alimentarea și deconectați cablul de alimentare. Dacă produsul a căzut sau este deteriorat sau este deteriorat, opriți imediat alimentarea și deconectați cablul de alimentare. Nu supuneți produsul la șocuri. **Acest lucru ar putea cauza deteriorarea produsului sau un incendiu.**



Instalați produsul într-o zonă bine aerisită. Ținând o anumită distanță față de perete. Instalarea produsului în anumite medii care sunt produse la o profundă umiditate și fluctuante de temperatură sau utilizarea excesivă a produsului poate cauza deteriorarea inițială. O umiditate în exces poate provoca incendiu. **Atenție: peretele și lucrurile din jur pot fi deteriorate de produsul dacă este instalat în locuri care nu sunt adecvate.**



Instalați produsul într-un loc fix, pentru a preveni răsturnarea acestuia. Când mutați produsul, opriți alimentarea și deconectați toate cablurile conectate, inclusiv cablul de alimentare. **În caz contrar, produsul poate fi deteriorat.**



Nu dezasamblați, nu reparați și nu modificați niciodată produsul pe cont propriu, deoarece acest lucru duce la anularea garanției. **Când este necesară repararea, contactați locul de unde ați achiziționat inițial produsul.**



Nu lăsați niciodată substanță străină să pătrundă în produs. Nu apăsați obiecte grele, lichide sau metale pe produs. **Acest lucru ar putea cauza deteriorarea produsului sau un incendiu.**



Dacă există o problemă cu produsul, contactați locul de unde ați achiziționat inițial produsul sau accesați pagina de reparații a produsului, de pe site-ul web BIXOLON (www.bixolon.com).



Romanian



Standartinis modelis



Skystųjų kristalų

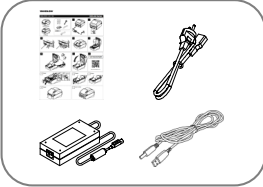

Parinktis



1

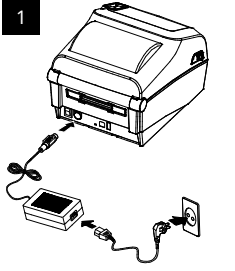

2

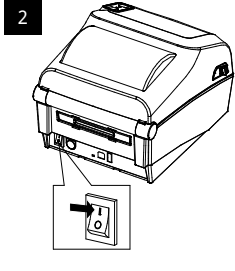

3

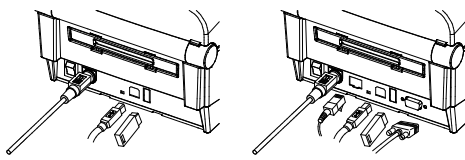

4

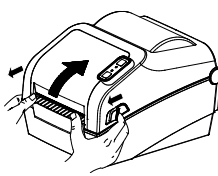

5

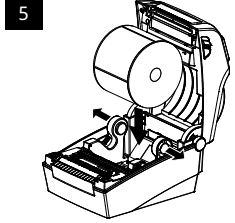

6

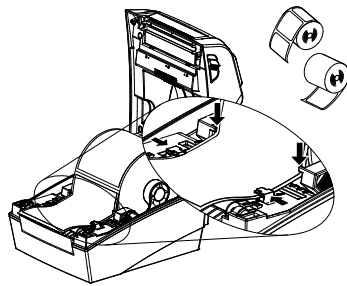

8

Norėdami atsilusti daugiau informacijos, apsilankykite BIXOLON svetainėje.



1 Skustukas

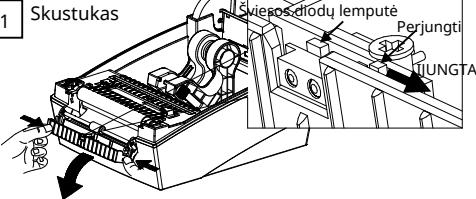

2 Skustukas

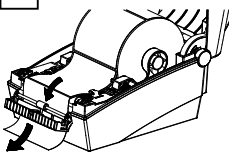

3 Skustukas

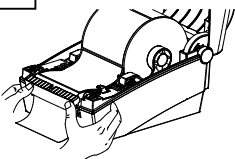

4 Skustukas

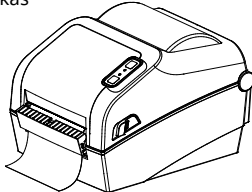

1 Automatinis pjaustytuvas

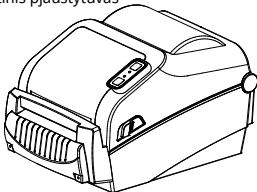



Стандартен модел



Модел с LCD

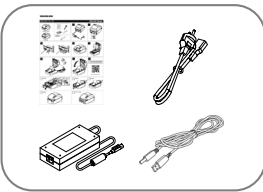

Опция

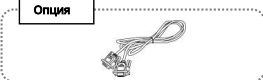

1

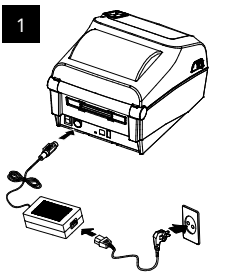

2

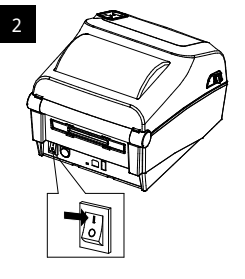

3

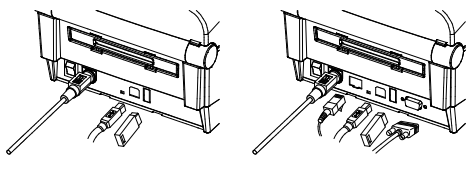

4

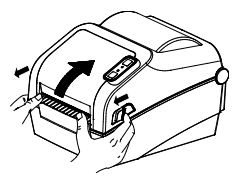

5

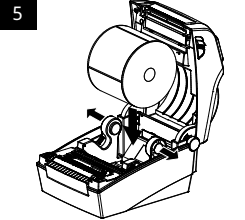

6

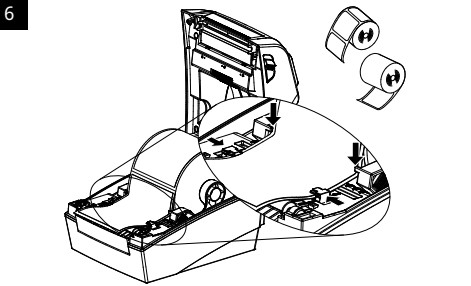

7

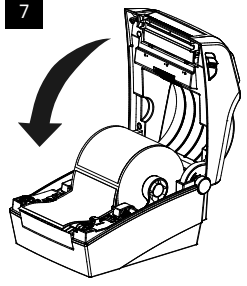

8

За да изгледите повече информация,
посетете уебсайта на BIXOLON.



1 Отлепащо устройство

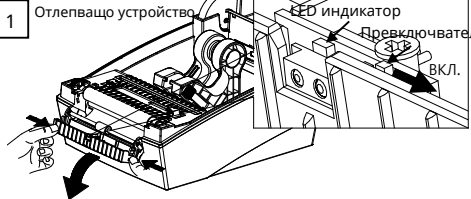

2 Отлепащо устройство

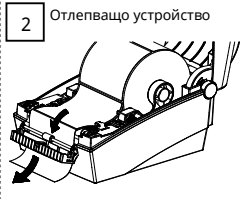

3 Отлепащо устройство

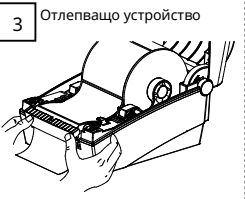

4 Отлепащо устройство



1 Автоматично отрязване





ІСПЕЇМАЇ ІР ПЕРСПЕЇМАЇ

Apibūdinama kaip naudotojo mirtis, fiziniai sužalojimai, dideli finansiniai nuostoliai, duomenų sugadinimas ir kt.

Prie vieno maitinimo lizdo neprijunkite kelių gaminių, arba nejunkite jų, jei lizdas yra sugedęs. Naudokite tik žemintus elektros lizdus, atitinkančius pramonės standartą. **Neatidikimas gali sukelti elektros smūgį arba gaisrą.**



Naudokite tik autentiškus BIXOLON gaminius. Įmonė neteikia pagalbą po pardavimo dėl sugadintų ar kitų kokybės problemų, su kuriomis gali susidurti padirbti (arba atnaujinti) gaminiai.



Pernely nenelkite ir neįtemptkite maitinimo laido. Saugiai įstumkite maitinimo laidą iki galo į maitinimo lizdą, kad jis neatslasintų. Atjungdami laidą nuo maitinimo lizdo būtina tvirtai laikyti jį už laido. Neišimkite maitinimo laido, kol gaminyje nesusijungs. **Neatidikimas gali sukelti elektros smūgį arba gaisrą.**



Mažius priedus ar kitas pakavimo medžiagas laikykite atokiau nuo mažų vaikų. Saugokitės pavojus užspringti. **Neatidikimas su gaminiu galite susidurti, todėl gali tapti skubiai kreiptis į gydytoją.**



Saugykite, kad prie maitinimo laido ir lizdo nepatektų skysčių. Jei ant maitinimo laidų patekė medžiagos, nuvalykite sausu skudurėliu. **Neatidikimas gali sukelti elektros smūgį arba gaisrą.**



Nelaiskite, kad gaminį pažeistų sunkūs daiktai. **Neatidikimas gali sukelti elektros smūgį arba gaisrą.**



Jei gaminyje skleidžia keistas garsas, degėsių, kvapą arba dūmus, nedelsdami išjunkite maitinimą ir atjunkite maitinimo laidą. Jei gaminyje nuvirta arba buvo pažeistas jo šilum, nedelsdami išjunkite maitinimą ir atjunkite maitinimo laidą. Nelaiskite produktų patirti smūgius. **Dėl to gali būti pažeistas gaminyje arba kiti gaisras.**



Gaminį montuokite gerai vėdinamoje vietoje. Laikydami jį tam tikru atstumu nuo sienos. Įrengus gaminį tam tikroje vietoje, kurovis yra per didelis dulkių, drėgmės ir temperatūros svyravimų kiekis, arba naudojant gaminius elektros maitinimo sąlygomis, spraudžiamais gali būti sugadinti. Vidinių sąrašais paskelbtoms temperatūroms gali sukelti gaisrą. **Įdomiai kreiptis į pirkimo vietą, jei nesate šitai dėl produkto patalpinimo.**



Gaminį sumontuokite fiksuotoje vietoje, kad jis nepavirsčiau judančiam gaminį. Išjunkite maitinimą ir atjunkite visus prijungtus kabelius, įskaitant maitinimo laidą. **Kitu atveju, tai gali sugadinti gaminį.**



Niekada savarankiškai neardykite, neremontuokite ir nemodifikuokite gaminio, nes garantija nustos galioti. **Jei reikia atlikti remontą, kreipkitės į pirminę pirkimo vietą.**



Nelaiskite jokioms pašalinėms medžiagoms patekti ant produkto. Ant gaminio nedėkite sunkių daiktų, skysčių ar metalų. **Dėl to gali būti pažeistas gaminyje arba kiti gaisras.**



Jei su gaminiu kilsite problemų, kreipkitės į pirminę pirkimo vietą arba | BIXOLON svetainės gaminio remonto puslapį (www.bixolon.com).



ПРЕДУПРЕЖДЕНИЕ И ВНИМАНИЕ

Обозначает риск от смерти, физических повреждений, серьезных финансовых потерь, ущерба на данн.т.н., които могат да бъдат причинени на потребителя.

Не свързвайте няколко продукта към един-единствен или повреден електрически контакт. Използвайте само заземени електрически контакти, които отговарят на стандартите. **Неспазването на това предупреждение може да доведе до токов удар или пожар.**



Използвайте само оригинални продукти на BIXOLON. Компанията не осигурява гаранционен ремонт на повреден или друг дефектен, които могат да възникнат при употреба на фалшиви (или възстановени) продукти.



Не отгазвайте и не опашайте произведено зареждаща кабел. Натиснете зареждаща кабел докрай в контакта, за да не остане разкобен. Увещаите стабилно щепсел, когато го изваждате от контакта. Не използвайте зареждаща кабел, докато продуктът работи. **Неспазването на това предупреждение може да доведе до токов удар или пожар.**



Дръжте малите детски арити други опасовъчни материали далеч от макин деца. Внимайте: опасност от задушване. **Неправилно борване с продукта може да доведе до нараняване, които да изискват спешна медицинска помощ.**



Съхранявайте тенчостите далеч от зареждаща кабел и контакта. Ако върху зареждащите кабел и попаднали вода, избършете в суха кърпа. **Неспазването на това предупреждение може да доведе до токов удар или пожар.**



Не допускайте продуктът да бъде повреден от тежки предмети. **Неспазването на това предупреждение може да доведе до токов удар или пожар.**



Ако продуктът издава стрепен звук, мигрира на изгорело или дим, незабавно изключете зареждането и извадете щепсела от контакта. Ако изгответе продукта или външната му част бъде повредена, незабавно изключете зареждането и извадете щепсела от контакта. Не подлагайте продукта на сътресения. **Това може да доведе до повреда на продукта или до пожар.**



Исталайте продукта на място с добра вентилация и на достатъчно разстояние от стени. Инсталирайте на примера в среда, в която има вероятност от произволно зареждане, аорта и колебания в температурата, или подлагането на примера на претонално интензивна употреба може да доведе до повреда. Подлагането на извършване температурна мена да предизвика пожар. Свържете се с търговеца, от който сте закупили продукта, ако не сте сигурни как да разположите продукта.



Поставяте продукта на фиксирано място, за да предотвратите преобръщането му. Когато премествате продукта, изключете зареждането и изключете всички свързани кабелни, включително и зареждаща кабел. **В тропически случай продуктът може да бъде повреден.**



Никога не разглобявайте, не ремонтирайте и не модифицирайте продукта самостоятелно, тъй като това ще аннулира гаранцията. **При необходимост от ремонт се обрънете към търговеца, от който сте закупили продукта.**



Не допускайте в продукта да попадат чужди вещества. Не поставяйте тежки предмети, тенчостии или метали върху продукта. **Това може да доведе до повреда на продукта или до пожар.**





Ако възникне проблем с продукта, се свържете с търговеца, от който сте го закупили или се свържете с нас чрез страницата за ремонт на продуктите на уебсайта на BIXOLON (www.bixolon.com).



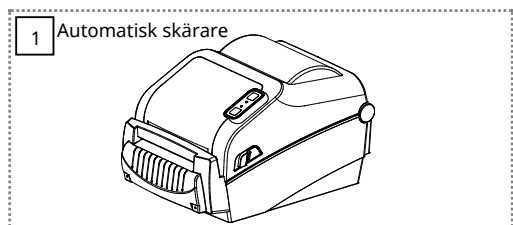
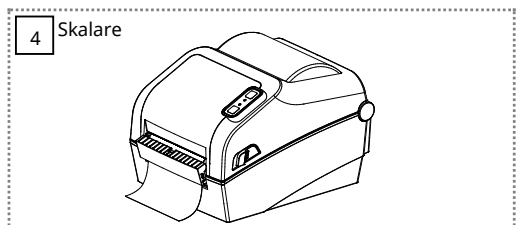
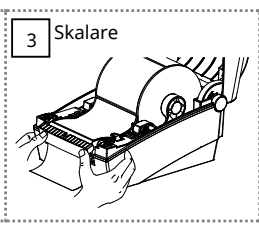
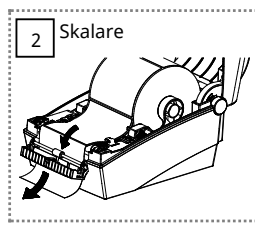
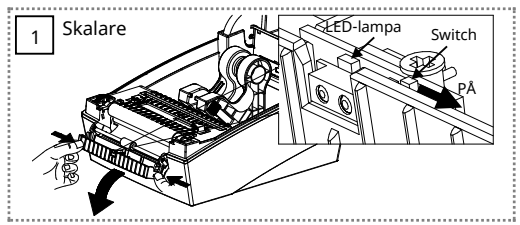
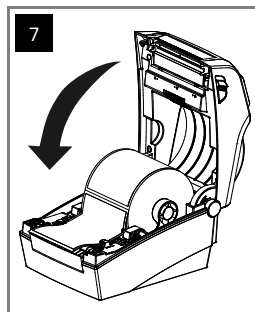
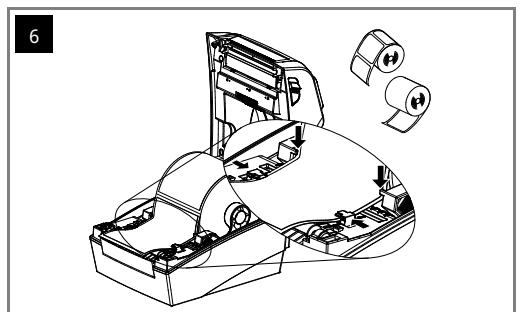
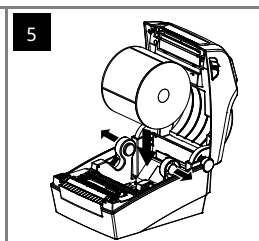
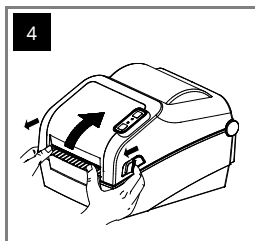
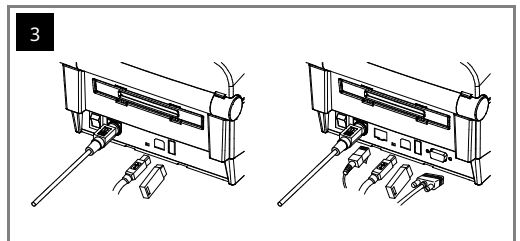
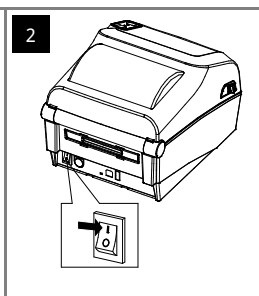
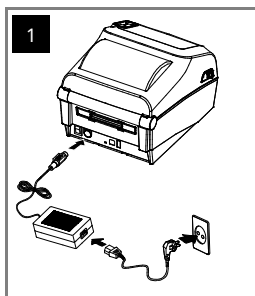
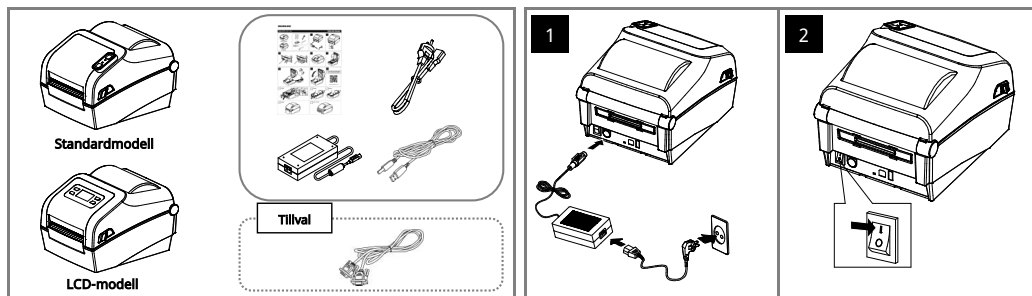

Lituanian

Bulgarian

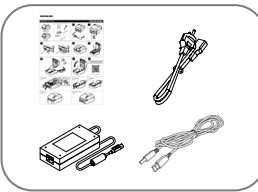
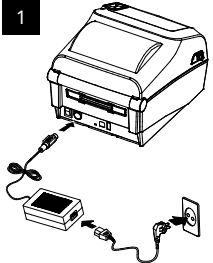
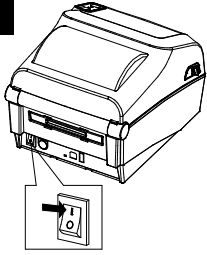

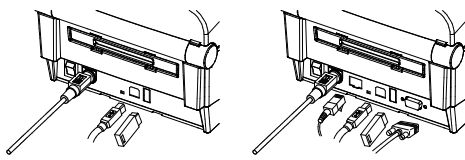
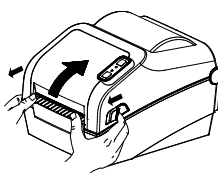
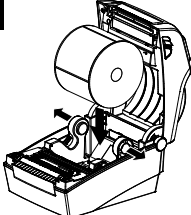
 <p>Modelo estándar</p>  <p>Modelo LCD</p>	 <p>Opción</p>	<p>1</p> 	<p>2</p> 
------------------------------------------------------------------------------------------------------------------------------------------------------------------------------------------------------------	-------------------------------------------------------------------------------------------------	--------------------------------------------------------------------------------------------	---------------------------------------------------------------------------------------------

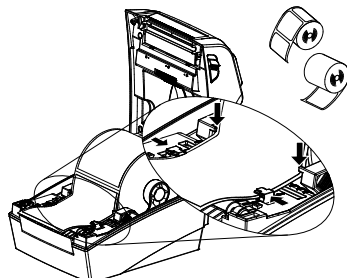
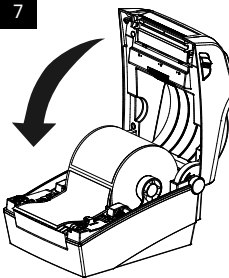
<p>3</p> 	<p>4</p> 	<p>5</p> 
-------------------------------------------------------------------------------------------	--------------------------------------------------------------------------------------------	---------------------------------------------------------------------------------------------

<p>6</p> 	<p>7</p> 	<p>8</p> <p>Para descargar más información, visite el sitio web de BIXOLON.</p> 
---------------------------------------------------------------------------------------------	---------------------------------------------------------------------------------------------	--------------------------------------------------------------------------------------------------------------------------------------------------------------------

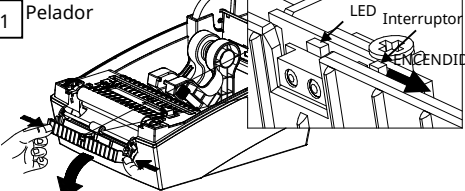
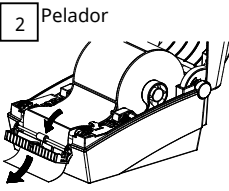
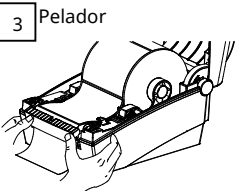
<p>1 Pelador</p>  <p>LED Interruptor ENCENDIDO</p>	<p>2 Pelador</p> 	<p>3 Pelador</p> 
--------------------------------------------------------------------------------------------------------------------------------------	------------------------------------------------------------------------------------------------------	-------------------------------------------------------------------------------------------------------

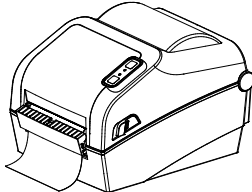
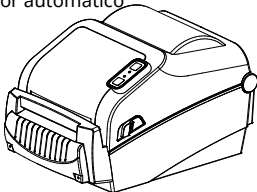
<p>4 Pelador</p> 	<p>1 Cortador automático</p> 
------------------------------------------------------------------------------------------------------	------------------------------------------------------------------------------------------------------------------



VARNING OCH FÖRSIKTIGHET

Beskrivs som dödsfall, fysiska skador, allvarig ekonomiska förlust och skada på data etc. som kan orsakas användaren.



ADVERTENCIA Y PRECAUCIÓN

Se describe como muerte, lesiones físicas, pérdidas financieras graves y daños a los datos, etc., que puede sufrir el usuario.

Anslut inte flera produkter till samma, eller trasiga eluttag. Använd endast jordade eluttag som uppfyller branschstandarden. **Undermåliga eluttag kan orsaka elektriska stötar eller brand.**



Endast ändrat äkta BXOLON-produkter. **Företaget kommer inte att tillhandahålla support eller försäljning för skadade produkter eller andra kvalitetsproblem på eventuella falska (eller reparerade) produkter.**



No conecte varios productos a una toma de corriente única o defectuosa. Utilice únicamente tomas de corriente con conexión a tierra que cumplan con los estándares de la industria. **El incumplimiento puede provocar descargas eléctricas o incendios.**



Utilice únicamente productos auténticos de BXOLON. **La empresa no proporcionará soporte posventa en caso de daños u otros problemas de calidad en los que pueda incurrir cualquier producto falso (o recondicionado).**



Böj och belastar inte strömladden för hårt. Tryck in strömladden ordentligt i eluttaget, så att den inte sitter löst. Håll ordentligt i sladden när du tar ut den från eluttaget. Ta inte ut strömladden medan produkten används. **Undermåliga eluttag kan orsaka elektriska stötar eller brand.**



Håll små tillbehör och förpackningsmaterial borta från små barn. Varning: kvävningssrisk. **Felaktig hantering av produkten kan orsaka skador som kan kräva akutvård.**



No doble ni fuerce excesivamente el cable de alimentación. Empaque con seguridad el cable de alimentación hasta el fondo en la toma de corriente para que no quede suelto. Asegúrese de sujetar el cable con fuerza al separarlo de la toma de corriente. No retire el cable de alimentación mientras el producto esté en uso. **El incumplimiento puede provocar descargas eléctricas o incendios.**



Mantenga los accesorios pequeños u otros materiales de embalaje fuera del alcance de los niños pequeños. Cuidado: peligro de asfixia. **El mal manejo del producto puede provocar lesiones que pueden requerir atención médica urgente.**



Håll vätskor borta från strömladdan och uttaget. Torka av med en torr trasa om strömladdan blir smutsig. **Undermåliga eluttag kan orsaka elektriska stötar eller brand.**



Låt inte produkten skadas av tunga föremål. **Undermåliga eluttag kan orsaka elektriska stötar eller brand.**



Mantenga el exceso de líquidos alejado del cable de alimentación y de la toma. Si se manchan los cables de alimentación, límpielos con un paño seco. **El incumplimiento puede provocar descargas eléctricas o incendios.**



No permita que el producto se dañe con objetos pesados. **El incumplimiento puede provocar descargas eléctricas o incendios.**



Om produkten ager underligt ljud, rökutsläpp eller synlig rök skall du stänga av strömmen omedelbart, och koppla ur strömladdan. Om produkten tappas eller dess sidor skadas skall strömmen stängas av omedelbart och strömladdan dras ur. **Låt inte produkten för stötar. Detta kan orsaka skador på produkten eller brand.**



Installera produkten väl venterat, genom att placera den på ett visst avstånd från väggen. Om produkten installeras på en plats med mycket damm, fukt och temperaturavslutningar, eller om produkten används i extremt varma eller kalla miljöer, kan detta orsaka skador. **Kontakta alltid återförsäljaren om du är osäker på placering av produkten.**



Si el producto emite un sonido extraño, abre o quemado o humo, apáguelo inmediatamente y desenchufe el cable de alimentación. Si el producto se cae o su exterior se daña, apáguelo y inmediatamente víseseñuche el cable de alimentación. No someta el producto a golpes. **Esto podría causar daños al producto o un incendio.**



Instale el producto en un área bien ventilada manteniéndolo a una cierta distancia de la pared. Instalar el producto en determinados entornos propensos a polvo excesivo, humedad y fluctuaciones de temperatura o someter el producto a un uso extremo puede provocar daños a la impresora. Un aumento de la temperatura interna puede provocar un incendio. **Asegúrese de comunicarse con el lugar de compra o el más seguro de la ubicación del producto.**



Installera produkten på en stadig yta så att den inte välter. Om produkten flyttas skall strömmen stängas av, och alla anslutna kablar, inklusive strömladdan, kopplas ur. **Detta kan annars skada produkten.**



Demontera, reparera eller modifiera aldrig produkten själv, eftersom garantin då blir ogiltig. **Om produkten behöver repareras skall du kontakta den ursprungliga återförsäljaren.**



Instale el producto en un lugar fijo para evitar que se vuelte. Cuando mueva el producto, apáguelo y desconecte todos los cables conectados, incluido el cable de alimentación. **Puede dañar el producto.**



Nunca desmonte, repare o modifique el producto de forma independiente, ya que la garantía dejará de ser válida. **Cuando sea necesario una reparación, comuníquese con el lugar de compra original.**



Låt inga främmande ämnen tränga in i produkten. Placera inte tunga föremål, vätskor eller metaller på produkten. **Detta kan orsaka skador på produkten eller brand.**



Om det uppstår problem med produkten ber vi dig kontakta den ursprungliga återförsäljaren, eller använde BXOLON-webbplatsens sida för reparation av produkter (www.bxolon.com).



No deje que ninguna sustancia extraña entre en el producto. No coloque objetos pesados, líquidos o metales sobre el producto. **Esto podría causar daños al producto o un incendio.**



Si hay un problema con el producto, comuníquese con el lugar de compra original o a través de la página de reparación del producto del sitio web de BXOLON (www.bxolon.com).





Svensh

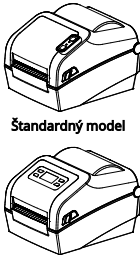
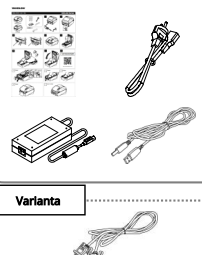
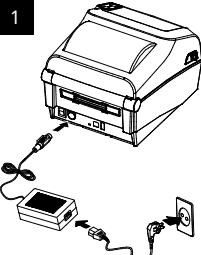
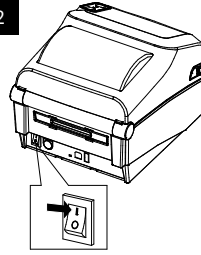

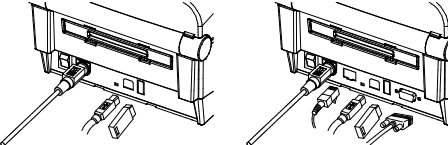
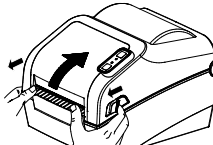
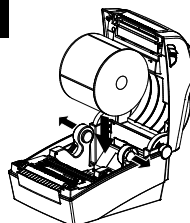
Spanish

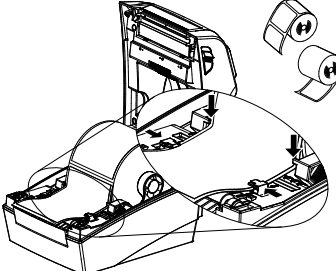
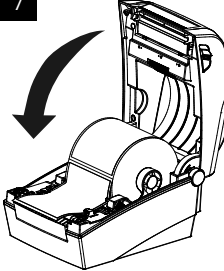
 <p>Standardný model</p> <p>Model LCD</p>	 <p>Varianta</p>	<p>1</p> 	<p>2</p> 
---------------------------------------------------------------------------------------------------------------------------	---------------------------------------------------------------------------------------------------	--------------------------------------------------------------------------------------------	---------------------------------------------------------------------------------------------

<p>3</p> 	<p>4</p> 	<p>5</p> 
-------------------------------------------------------------------------------------------	--------------------------------------------------------------------------------------------	---------------------------------------------------------------------------------------------

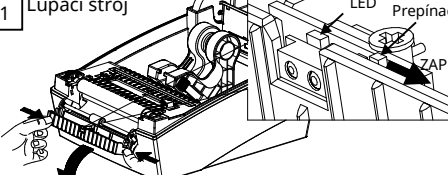
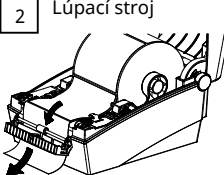
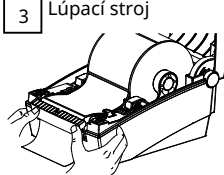

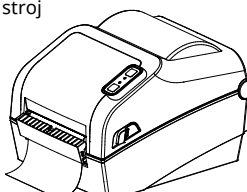
<p>6</p> 	<p>7</p> 	<p>8</p> <p>Ak si chcete stiahnuť viac informácií, navštívte webovú stránku spoločnosti BIXOLON.</p> 
---------------------------------------------------------------------------------------------	---------------------------------------------------------------------------------------------	----------------------------------------------------------------------------------------------------------------------------------------------------------------------------------------

<p>1</p> <p>Lúpací stroj</p> 	<p>2</p> <p>Lúpací stroj</p> 	<p>3</p> <p>Lúpací stroj</p> 
-----------------------------------------------------------------------------------------------------------------	------------------------------------------------------------------------------------------------------------------	-------------------------------------------------------------------------------------------------------------------

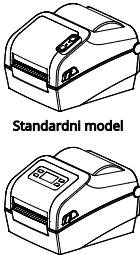
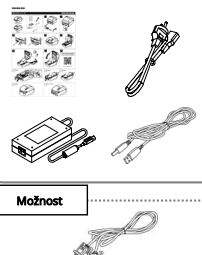
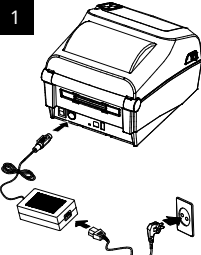
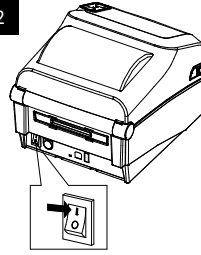

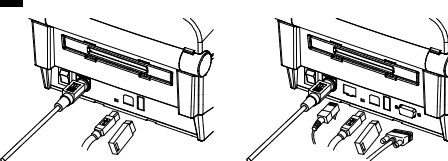
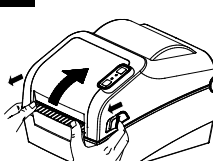
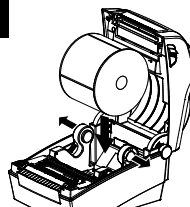
<p>4</p> <p>Lúpací stroj</p> 	<p>1</p> <p>Automatický rezač</p> 
------------------------------------------------------------------------------------------------------------------	-----------------------------------------------------------------------------------------------------------------------

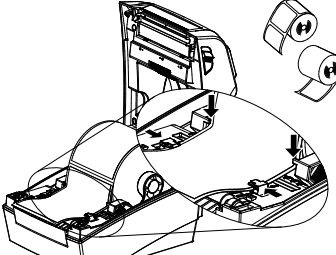
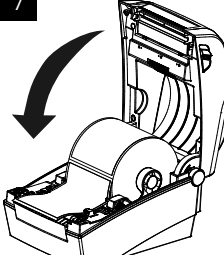
 <p>Standardni model</p> <p>Model LCD</p>	 <p>Možnost</p>	<p>1</p> 	<p>2</p> 
---------------------------------------------------------------------------------------------------------------------------	--------------------------------------------------------------------------------------------------	--------------------------------------------------------------------------------------------	---------------------------------------------------------------------------------------------

<p>3</p> 	<p>4</p> 	<p>5</p> 
-------------------------------------------------------------------------------------------	--------------------------------------------------------------------------------------------	---------------------------------------------------------------------------------------------

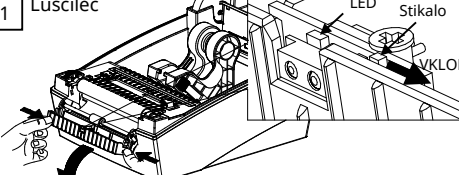
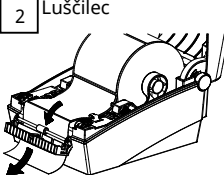
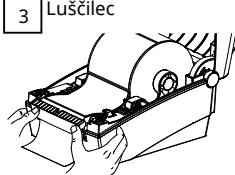
<p>6</p> 	<p>7</p> 	<p>8</p> <p>Če želite prenesti več informacij, obiščite spletno mesto BIXOLON.</p> 
---------------------------------------------------------------------------------------------	---------------------------------------------------------------------------------------------	----------------------------------------------------------------------------------------------------------------------------------------------------------------------

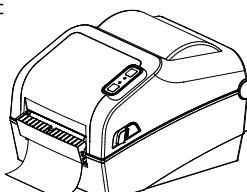
<p>1 Luščilec</p>  <p>LED Stikalo VKLOP</p>	<p>2 Luščilec</p> 	<p>3 Luščilec</p> 
-------------------------------------------------------------------------------------------------------------------------------	-------------------------------------------------------------------------------------------------------	--------------------------------------------------------------------------------------------------------

<p>4 Luščilec</p> 	<p>1 Samodejni rezalnik</p> 
-------------------------------------------------------------------------------------------------------	-----------------------------------------------------------------------------------------------------------------

VAROVANIE A UPOZORNENIE



Je opísaný ako smrť, fyzické zranenia, vážne finančné straty, poškodenie údajov atď., ktoré môžu byť spôsobené používateľovi.

Nepríključajte viaceré výrobkov do jednej alebo chýbnej elektrickej zásuvky. Používajte iba uzemnené elektrické zásuvky, ktoré spĺňajú normu odvetvia. **Nedodržanie pravidiel môže spôsobiť úraz elektrickým prúdom alebo požiar.**



Používajte iba autentické produkty spoločnosti BIXOLON. Spoločnosť **nedoporučuje poskytovať podporu po predaji v prípade poškodených alebo iných problémov s kvalitou, ktoré môžu vzniknúť falšovaným (alebo renovovaným) výrobkom.**



Napájací kábel nadmerne neohýbajte ani nenamáhajte. Bezpečné zatlačte napájací kábel úplne do elektrickej zásuvky, aby rezaltec voľný. Pri vytváraní kábla z elektrickej zásuvky ho pevné držte. Počas používania výrobku napájací kábel neodkladajte. **Nedodržanie pravidiel môže spôsobiť úraz elektrickým prúdom alebo požiar.**



Malé doplnky alebo iné obalové materiály uchovávať mimo dosahu malých detí. Pozor, nebezpečnosť! **Nepoužívanie materiálu v výrobku môže spôsobiť zranenia, ktoré si môžu vyžadovať naliehavú lekársku pomoc.**



Prebytočné tekutiny uchovávať mimo dosahu napájacieho kábla a zásuvky. Ak je na napájací kábel rozmanitá hmota, utrite suchou handričkou. **Nedodržanie pravidiel môže spôsobiť úraz elektrickým prúdom alebo požiar.**



Nedovoľte, aby bol výrobok poškodený ťažkými predmetmi. **Nedodržanie pravidiel môže spôsobiť úraz elektrickým prúdom alebo požiar.**



Ak výrobok vydáva zvláštny zvuk, zápach pálenia alebo dym, okamžite vypnite napájanie a odpojte napájací kábel. Ak výrobok spadne alebo sa poškodí jeho vonkajšia strana, okamžite vypnite napájanie a odpojte napájací kábel. Nevyzdvíhajte výrobok nárazom. **Mohlo by to spôsobiť poškodenie výrobku alebo požiar.**



Výrobok inštalujte na dobre vetranom mieste tak, že ho budete užívať v určitej vzdialenosti od steny. Inštalácia výrobku v určitých prostrediach, ktoré sú náchylné na nadmernú vlhkosť, ohrev a náplňové výfuky, alebo nerovnomerné používanie výrobku môže spôsobiť jeho poškodenie. Zohľadnením vyššie uvedených teplej môže spôsobiť **požiar. Nezbavujte horľavosť alebo náplň, ak si ruku nie umiestnite na produkt.**



Nainštalujte výrobok na pevné miesto, aby ste zabránili jeho prevráteniu. Pri premiestňovaní výrobku vypnite napájanie a odpojte všetky pripojené káble vrátane napájacieho kábla. **Pratože by to mohlo poškodiť výrobok.**



Produkt nikdy samostatne nerozoberajte, neopravujte ani neupravujte, pretože záruka zanikne. **Ak je potrebná oprava, obráťte sa na pôvodné miesto nákupu.**



Nedovoľte, aby do výrobku vnikli žiadne cudzie látky. Na výrobok neumiestňujte ťažké predmety, kvapaliny ani kovy. **Mohlo by to spôsobiť poškodenie výrobku alebo požiar.**



Ak sa vyskytne problém s produktom, obráťte sa na pôvodné miesto nákupu alebo prostredníctvom stránky opravy produktu na webovej stránke spoločnosti BIXOLON (www.bixolon.com).



OPOZORILO IN PREVIDNOST



To pomeni smrt, telesne poškodenie, hude finančné izgube in poškodbe podatkov itd., ki jih lahko povzroči uporabnik.

Ne priključite več izdelkov na eno ali pokvarjeno višičko. Uporabljajte le uzemnjene višičke, ki ustrezajo industrijskim standardom. **Neupoštevanje navedenega lahko povzroči električni udar ali požiar.**



Uporabljajte samo prístne izdelke družbe BIXOLON. **Poplajte ne bo zagotovo poprodajne podpore za poškodovane izdelke ali druge težave s kakovostjo, ki jih lahko povzročijo ponarejeni (ali obnovljeni) izdelki.**



Napájalnega kábla ne upogibajte ani napenjanje prevé. Napájací kábel dobro posúvajte posvém v elektrickej višičke, da ne ostane rezalček. Počkajte, da kábel ob iztiskánu je vtičnice trno držite. Ne odstránajte napájacieho kábla, ko je izdelek v uporabi. **Neupoštevanje navedeného lahko povzroči elektrický udar ali požiar.**



Majhne dodatke ali drugo embalažo hranite izven dosahu majhných detí. Pozor: nevarnosť! **Nepoužívanie materiálu z izdelkom lahko povzroči telesne poškodenie, ki lahko zahtevajo nujno zdravotnísku pomoc.**



Ne približujte večje količine tekočin napájalnemu káblu in višičke. Če se po napájalnih káblu razmaže snov, jih obristite s sucho šrpo. **Neupoštevanje navedeného lahko povzroči elektrický udar ali požiar.**



Ne dopustite, da bi izdelek poškodovali teškimi predmeti. **Neupoštevanje navedeného lahko povzroči elektrický udar ali požiar.**



Če izdelek oddaja nenavaden zvok, vonj po zdgánem ali dym, takoj izklopite napájanie in iztáknite napájací kábel. Če vam izdelek spadé ali sa poškodúje jeho vonkajšia strana, takoj izklopite napájanie in iztáknite napájací kábel. Izdelek ne izpostavljajte udarcem. **To lahko povzroči poškodenie izdelka ali požiar.**



Izdelek nameštite na dobro prezračenno mesto, pri čemer obratite doščno razdeljilo med izdelkom in steno. Nameštitev izdelka v neustrešne okolje, ki so naprtena in izven menu nastajajo prahu, vlage in temperaturnim nihanjem ali izpostavenosti izdelka elektricni uporabi lahko poškoduje izdelki. **Povzročajo nastajanje temperature lahko povzroči požiar. Če ruku pripravíte gleda nameštite izdelka, sa obratno obrnite na mesto nakupa.**



Izdelek nameštite na fiksno mesto, da preprečite prevrnitev. Pred premikanjem izdelka izklopite napájanie in iztáknite vse príključne káble, vključno z napájalnim káblom. **Če tega ne storita, se izdelek lahko poškodúje.**



Nikoli samostojno ne razstavljajte, popravlajte ali spreminjajte izdelka, ker to izniči garancijo. **Če je potrebno popravilo, se obrnite na prvotno mesto nakupa.**





Preprečite vstop tujih snovi v izdelek. Na izdelek ne postavljajte težkih predmetov, tekočin ali kovin. **To lahko povzroči poškodbe izdelka ali požiar.**



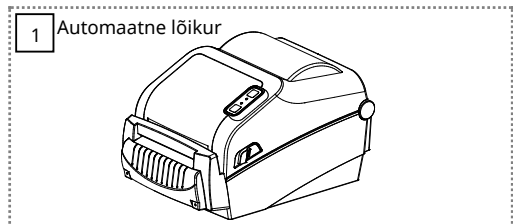
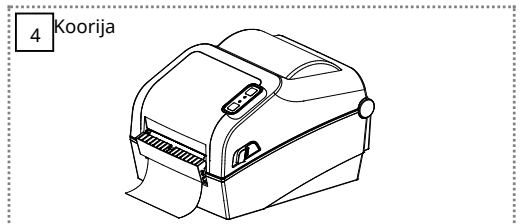
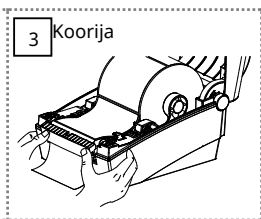
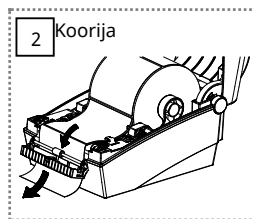
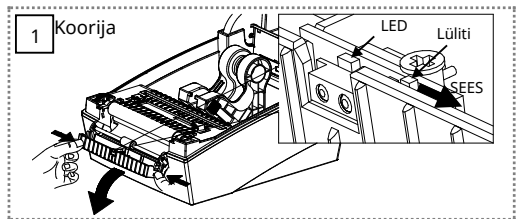
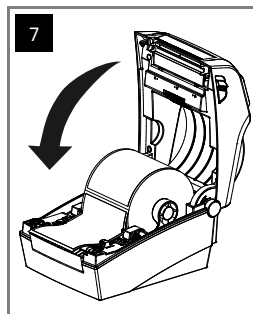
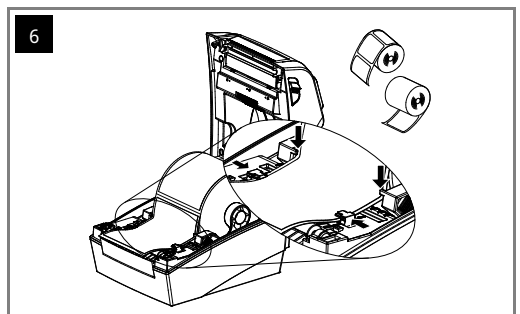
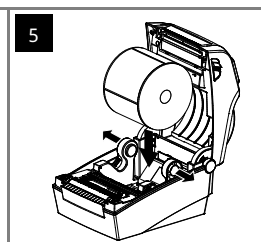
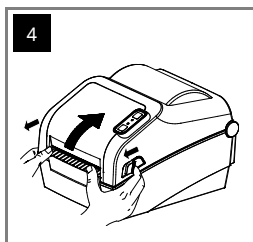
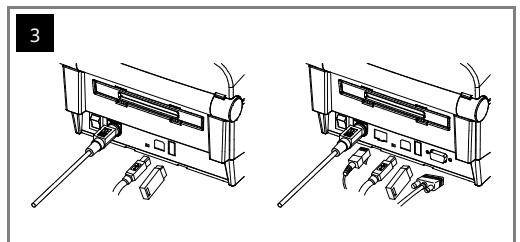
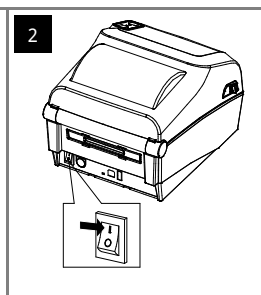
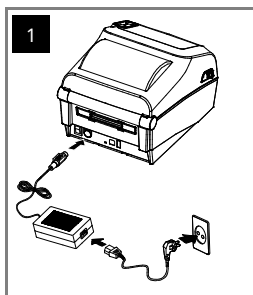
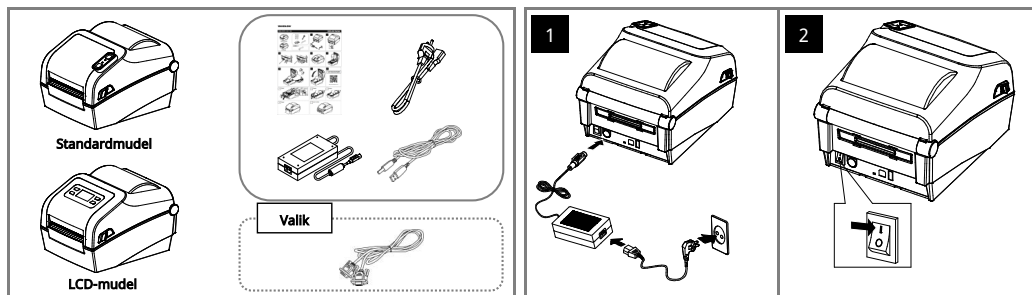

Če pride do težave z izdelkom, se obrnite na prvotno mesto nakupa ali obiščite stran za popravilo izdelkov na spletnem mestu BIXOLON (www.bixolon.com).



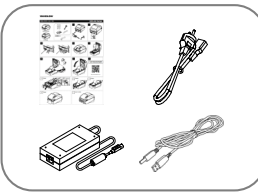
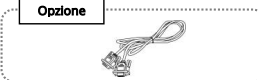
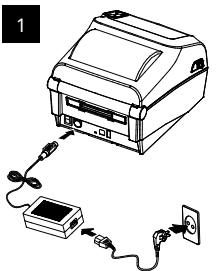
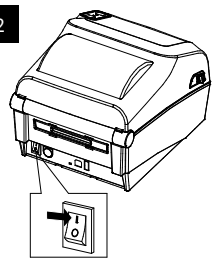

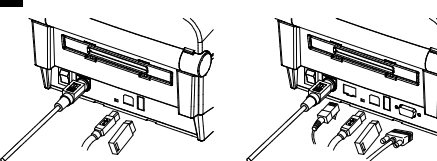
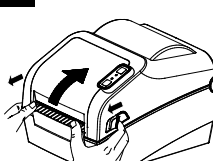
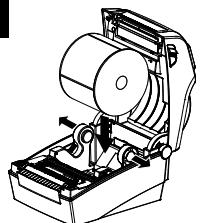
 <p>Modello standard</p>  <p>Modello LCD</p>	 <p>Opzione</p> 	<p>1</p> 	<p>2</p> 
--------------------------------------------------------------------------------------------------------------------------------------------------------------------------------------------------------------	------------------------------------------------------------------------------------------------------------------------------------------------------------------------------------	--------------------------------------------------------------------------------------------	---------------------------------------------------------------------------------------------

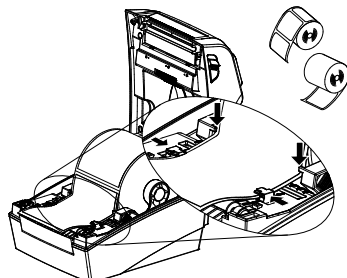
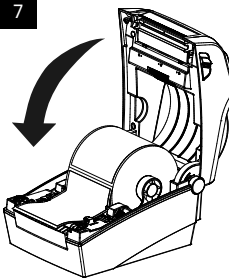
<p>3</p> 	<p>4</p> 	<p>5</p> 
-------------------------------------------------------------------------------------------	--------------------------------------------------------------------------------------------	---------------------------------------------------------------------------------------------

<p>6</p> 	<p>7</p> 	<p>8</p> <p>Per scaricare ulteriori informazioni, visitare il sito web di BIXOLON.</p> 
---------------------------------------------------------------------------------------------	---------------------------------------------------------------------------------------------	---------------------------------------------------------------------------------------------------------------------------------------------------------------------------

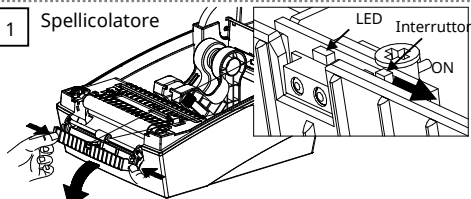
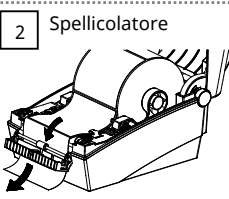
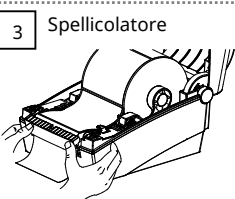
<p>1 Spellicolatore</p>  <p>LED Interruttore</p>	<p>2 Spellicolatore</p> 	<p>3 Spellicolatore</p> 
------------------------------------------------------------------------------------------------------------------------------------	-------------------------------------------------------------------------------------------------------------	--------------------------------------------------------------------------------------------------------------

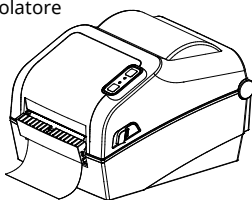
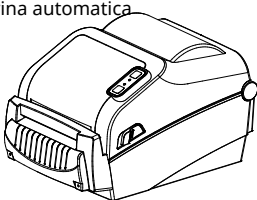
<p>4 Spellicolatore</p> 	<p>1 Taglierina automatica</p> 
-------------------------------------------------------------------------------------------------------------	--------------------------------------------------------------------------------------------------------------------



HOIATUS JA ETTEVAATUST

Seda kirjeldatakse kui surma, kehavigastusi, tõsiseid rahalisi kaotusi, andmete kahjustamist jne, mida kasutaja võib põhjustada.

Ärge ühendage mitut toodet ühe viigase pistikupesaga. Kasutage ainult tööstusstandarditele vastavaid maandatud pistikupesaid. **Mittevastavus võib põhjustada elektrilöögi või tulekahju.**



Kasutage ainult autenteidse BIXOLONI tooteid. **Ettevaet ega muude kvaliteediprobleemide korral, mis võivad tekkida võtistud (või taastatud) toodetel.**



Ärge painutage ega pingutage toitejuhet liigselt. Lükake toitejuhet kindlalt lõpuni pistikupesasse, et see lahti ei jääks. Hoidke juhet kindlalt kinni, kui eemaldate selle soovilõrgust. Ärge eemaldage toitejuhet toote kasutamise ajal. **Mittevastavus võib põhjustada elektrilöögi või tulekahju.**



Hoidke väikesed tarvikud või muud pakematerjalid väikelest eemal. Ettevaatust: **lõhbumisohi! Toote vale käsitamine võib põhjustada vigastusi, mis võivad kujuda lihtet arstiabi.**



Hoidke liigsed vedelikud toitejuhtmest ja pistikupesast eemal. Kui toitejuhtmeele on märgitud ainet, pühkige seda kuiva lapiga. **Mittevastavus võib põhjustada elektrilöögi või tulekahju.**

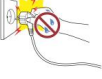

Ärge laske rasketel esemetel toodet kahjustada. **Mittevastavus võib põhjustada elektrilöögi või tulekahju.**



Kui toode eraldab kummalist heli, põlemisõhna või suitsu, lülitage kohe toode välja ja eemaldage toitejuhet. Kui toode kuumub maha või selle väljõng on kahjustatud, lülitage kohe toode välja ja eemaldage toitejuhet. Ärge laske tootel põruda. **See võib kahjustada toodet või põhjustada tulekahju.**



Paigaldage toode hästi ventileeritavasse kohta, hoides seda kindlalt kaugusel seinast. Toote paigaldamine teatud keskkondades, mis on alati liigselt niisked, niiskusele ja temperatuurilõngumisele, või toote airmuutik kasutamise võivad prõmmit kahjustada. Sisemise temperatuuri tõus võib põhjustada tulekahju. **Võite kindlustada ostukohaga ühendust, kui te pole toote paigutusse kindel.**



Paigaldage toode kindlasse kohta, et vältida selle ümberminekut. Toote teisaldamiseks lülitage toode välja ja lahutage kõik ühendatud kaablid, seaditugas toitejuhet. **Kuna see võib toodet kahjustada.**



Ärge kunagi võtke toodet iseseisvalt lahti, parandage ega muutke seda, kuna garantii kaotab kehtivuse. **Kui remont on vajalik, võtke ühendust algse ostukohaga.**



Ärge laske võrkehadel tootesse sattuda. Ärge asetage tootele rasketel esemetel, vedelikele ega metalle. **See võib kahjustada toodet või põhjustada tulekahju.**



Kui toetega on probleeme, võtke ühendust algse ostukohaga või BIXOLONI veebisaiti toote remondilike kaudu (www.bixolon.com).



AVVERTENZA E CAUTELA

Si intende il rischio di morte, lesioni fisiche, gravi perdite economiche, danni ai dati, ecc. che possono essere arrecati all'utente.

Non collegare più di un dispositivo a una singola presa di corrente o a una presa difettosa. Utilizzare solo prese di corrente con messa a terra conformi agli standard industriali. **La mancata osservanza di queste regole può causare scosse elettriche o incendi.**



Utilizzare solo prodotti autentici di BIXOLON. **L'azienda non fornirà assistenza post-vendita per i danni o altri problemi di qualità che potrebbero verificarsi con i prodotti falsi (o ricondizionati).**



Non piegare o sfiorare eccessivamente il cavo di alimentazione. Spingere saldamente il cavo di alimentazione fino in fondo nella presa di corrente per evitare che rimanga allentato. Assicurarsi di tenere il cavo ben saldo quando lo si stacca dalla presa di corrente. Non immergere il cavo di alimentazione mentre il dispositivo è in uso. **La mancata osservanza di queste regole può causare scosse elettriche o incendi.**



Tenere i piccoli accessori o altri materiali di imballaggio lontano dalla portata dei bambini. **Avvertenza: pericolo di soffocamento. L'uso improprio del dispositivo può provocare lesioni che possono richiedere l'intervento urgente di un medico.**



Tenere i liquidi in quantità eccessiva lontano dal cavo di alimentazione e dalla presa di corrente. Eventuali impurità sui cavi di alimentazione devono essere pulite con un panno asciutto. **La mancata osservanza di queste regole può causare scosse elettriche o incendi.**



Non lasciare che il dispositivo venga danneggiato da oggetti pesanti. **La mancata osservanza di queste regole può causare scosse elettriche o incendi.**



Se il dispositivo emette suoni strani, odore di bruciato o fumo, spegnerlo immediatamente e scollegare il cavo di alimentazione. Se il dispositivo cade o viene danneggiato all'esterno, spegnerlo immediatamente e scollegare il cavo di alimentazione. **Non sottoporre il dispositivo a urti. Ciò potrebbe provocare danni al dispositivo o un incendio.**



Installare il dispositivo in un'area ben ventilata, tenendolo a una certa distanza dalla parete. L'installazione della stampante in ambienti umidi e polverosi o in presenza di polvere, umidità o fluttuazioni di temperatura o un uso particolarmente intenso della stessa può provocare danni al dispositivo. Un aumento della temperatura interna può innescare un incendio. **Se non si è sicuri della collocazione del dispositivo, contattare il negoziante in cui viene il stesso acquistato.**



Installare il dispositivo in un luogo fisso per prevenirne il ribaltamento. Quando si sposta il dispositivo, spegnere l'alimentazione e scollegare tutti i cavi collegati, compreso il cavo di alimentazione. **In caso contrario, si rischia di danneggiare il dispositivo.**



Non smontare, riparare o modificare il prodotto per conto proprio, poiché ciò farebbe decadere la garanzia. **Qualora si renda necessaria una riparazione, rivolgersi al rivenditore originale.**



Non far penetrare sostanze estranee nel dispositivo. Non collocare oggetti pesanti, liquidi o metalli sul dispositivo. **Ciò potrebbe provocare danni al dispositivo o un incendio.**





In caso di problemi con il dispositivo, contattare il rivenditore originale o la pagina di assistenza tecnica del sito web (www.bixolon.com).

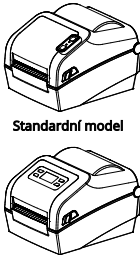
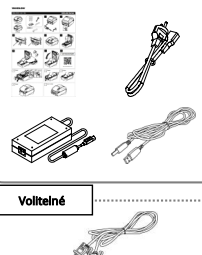
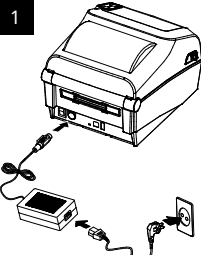
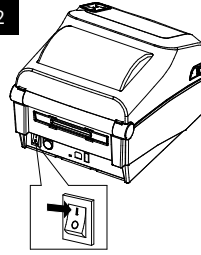

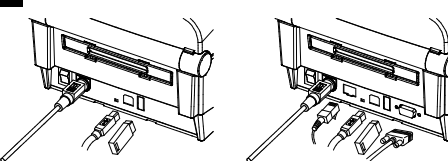
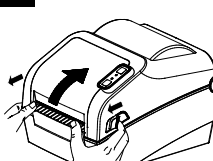
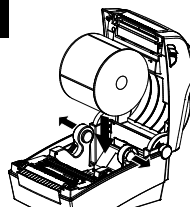

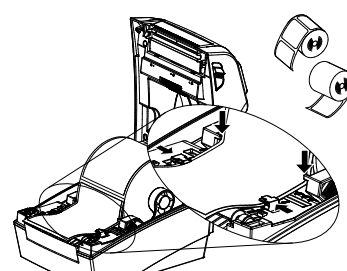
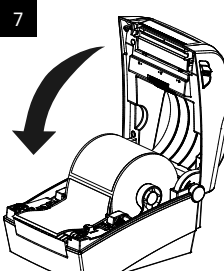
 <p>Standardní model</p> <p>Model s LCD</p>	 <p>Volitelné</p>	<p>1</p> 	<p>2</p> 
-----------------------------------------------------------------------------------------------------------------------------	----------------------------------------------------------------------------------------------------	--------------------------------------------------------------------------------------------	---------------------------------------------------------------------------------------------

<p>3</p> 	<p>4</p> 	<p>5</p> 
-------------------------------------------------------------------------------------------	--------------------------------------------------------------------------------------------	---------------------------------------------------------------------------------------------

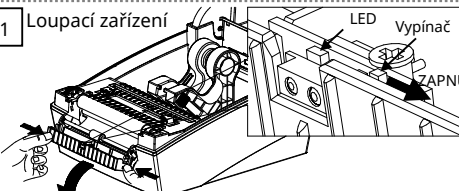
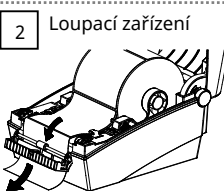
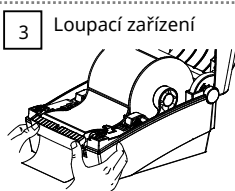
<p>6</p> 	<p>7</p> 	<p>8</p> <p>Pokud chcete stáhnout více informací, navštivte webovou stránku společnosti BIXOLON.</p> 
---------------------------------------------------------------------------------------------	---------------------------------------------------------------------------------------------	----------------------------------------------------------------------------------------------------------------------------------------------------------------------------------------

<p>1</p>  <p>LED Vypínač ZAPNU</p>	<p>2</p> 	<p>3</p> 
----------------------------------------------------------------------------------------------------------------------	----------------------------------------------------------------------------------------------	-----------------------------------------------------------------------------------------------

<p>4</p> 	<p>1</p>  <p>Automatická řezačka</p>
----------------------------------------------------------------------------------------------	-------------------------------------------------------------------------------------------------------------------------



Standardni model



LCD model

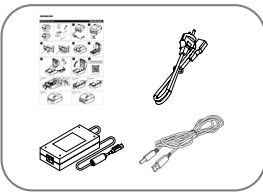

Mogućnost

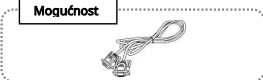

1

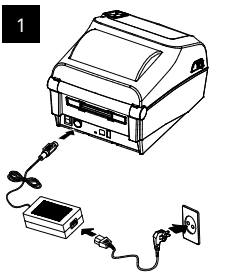

2

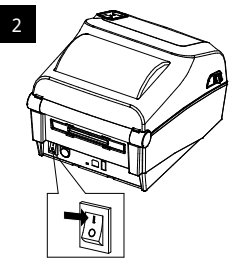

3

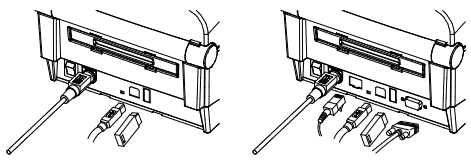

4

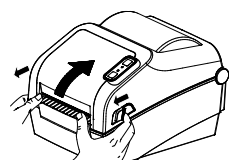

5

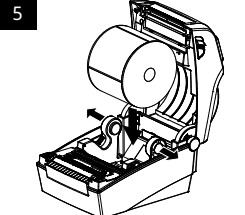

6

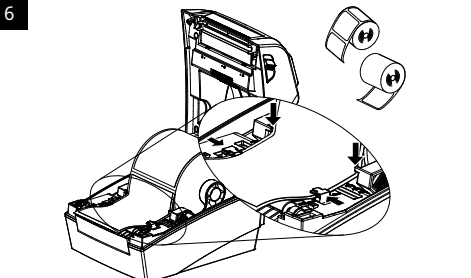

7

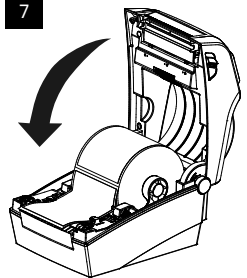

8

Za preuzimanje više informacija posjetite web mjesto BIXOLON.



1 Ljuštilica

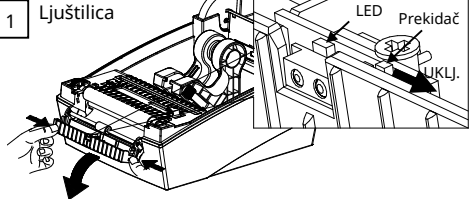

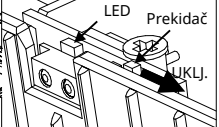

LED Prekidač
UKLJ.

2 Ljuštilica

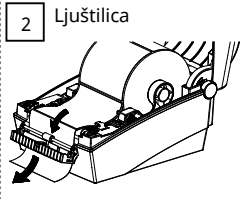

3 Ljuštilica

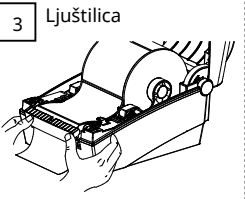

4 Ljuštilica

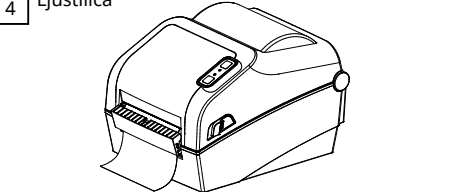

1 Automatski rezač

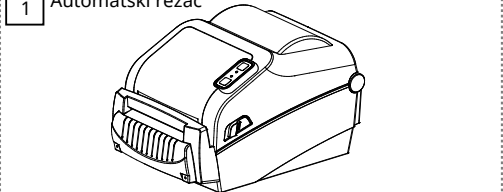

VAROVÁNÍ A UPOZORNĚNÍ



Popisuje se jako smrt, fyzické zranění, vážné finanční ztráty a poškození dat atd., které mohou být způsobeny uživateli.

Nepřipojujte více produktů do jedné nebo vadné zásuvky. Používejte pouze uzemněné zásuvky, které splňují normy daného odvětví. **Nedodržení může způsobit úraz elektrickým proudem nebo požár.**



Používejte pouze autentické produkty společnosti BIXOLON. **Společnost neposkytuje podporu pro prodej v případě poškození nebo jiných problémů s kvalitou, které se mohou vyskytnout u padělaných (nebo nepovolených) výrobků.**



Napájecí kabel příliš neohýbejte ani nenamáhejte. Napájecí kabel bezpečně do zásuvky zasuněte až na doraz, aby rezonance byly. Při odpojování kabelu od zásuvky kabel pevně držte. **Nesprávné napájecí kabel, pokud je produkt v provozu. Nedodržení může způsobit úraz elektrickým proudem nebo požár.**



Drobné příslušenství a obalové materiály uchovávejte mimo dosah malých dětí. **Hrozí nebezpečí uduslení. Při nesprávné manipulaci s produktem může dojít k poranění, které může vyžadovat pomoc lékaře.**



Tekutiny uchovávejte mimo dosah napájecího kabelu a zásuvky. Pokud se na napájecích kabelech objeví nečistoty, otřete je suchým hadříkem. **Nedodržení může způsobit úraz elektrickým proudem nebo požár.**



Nedovolte, aby došlo k poškození produktu těžkými předměty. **Nedodržení může způsobit úraz elektrickým proudem nebo požár.**



Pokud produkt vydává podivný zvuk, zápach spaliny nebo se z něj kouří, okamžitě vypněte napájení a odpojte napájecí kabel. Pokud produkt upadne nebo dojde k poškození jeho vnější části, okamžitě vypněte napájení a odpojte napájecí kabel. **Nevystavte produkt nárazům. Mělo by to způsobit poškození produktu nebo požár.**



Produkt instalujte na dobře větraném místě v dostatečné vzdálenosti od stěny. Instalace produktu v uzavřených prostředích, která jsou nepříznivá k normálnímu výdechu vzduchu, může způsobit nevhodný výhled, nebo vytvoření produktu extrémně nepříznivými podmínkami může způsobit poškození produktu. **Pokud si nejste jisti umístěním produktu, zapojte se v místě jeho zakoupení.**



Produkt instalujte na pevné místo, aby se nepřevrátil. Při přemístění produktu vypněte napájení a odpojte všechny připojené kabely včetně napájecího kabelu. **Mělo by dojít k poškození produktu.**



Nikdy produkt sami nerozebírejte, neopravujte ani neupravujte, protože by tím zanikla záruka. **V případě nutnosti opravy se obraťte na místo, kde jste jej zakoupili.**



Do produktu nesmí proniknout žádné cizí látky. Nepokládejte na produkt těžké předměty, tekutiny ani kovy. **Mělo by to způsobit poškození produktu nebo požár.**



Pokud se vyskytne problém s produktem, obraťte se na místo, kde jste jej zakoupili, nebo na stránku pro opravu produktů na webových stránkách společnosti BIXOLON (www.bixolon.com).



UPOZORENJE I OPREZ



Opisuje se kao smrt, fizičke ozljede, ozbiljni finansijski gubici i oštećenje podataka itd. koji se mogu prouzročiti korisniku.

Ne spajajte više proizvoda na jednu ili nespravnu utičnicu. Koristite samo uzemljene utičnice koje zadovoljavaju industrijski standard. **Neskladnost može uzrokovati strujni udar ili požar.**



Koristite samo autentične proizvode BIXOLON. **Tvrtka neće pružati podršku nakon prodaje za oštećene ili druge probleme s kvalitetom koje mogu izazvati bilo koji lažni (ili obnavljeni) proizvod.**



Nemojte preterano savijati ili zatezati kabel za napajanje. Čvrsto gumite kabel za napajanje do kraja u utičnicu kako ne bi ostao labav. Pazite da čvrsto držite kabel kada ga odvajate od utičnice. Nemojte uklanjati kabel za napajanje dok je proizvod u uporabi. **Neskladnost može uzrokovati strujni udar ili požar.**



Držite male dodatke ili druge materijale za pakiranje dalje od male djece. Oprez: opasnost od gušenja. **Pogrešno rukovanje proizvodom može dovesti do oštećenja koje mogu zahtijevati hitnu liječničku pomoć.**



Držite prekomjerne tekućine podalje od kabela za napajanje i utičnice. Ako je mrlja razmazana po kabelima za napajanje, obristite ih suhom krpom. **Neskladnost može uzrokovati strujni udar ili požar.**

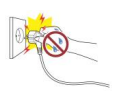

Nemojte dopustiti da se proizvod ošteti teškim predmetima. **Neskladnost može uzrokovati strujni udar ili požar.**



Ako proizvod emitira neobičan zvuk, miris paljive ili dim, odmah isključite napajanje i izvucite kabel za napajanje. Ako proizvod padne ili mu se varijke dio ošteti, odmah isključite napajanje i izvucite kabel za napajanje. **Ne izlažite proizvod udarcima. To bi moglo uzrokovati oštećenje proizvoda ili požar.**



Instalirajte proizvod u dobro prozračenom prostoru odvajajući ga na određenoj mjestu udaljenosti od zida. Ugrađivanje proizvoda u nepropusna okruženja kao su uslova prekomjerne vlažnosti, viski i temperaturne fluktuacije ili stavljanje proizvoda u ekstremnu upotrebu može izazvati požar. **Moguća je opasnost od napetosti koja može izazvati požar. Obavezno koristite odgovarajuće napajanje ako niste sigurni u planiranu instalaciju.**



Postavite proizvod na fiksno mjesto kako biste spriječili njegovo prevrtanje. Kada premještate proizvod, isključite napajanje i odspojte sve spojene kabele, uključujući kabel za napajanje. **Nalma, može oštetiti proizvod.**



Nikada nemojte samostalno rastavljati, popravljati ili modificirati proizvod jer će jamstvo prestati vrijediti. **Ako je potreban popravak, obratite se izvornom mjestu kupnje.**





Ne dopuštajte da strane stvari uđu u proizvod. Ne stavljajte teške predmete, tekućine ili metale na proizvod. **To bi moglo uzrokovati oštećenje proizvoda ili požar.**



Ako postoji problem s proizvodom, obratite se izvornom mjestu kupnje ili putem web mjesta za popravak proizvoda BIXOLON (www.bixolon.com).

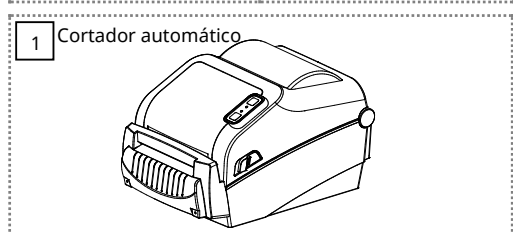
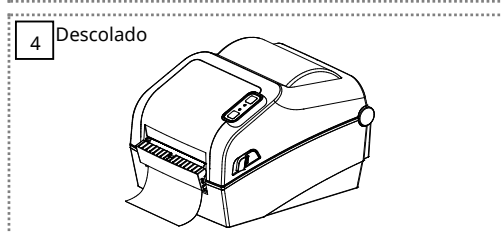
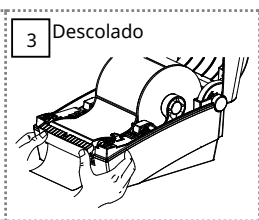
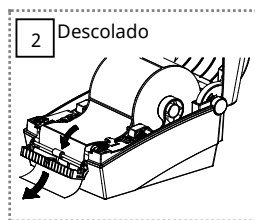
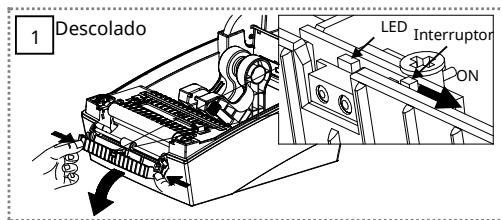
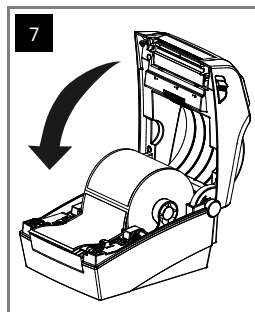
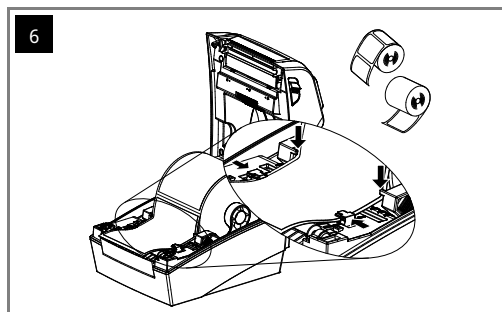
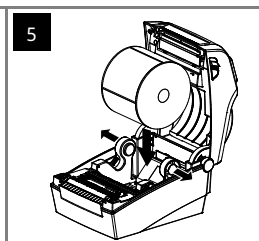
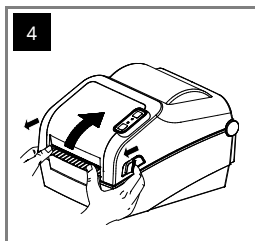
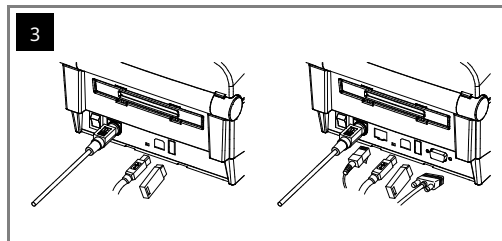
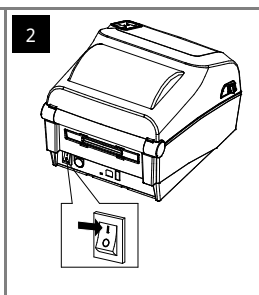
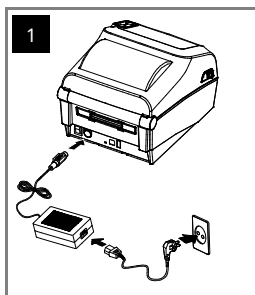
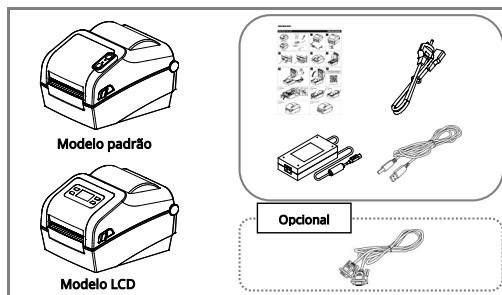





Model standardowy



Model LCD

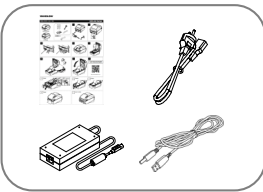

Opcja

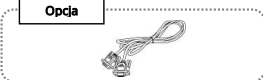

1

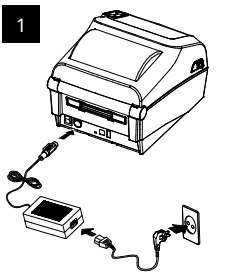

2

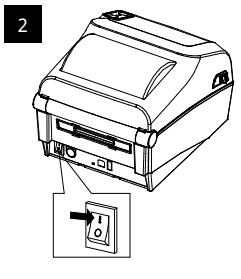

3

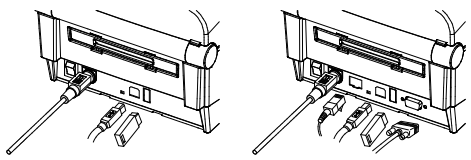

4

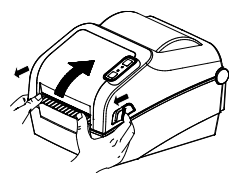

5

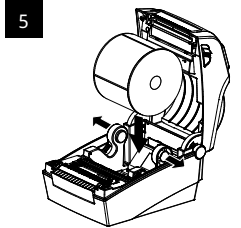

6

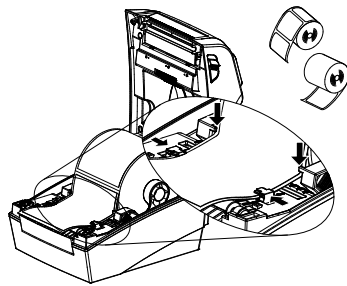

7

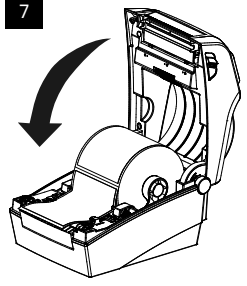

8

W celu uzyskania dalszych informacji zachęcamy do odwiedzenia witryny internetowej firmy BIXOLON.



1 Odklejak

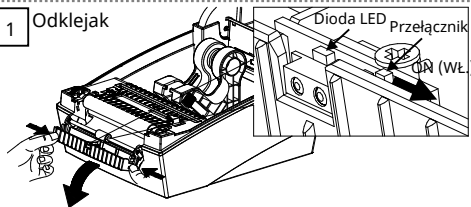

Dioda LED Przełącznik ON (WŁ.)

2 Odklejak

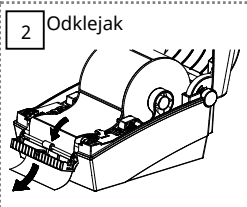

3 Odklejak

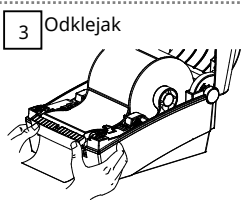

4 Odklejak

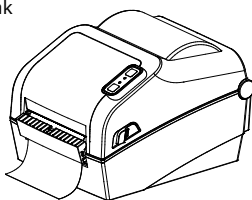

1 Automagiczna

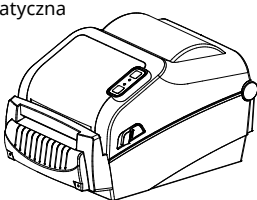



AVISO E CUIDADO

É descrito como situações como morte, ferimentos, prejuízos financeiros de grande monta e danos nos dados, entre outros, que podem ser causados ao utilizador.

Não ligue vários produtos a uma tomada elétrica danificada ou inutilizável. Use apenas tomadas com ligação à terra que cumpram com as normas da indústria. **O desrespeito pelo mencionado anteriormente pode levar ao risco de choques elétricos e incêndio.**



Não dobre ou cause tensões excessivas no cabo de alimentação. Empurre com cuidado o cabo de alimentação totalmente em direção à tomada elétrica, para que a ligação seja segura. Certifique-se de que segura o cabo com firmeza ao separá-lo da tomada elétrica. Não remova o cabo de alimentação enquanto estiver a utilizar o produto. **O desrespeito pelo mencionado anteriormente pode levar ao risco de choques elétricos e incêndio.**



Mantenha líquidos em excesso afastados do cabo de alimentação e da tomada. Se os elementos entrarem em contacto com os cabos de alimentação, limpe-os com um pano seco. **O desrespeito pelo mencionado anteriormente pode levar ao risco de choques elétricos e incêndio.**



Se o produto emitir um som estranho, odor a queimado ou fumo, desligue-o do corrente imediatamente e retire o cabo de alimentação da tomada. Se o produto tiver caído ao solo exterior estiver danificada, desligue-o da corrente imediatamente e retire o cabo de alimentação da tomada. **Não utilize o produto novamente. Tal poderá danificar o produto ou originar um incêndio.**



Instale o produto num local estável, de forma a evitar que este caia. Quando mover o produto, desligue-o da corrente e retire todos os cabos ligados, incluindo o cabo de alimentação. **Isto pode danificar o produto.**



Não permita que nenhuma substância estranha entre dentro do produto. Não coloque objetos pesados, líquidos ou metais sobre o produto. **Tal poderá danificar o produto ou originar um incêndio.**



Use apenas produtos originais da BXOLON. **A empresa não irá fornecer serviço pós-venda por danos ou outros problemas resultantes da utilização de produtos de concorrência (ou reconicionados).**



Mantenha acessórios pequenos ou outros materiais de embalagem afastados de crianças pequenas. Cuidado: perigo de asfixia. **O manuseamento incorreto do produto pode causar ferimentos sucessivos de serem necessários cuidados médicos urgentes.**



Não permita que o produto fique danificado devido a objetos pesados. **O desrespeito pelo mencionado anteriormente pode levar ao risco de choques elétricos e incêndio.**



Instale o produto numa área bem ventilada, mantendo-o a uma certa distância do parede. Instalar o produto em determinados ambientes que são propensos a pó excessivo, humidade e a flutuações de temperatura ou calor ou o produto não se o mesmo pode causar danos à impressora. **Um aumento de temperatura interna pode levar um incêndio. Certifique-se de contactar o local de compra se não tiver certeza sobre a colocação do produto.**



Não desmonte, repare ou altere o produto por iniciativa própria. Ao fazê-lo, irá invalidar a garantia. **Se for necessária uma reparação, contacte o ponto de compra original.**



Se existir um problema com o produto, entre em contacto com o ponto de compra original ou através da página de reparações de produtos do site Web da BXOLON (www.bxolon.com).



OSTRZEŻENIE I PRZESTROGA

Sygnalizuje niebezpieczeństwo śmierci, obrażeń fizycznych, poważnych strat finansowych, uszkodzenia danych itp. dla użytkownika.

Nie podłączaj wielu urządzeń do jednego gniazdzka zasilania lub do wadliwego gniazdzka zasilania. Należy używać wyłącznie uziemionych gniazdek elektrycznych spełniających normy branżowe. **Nieprzestrzeżenie tego zalecenia może spowodować porażenie prądem elektrycznym lub pożar.**



Nie należy nadmiernie zginąć ani naciskać przewodu zasilającego. Przewód zasilający należy wyciągnąć do końca do gniazdzka, aby nie porzucić luty. Podczas odłączania przewodu od gniazda zasilania należy go mocno trzymać. Nie wolno odłączać przewodu zasilającego podczas używania urządzenia. **Nieprzestrzeżenie tego zalecenia może spowodować porażenie prądem elektrycznym lub pożar.**



Nadmiernie ciepły przedmiot należy przechowywać z dala od przewodu zasilającego i gniazdzka. W przypadku zabrudzenia przewodów zasilających należy wytrzeć je suchą szmatką. **Nieprzestrzeżenie tego zalecenia może spowodować porażenie prądem elektrycznym lub pożar.**



Jeżeli z produktu wydobywa się dźwięk odgłos, zapach spalenizny lub dym, należy natychmiast wyłączyć zasilanie i odłączyć przewód zasilający. W przypadku uszkodzenia urządzenia lub uszkodzenia jego obudowy należy natychmiast wyłączyć zasilanie i odłączyć przewód zasilający. **Nie narządź urządzenia na wstrząsy. Mogłyby to spowodować uszkodzenie urządzenia lub pożar.**



Urządzenie należy zainstalować w stałym miejscu, aby zapobiec jego przewróceniu. Podczas przenoszenia urządzenia należy wyłączyć zasilanie i odłączyć wszystkie przewody podłączone do urządzenia, w tym przewód zasilający. **Może to spowodować uszkodzenie urządzenia.**



Nie dopuszczaj do przedostania się ciał obcych do wnętrza urządzenia. Nie umieszczaj na urządzeniu ciężkich przedmiotów, ciężcy ani metali. **Mogłyby to spowodować uszkodzenie urządzenia lub pożar.**



Należy używać wyłącznie oryginalnych produktów firmy BXOLON. **Firma nie zapewnia wsparcia posprzedażowego w przypadku uszkodzeń lub innych problemów związanych z jednostką, które mogą wystąpić w przypadku podrobionych (lub regenerowanych) produktów.**



Drobne akcesoria lub inne materiały opakowaniowe należy przechowywać z dala od małych dzieci. Uwaga: ryzyko zadławienia. **Nieulegające obchodzenie się z urządzeniem może spowodować obrażenia wymagające pilnej pomocy medycznej.**



Nie dopuścić do uszkodzenia urządzenia przez ciężkie przedmioty. **Nieprzestrzeżenie tego zalecenia może spowodować porażenie prądem elektrycznym lub pożar.**



Urządzenie należy zainstalować w dobrze wentylowanym miejscu, w pewnej odległości od ściany. Instalacja produktu w środowisku, w którym występuje nadmierne zapylenie, wilgoć, nadmierne temperatury lub wykłono intensywno użytkowanie urządzenia może spowodować uszkodzenie drutarki lub pożar. **Wzrost temperatury wewnętrznej może wywołać pożar. W razie wystąpienia do do umiarkowania urządzenia należy skontaktować się z punktem sprzedaży.**



Nigdy nie należy samodzielnie demontować, naprawiać ani modyfikować urządzenia, ponieważ spowoduje to utratę gwarancji. **W razie konieczności naprawy należy skontaktować się z oryginalnym miejscem zakupu.**



W razie wystąpienia problemu z produktem należy skontaktować się z oryginalnym miejscem zakupu lub z oddzielnym stronom napraw produktów w witrynie internetowej firmy BXOLON (www.bxolon.com).



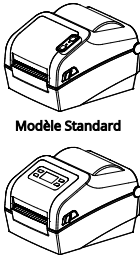
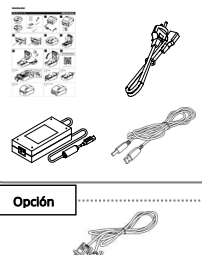
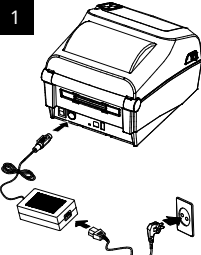
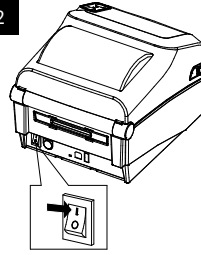

Portuguese

Polish

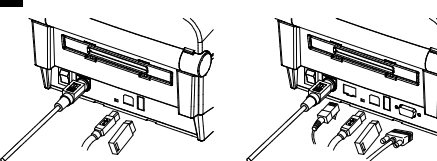
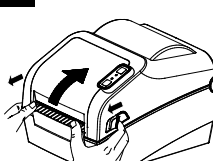
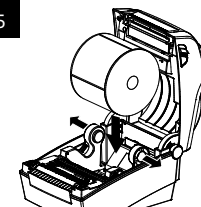
 <p>Modèle Standard</p> <p>Modèle LCD</p>	 <p>Opción</p>	<p>1</p> 	<p>2</p> 
---------------------------------------------------------------------------------------------------------------------------	-------------------------------------------------------------------------------------------------	--------------------------------------------------------------------------------------------	---------------------------------------------------------------------------------------------

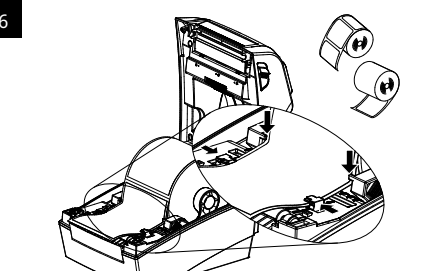
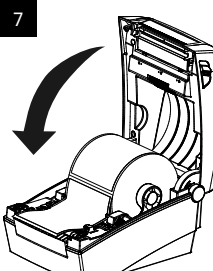
<p>3</p> 	<p>4</p> 	<p>5</p> 
-------------------------------------------------------------------------------------------	--------------------------------------------------------------------------------------------	---------------------------------------------------------------------------------------------

<p>6</p> 	<p>7</p> 	<p>8</p> <p>Pour obtenir plus d'informations, consultez le site web de BIXOLON.</p> 
--------------------------------------------------------------------------------------------	---------------------------------------------------------------------------------------------	-----------------------------------------------------------------------------------------------------------------------------------------------------------------------

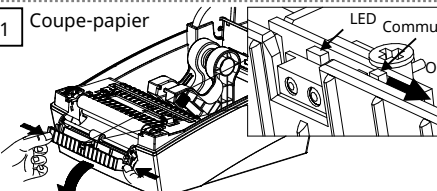
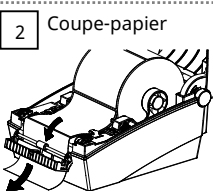
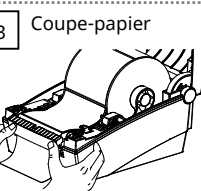
<p>1 Coupe-papier</p>  <p>LED Commutateur</p>	<p>2 Coupe-papier</p> 	<p>3 Coupe-papier</p> 
---------------------------------------------------------------------------------------------------------------------------------	-----------------------------------------------------------------------------------------------------------	------------------------------------------------------------------------------------------------------------

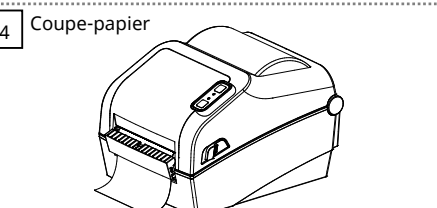
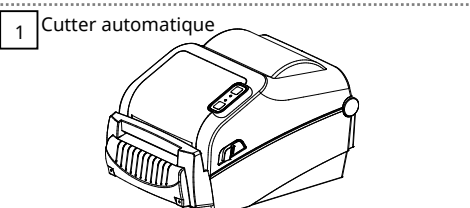
<p>4 Coupe-papier</p> 	<p>1 Cutter automatique</p> 
----------------------------------------------------------------------------------------------------------	------------------------------------------------------------------------------------------------------------------

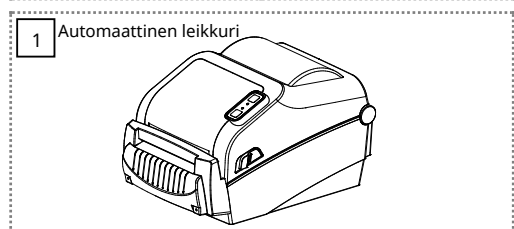
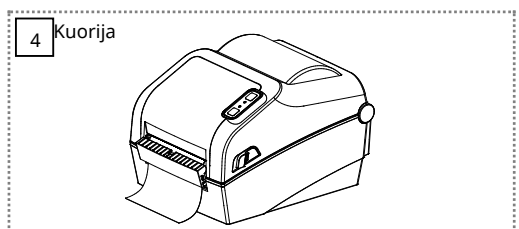
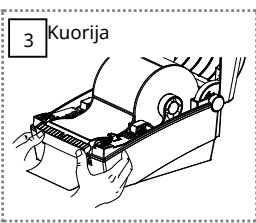
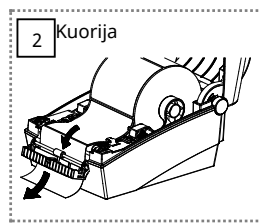
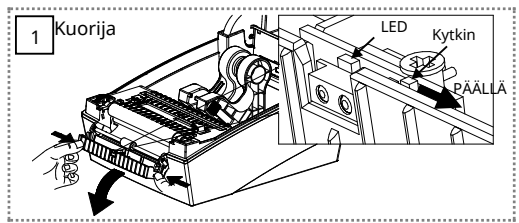
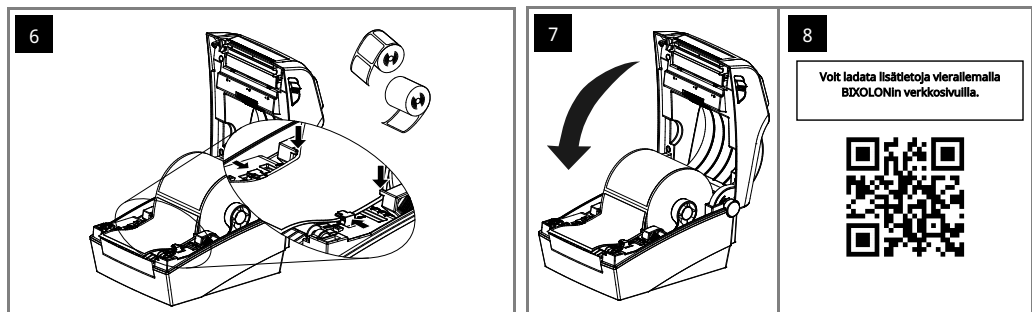
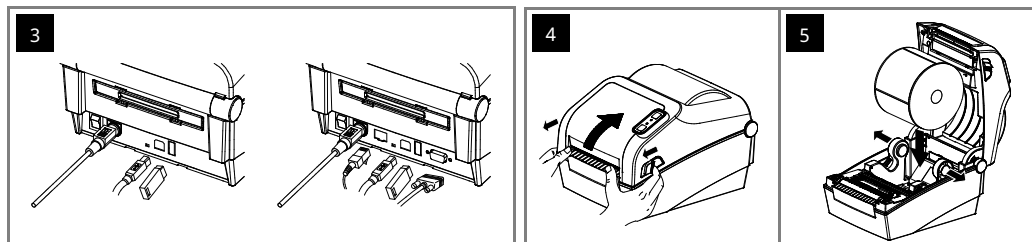
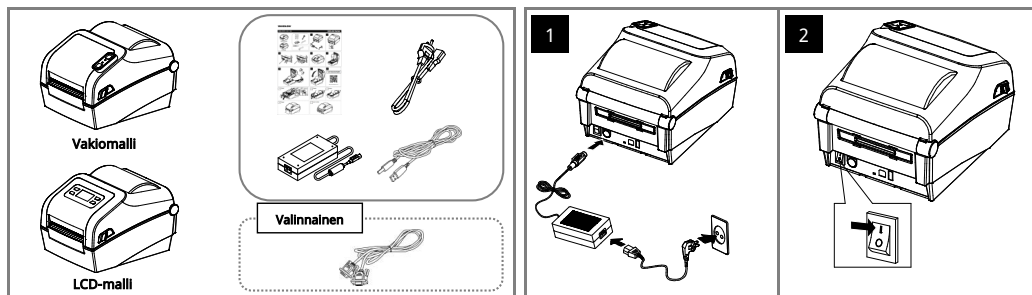



AVERTISSEMENT ET MISE EN GARDE

Cela indique qu'il existe un risque de mort, de blessures corporelles, de pertes financières graves, de dommages aux données, etc. pour l'utilisateur.



VAROITUS JA HUOMIO

Kuuaa kuolemaa, fyysisiä vammoja, vakavia taloudellisia menetyksiä, tietovahinkoja jne., joita käyttäjälle voi aiheutua.

Ne branchez pas plusieurs appareils sur une même prise de courant ou sur une prise défectueuse. N'utilisez que des prises de courant avec mise à la terre conformes aux normes industrielles. **Le non-respect de cette consigne peut causer un choc électrique ou un incendie.**



Utilisez uniquement des produits d'origine BIXOLON. L'entreprise ne fournit pas de service après-vente pour les dommages ou autres problèmes de qualité causés par l'utilisation de produits contrefaits (remis à neuf).



Älä liitä useita tuotteita samaan tai vialliseen pistorasiaan. Käytä vain alan standardin mukaisia maadotettuja pistorasioita. **Määräysten noudattamatta jättäminen voi aiheuttaa sähköiskun tai tulipalon.**



Käytä vain aitoja BIXOLON-tuotteita. Yritys ei tarjoa myynnin jälkeistä tukea vahingossa tai muissa laatuongelmissa, joita väärennetyille (tai kunnostetuille) tuotteille voi aiheutua.



Ne prenez pas ou ne tendez pas de manière excessive le cordon d'alimentation. Évitez fermement le danger d'alimentation à fond dans la prise de courant pour éviter qu'il ne se détache. Veillez à bien tenir le cordon lorsque vous le débranchez de la prise de courant. Ne retirez pas le cordon d'alimentation lorsque le produit est en cours d'utilisation. **Le non-respect de cette consigne peut causer un choc électrique ou un incendie.**



Gardez les petits accessoires ou autres matériaux d'emballage hors de portée des jeunes enfants. Attention : risque d'étrouffement. **Une mauvaise manipulation du produit peut entraîner des blessures, qui nécessitent l'intervention urgente d'un médecin.**



Älä tavuta tai kiristä virtajohtoa liikaa. Työnä virtajohto tavallisesti kokonaan pistorasiaan, jotta se ei jää löysäksi. Varmista, että aiotet tuuletus kiinni johdoton, kun irrotat sen pistorasiasta. **Älä irrota virtajohtoa, kun tuote on käynnissä. Määräysten noudattamatta jättäminen voi aiheuttaa sähköiskun tai tulipalon.**



Pitä pientä tarvikkeita tai muu pakkausmateriaali pois pienten lasten ulottuvilla. Varo: tukahduttamassa. **Tuotteen väärinkäyttö voi aiheuttaa vammoja, joita saattavat vaatia lähtevä lääkärin hoitoa.**



Tenez les liquides à l'écart du cordon d'alimentation et de la prise de courant. Si vous devez nettoyer le cordon d'alimentation, utilisez un chiffon sec. **Le non-respect de cette consigne peut causer un choc électrique ou un incendie.**



Veillez à ce que le produit ne soit pas endommagé par des objets lourds. **Le non-respect de cette consigne peut causer un choc électrique ou un incendie.**



Pitä ylimääräiset nesteet kaukana virtajohtosta ja pistorasiasta. Jos virtajohtoa on tahrintunut aineita, pyyhi se pois kuivalla liinalla. **Määräysten noudattamatta jättäminen voi aiheuttaa sähköiskun tai tulipalon.**



Älä anna painavien esineiden vahingoittaa tuotetta. **Määräysten noudattamatta jättäminen voi aiheuttaa sähköiskun tai tulipalon.**



Si le produit émet un son étrange, une odeur de brûlé ou de la fumée, désignez immédiatement et débranchez le cordon d'alimentation. Si le produit tombe ou si présente des signes de dommages, désignez immédiatement et débranchez le cordon d'alimentation. **Ne saisissez pas le produit de choc. Le non-respect de cette consigne peut causer un choc électrique ou un incendie.**



Installez le produit dans un endroit bien ventilé et le maintenez à une certaine distance du mur. L'installation du produit dans certains environnements sujets à la poussière, à l'humidité et aux variations de température extrêmes ou l'utilisation extrême du produit peuvent endommager l'imprimante. Une augmentation de la température interne peut provoquer un incendie. **Veillez à contacter le lieu d'achat si vous n'êtes pas sûr de l'emplacement du produit.**



Jos tuotteesta kuuluu outoa ääntä, palavaa hajua tai savua, katkaise virta välittömästi ja irrota virtajohto. Jos tuote putoaa tai sen ulkopinta vaurioituu, katkaise virta välittömästi ja irrota virtajohto. **Älä ahistu tuotteen iskulle. Tämä voi aiheuttaa vahinkoa tuotteelle tai tulipalon.**



Asenna tuote hyvin tuuletettuun tilaan ja pidä se tietyllä etäisyydellä seinästä. Tuotteen asentaminen tietyihin ympäristöihin, jotka ovat alttiita kosteudelle, kuumuudelle ja lampotilavaihteluille, tai tuotteen asentaminen aliräyhäiseen käyttöön voi vahingoittaa tuotetta. **Älä koskaan yritä korjata tuotetta, jos olet epävarma tuotteen toiminnasta.**



Installez le produit dans un endroit fixe pour éviter qu'il ne bascule. Lorsque vous déplacez le produit, mettez-le hors tension et débranchez tous les câbles. **Le non-respect de cette consigne peut endommager le produit.**



Ne tentez jamais de démonter, réparer ou modifier le produit vous-même, sous peine d'annuler la garantie. **Si une réparation est nécessaire, contactez votre revendeur.**



Asenna tuote kiinteään paikkaan, jotta se ei pääse kaatumaan. Kun siirrät tuotetta, katkaise virta ja irrota kaikki liitetyt kaapelit, myös virtajohto. **Koska se voi vahingoittaa tuotetta.**



Älä koskaan pura, korjaa tai muuta tuotetta itsenäisesti, sillä takuu raukeaa. **Jos korjaus on tarpeen, ota yhteyttä alkuperäiseen ostospalkkaan.**



Ne laissez pas de substances étrangères pénétrer dans le produit. Ne placez pas d'objets lourds, de liquides ou de métaux sur le produit. **Le non-respect de cette consigne peut causer un choc électrique ou un incendie.**



En cas de problème avec le produit, veuillez contacter le lieu d'achat d'origine ou le page de réparation des produits du site web de BIXOLON (www.bixolon.com).



Älä päästä tuotteeseen mitään vieraita aineita. **Älä aseta tuotteen päälle raskaita esineitä, nesteitä tai metalleja. Tämä voi aiheuttaa vahinkoa tuotteelle tai tulipalon.**



Jos tuotteessa on ongelmia, ota yhteyttä alkuperäiseen ostospalkkaan tai BIXOLONin verkkosivuston tuotekorjussivun kautta (www.bixolon.com).



French

Finnish

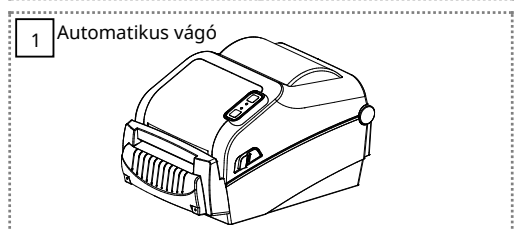
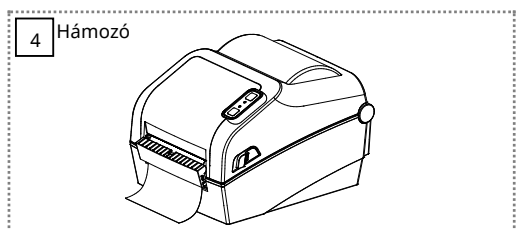
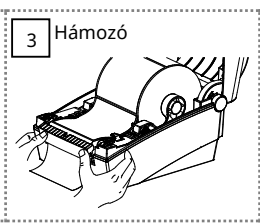
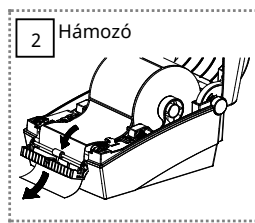
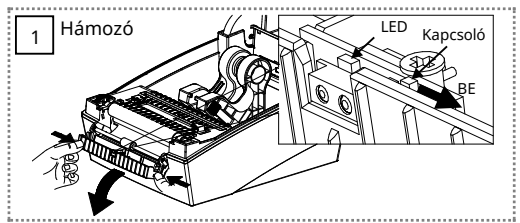
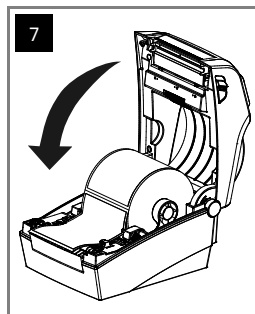
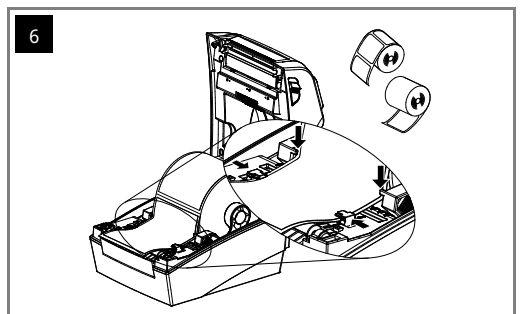
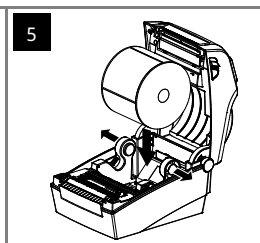
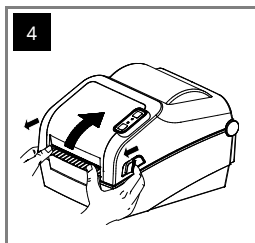
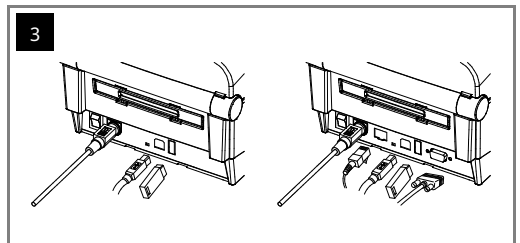
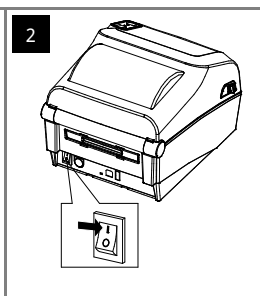
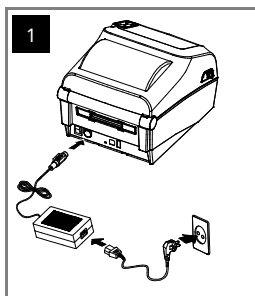
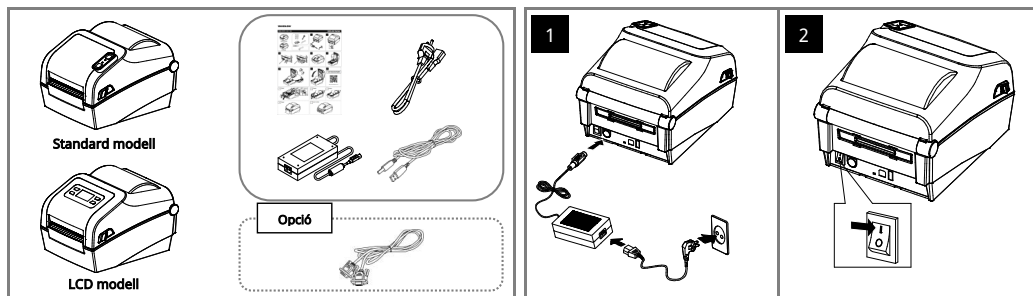



Figyelmeztetés és Vigyázat

A felhasználónak okozott halál, testi sérülés, súlyos pénzügyi veszteség, adatkárosodás stb.

Ne csatlakoztasson több terméket egyetlen vagy hibás konnektorhoz.
Csak az ipari szabványoknak megfelelő konnektort használjon. **A nem megfelelő elektromos csatlakozókat áramütést vagy tüzet okozhat.**



Csak a BIXOLON hiteles termékeit használja. **A vállalat nem nyújt eladás utáni támogatást hamisított (vagy felújított) termékek esetén felmerülő terméksérülés vagy egyéb minőségi problémák miatt.**



Ne hajlítsa meg vagy ne feszítse meg túlzottan a tápkábelét. Biztonságosan nyújtsa be teljesen a tápkábelét a konnektorba, nehogy megfeszüljön. Ügyeljen arra, hogy szorosan tartsa a kábelt, amikor kihúzza a konnektorból. Ne húzza ki a tápkábelét, amíg a termék használatban van. **A nem megfelelő elektromos csatlakozókat áramütést vagy tüzet okozhat.**



A kis tartozékokat vagy egyéb csomagolóanyagokat tartsa távol a kisgyermektől. Vigyázat: Fulladásveszély. **A termék helytelen kezelése olyan sérüléseket okozhat, amelyek sürgős orvosi ellátást igényelhetnek.**



Tartsa távol a tűzoltó mennyiségű folyadékot a tápkábelétől és a konnektortól. Ha anyag került a tápkábelekre, törölje le száraz ruhával. **A nem megfelelő elektromos csatlakozókat áramütést vagy tüzet okozhat.**



Ne hagyja, hogy a terméket nehéz tárgyak károsítsák. **A nem megfelelő elektromos csatlakozókat áramütést vagy tüzet okozhat.**



Ha a termék furcsa hangot bocsát ki, égeszszaga van vagy füstöl, azonnal kapcsolja ki a készüléket, és húzza ki a tápkábelét. Ha a terméket legyek, vagy a külsője megérinti, azonnal kapcsolja ki a készüléket, és húzza ki a tápkábelét. Ne tegye ki a terméket útnak. **Ez a termék károsodását vagy tüzet okozhat.**

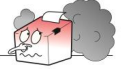

Telepítse a terméket jól szellőző helyen, a kábel távolára a falról. A termék olyan környezetben történő telepítése, amelyben szűzött porok, nedvességnek ki van téve, megzavarhatja a termék működését, vagy a termék túlzott igénybevétele a nyomtatás károsodását okozhatja. A teljes hőmérséklet emelkedése tüzet okozhat. **Ne távolítsa el a terméket előljárólól, fordítson a védőrács felé.**



Rögzített helyre telepítse a terméket, hogy megakadályozza a felborulást. A termék mozgathatókor kapcsolja ki a készüléket, és húzza ki az összes csatlakozótól kábelt, beleértve a tápkábelét is. **Ugyanis ez károsíthatja a terméket.**



Soha ne szereje szét, ne javítsa vagy módosítsa a terméket önállóan, mert a jótállás érvényét veszti. **Ha javításra van szükség, forduljon az eredeti vásárlási helyhez.**



Ne engedje, hogy a termékbe idegen anyag kerüljön. Ne helyezzen nehéz tárgyakat, folyadékokat vagy fémeket a termékre. **Ez a termék károsodását vagy tüzet okozhat.**



Ha a termékkel probléma merül fel, kérjük, forduljon a vásárlási helyhez vagy keresse fel a BIXOLON weboldalának termékjavítási oldalát (www.bixolon.com).



Hungarian