

제품에 대한 자세한 정보는
빅솔론 홈페이지를 참고하세요.

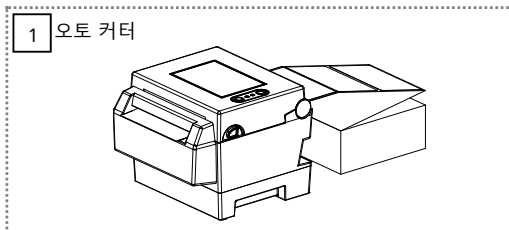

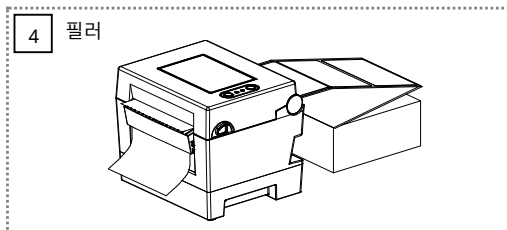
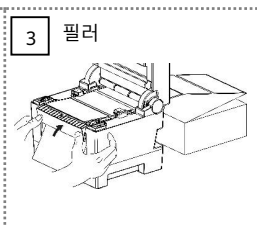
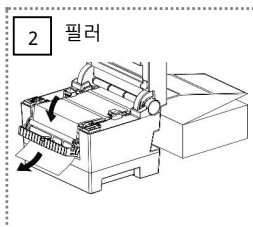
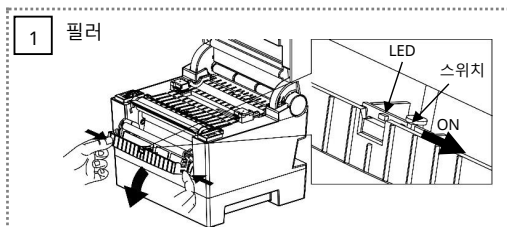

WARNING & CAUTION

Is described as death, physical injuries, serious financial losses, and damage to data etc. that can be caused to the user.



주의 & 경고

사용자의 사망 또는 신체적 손상, 심각한 재산상의 손상, 데이터 등의 정보 손상을 일으킬 가능성이 있는 내용을 설명합니다.

Do not connect multiple products to a single or faulty power outlet. Only use grounded power outlets that meet the industry standard. **Noncompliance may cause electric shock or fire.**



Only use authentic products from BXOLON. The company will not provide post-sale support for damaged or other quality issues that any fake (or refurbished) products may incur.



Do not excessively bend or strain the power cord. Securely push the power cord all the way into the power outlet lest it remain loose. Make sure to hold the cord tight when separating it from the power outlet. Do not remove the power cord while the product is in use. **Noncompliance may cause electric shock or fire.**



Keep small accessories or other packaging materials away from young children. **Mishandling the product may incur injuries which may require seeking urgent medical attention.**



Keep excessive liquids away from the power cord and outlet. If matter is smeared onto the power cords, wipe with a dry cloth. **Noncompliance may cause electric shock or fire.**



Do not allow the product to be damaged by heavy objects. **Noncompliance may cause electric shock or fire.**



If the product emits a strange sound, burning smell, or smoke, turn off the power immediately and unplug the power cord. If the product is dropped or its exterior is damaged, turn off the power immediately and unplug the power cord. Do not subject the product to shock. **This could cause damage to the product or a fire.**



Install the product in a well-ventilated area by keeping it a certain distance from the wall. Installing the product in certain environments which are prone to excessive dust, moisture and temperature fluctuations or putting the product under extreme use may cause damage to the printer. **An increase in internal temperature may start a fire. Be sure to contact the place of purchase if you are unsure of product placement.**



Install the product in a fixed location to prevent it from tipping over. When moving the product, turn off the power and disconnect all connected cables, including the power cord. **As it may damage the product.**



Never independently disassemble, repair, or modify the product as the warranty will become invalid. **When repair is necessary, contact the original place of purchase.**



Do not let any foreign substances enter the product. Do not place heavy objects, liquids, or metals on the product. **This could cause damage to the product or a fire.**



If there is a problem with the product, please contact the original place of purchase or through BXOLON website's product repair page (www.bxolon.com).



하나의 콘센트에 여러 제품을 동시에 연결하지 마세요. 필그라운드 콘센트를 사용하십시오. 콘센트에 부적절한 제품을 사용하면, 반드시 접지된 콘센트에 전원 코드를 연결하십시오. 감전 및 화재의 위험이 있습니다.



반드시 박스 안에서 공급하는 정품만 사용하세요. 유사품(재생품) 사용으로 인한 제품손상에 대한 품질 및 A/S 책임을 지지 않습니다.



전원 코드를 무리하게 구부리거나 잡아당기지 마세요. 전원 코드가 흔들리지 않도록 단단히 꽂아주세요. 전원 콘센트 콘센트에서 분리할 때는 반드시 코드를 잡고 분리하십시오. 제품 사용 중에는 전원 코드를 뽑지 마세요. 감전 및 화재의 위험이 있습니다.



소형 액세서리 또는 포장물은 어린이의 손에 닿지 않는 곳에 보관하세요. 어린이가 삼키지 않도록 주의하세요. 제품을 잘못 다루어 부상을 입힐 수 있습니다. 만약 어린이가 상해를 입었다면 즉시 의사와 상담하세요.



전원 코드를 컷을 때 뿜을 물에 젖은 손으로 만지지 마세요. 전원 코드의 끝 부분 또는 콘센트에 이물질이 묻어 있을 때는 마른 천으로 깨끗이 닦아주세요. 감전 및 화재의 위험이 있습니다.



무거운 물건이 눌러지 않도록 주의하세요. 감전 및 화재의 위험이 있습니다.



제품에서 이상한 소리, 타는 냄새, 연기나 검은 연기나 전원을 끄고 전원 코드를 뽑아주세요. 제품용물(쓰러진)이나 외관이 파손된 경우 즉시 전원을 끄고 전원 코드를 뽑아주세요. 제품예충격을 주지 마세요. 화재의 위험이 있습니다. 제품 손상의 위험이 있습니다.



제품은 벽과 밀착시키거나 벽이 붙지 않는 곳에 설치하세요. 미세 먼지가 밀착되는 곳, 온도나 습도가 높거나 낮거나 습기나 곰팡이 많은 곳, 정전 연속적으로 사용하는 곳이나 벽 등 특수한 장소에 설치된 제품은 주변 환경의 영향을 최소화한 품질 문제가 발생할 수 있습니다. 내부 온도 상승으로 인한 화재의 위험이 발생할 수 있습니다. 반드시 구입처에 문의 후 설치하세요.



제품이 넘어지지 않도록 고정된 상태로 설치하세요. 제품용물일 때는 전원 코드를 끄고 전원 코드를 제품에 연결된 모든 선을 뽑아주세요. 제품용물에서 사용할 때에는 떨어뜨리지 마세요. 제품 손상의 위험이 있습니다.



사용자 임의로 절단 분리, 수리, 개조하지 마세요. 수리가 필요할 때에는 구입처로 연락하세요.



제품 내부에 이물질이 들어가지 않도록 주의하세요. 제품 위에 무거운 물건이나 액체나 금속 물체를 올려놓지 마세요. 화재의 위험이 있습니다. 제품 손상의 위험이 있습니다.



제품의 문제가 생겼을 경우 구입처로 연락하세요. 또한, 박스 온 홈페이지 (www.bxolon.co.kr) 에서 제품 수리 동영상을 제공하고 있습니다.



English

Korean

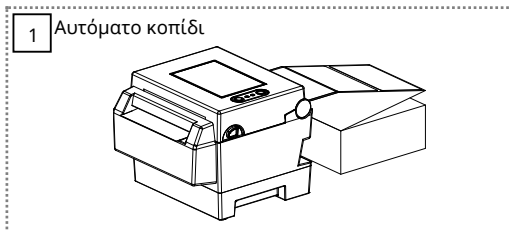
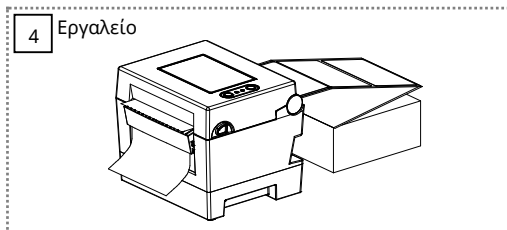
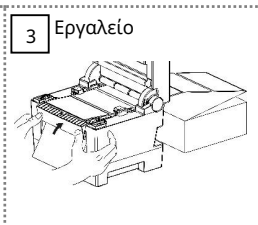
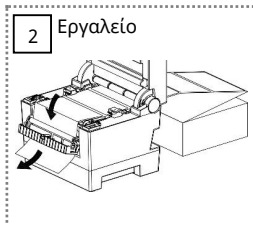
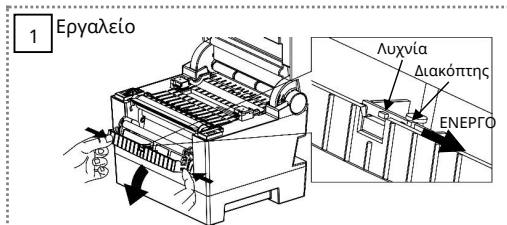
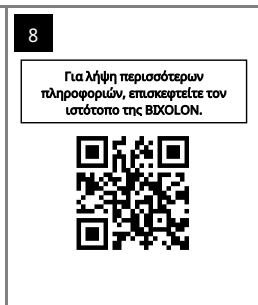
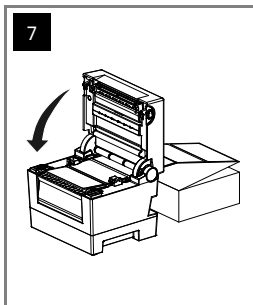
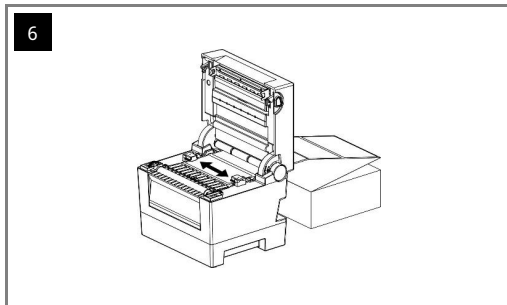
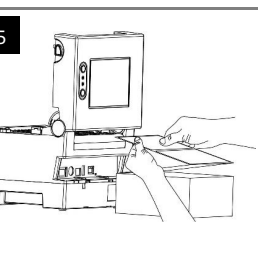
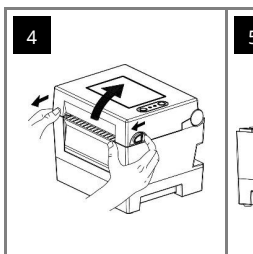
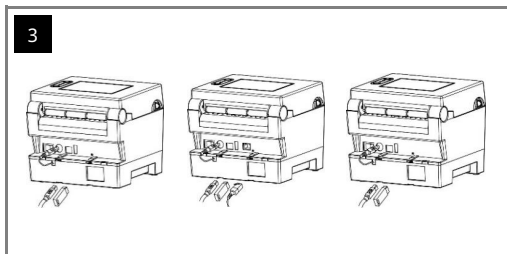
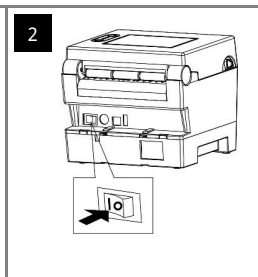
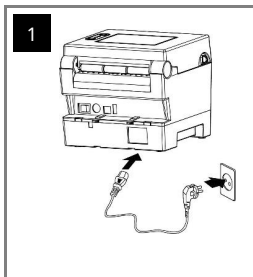
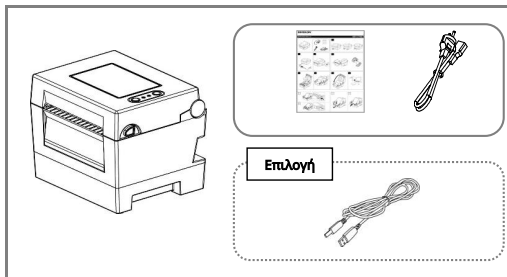

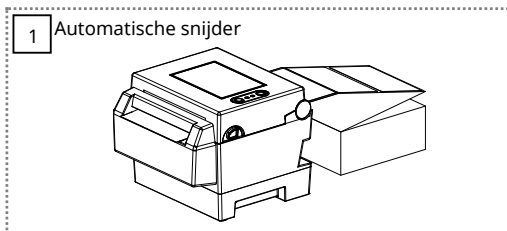
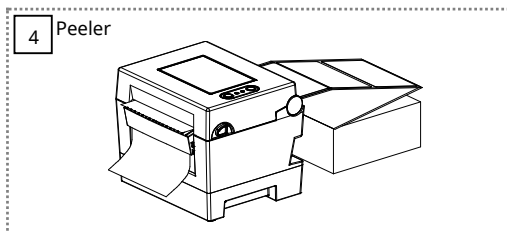
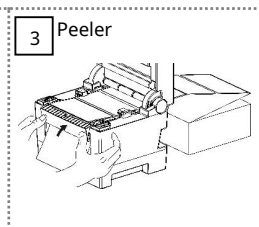
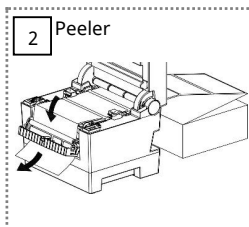
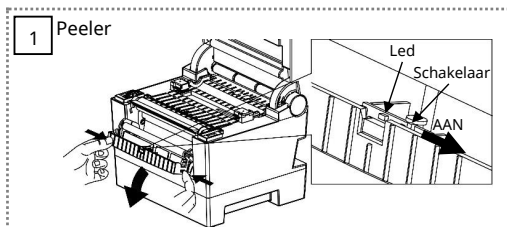
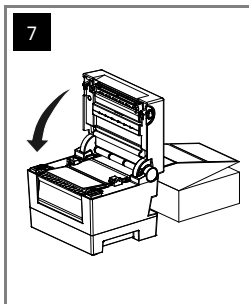
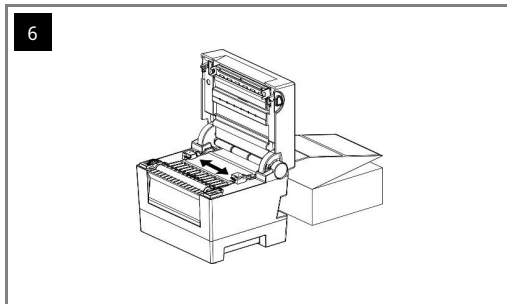
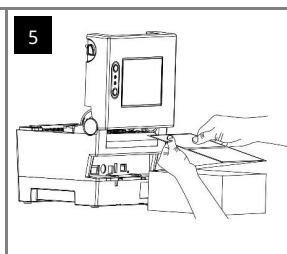
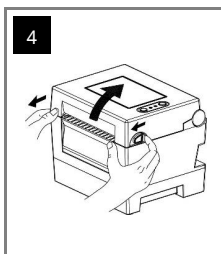
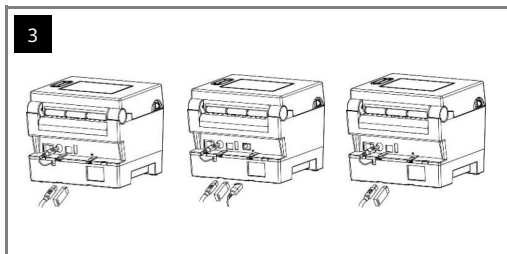
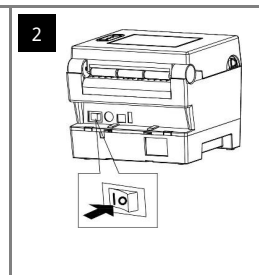
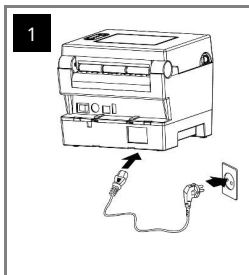
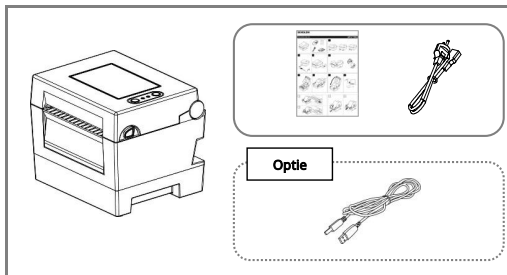



ΠΡΟΕΙΔΟΠΟΙΗΣΗ ΚΑΙ ΠΡΟΣΟΧΗ

Περιγράφεται ως θάνατος, σωματικός τραυματισμός, σοβαρές οικονομικές απώλειες και ζημιές σε δεδομένα κ.λπ. που μπορεί να προκληθούν στον χρήστη.

Μην συνδέετε πολλά προϊόντα σε μία μόνο πρίζα ή σε μία ελαττωματική πρίζα. Χρησιμοποιείτε μόνο γεωμετρικές πρίζες οι οποίες πληρούν τα βιομηχανικά πρότυπα. **Η μη συμμόρφωση μπορεί να προκαλέσει ηλεκτροπληξία ή πυρκαγιά.**



Μην λυγίζετε ή καταστρέφετε υπερβολικά το καλώδιο ρεύματος. Θάψετε με ασφαλή το καλώδιο ρεύματος μέχρις ότου μην πρίζα, καθώς δεν πρέπει να είναι χαλαρό. Βεβαιωθείτε ότι κρατάτε καλά το καλώδιο ότου το αφαιρείτε από την πρίζα. **Μην αφαιρείτε το καλώδιο ρεύματος ενώ το προϊόν βρίσκεται σε χρήση. Η μη συμμόρφωση μπορεί να προκαλέσει ηλεκτροπληξία ή πυρκαγιά.**



Κρατήστε μεγάλες ποσότητες υγρών μακριά από το καλώδιο ρεύματος και την πρίζα. Σε περίπτωση που επιταχυνθεί κάποια ουσία στα καλώδια ρεύματος, σκουπίστε με ένα στεγνό πανί. **Η μη συμμόρφωση μπορεί να προκαλέσει ηλεκτροπληξία ή πυρκαγιά.**



Εάν το προϊόν εκπέμπει παράγοντα φέου, μυρωδιά καμένου ή καπνό, απενεργοποιήστε αμέσως το προϊόν και αποσυνδέστε το καλώδιο ρεύματος. Σε περίπτωση πτώσης του προϊόντος ή βλάβης του εξωτερικού περίβληματος, απενεργοποιήστε αμέσως το προϊόν και αποσυνδέστε το καλώδιο ρεύματος. **Μην υπεβλέπετε το προϊόν σε οποιαδήποτε κατάσταση μπορεί να προκαλέσει ζημιά στο προϊόν ή πυρκαγιά.**



Χρησιμοποιείτε μόνο αυθεντικά προϊόντα της BIXOLON. **Η εταιρεία δεν θα παρέχει υποστήριξη μετά την πώληση για προϊόντα τα οποία έχουν κατασκευαστεί ή άλλα ζητήματα ποιότητας που ενδέχεται να προκύψουν από τούτο (ή ανακατασκευασμένα) προϊόντα.**



Διατρέψτε τα μικρά οθραύρια ή άλλα υλικά συσκευασίας μακριά από τη μικρή πρίζα. Προσοχή: κίνδυνος πνιγμού. **Ο αναθεωρημένος ρυθμιστής του προϊόντος μπορεί να προκαλέσει τραυματισμούς οι οποίοι ενδέχεται να απαιτήσουν επείγουσα ιατρική βοήθεια.**



Μην επιτρέψετε καταστροφή του προϊόντος από βαριά αντικείμενα. **Η μη συμμόρφωση μπορεί να προκαλέσει ηλεκτροπληξία ή πυρκαγιά.**



Εγκαταστήστε το προϊόν σε κατάλληλο χώρο διασύνδεσης το οποίο να μην υποστηρίζει το βάρος. Η ανεπιτυχής του πτώσης σε συγκεκριμένα περιβάλλοντα τα οποία είναι επιρρεπή σε υπερβολική υγρασία, ατμοσφαιρικούς θορυβιστικούς ή τοξικούς αερίους, μπορεί να προκαλέσει βλάβη στον εκτυπωτή. Μια αόριστη ή μη σωστή λειτουργία μπορεί να προκαλέσει πυρκαγιά. **Μην προσέχετε να αποσυναρμολογήσετε με το κατάστημα από το οποίο αγοράσατε το προϊόν εάν ένα είναι ελαττωματικό για την τοποθέτησή του.**



Μην αποσυναρμολογείτε, επισκευάζετε ή τροποποιείτε από μόνοι σας το προϊόν, καθώς η εγγύηση θα καταστεί άκυρη. **Στον απαιτούμενο επισκευή, επισκευάστε με το κατάστημα στο οποίο πραγματοποιήσατε την αγορά.**



Εάν υπάρχει πρόβλημα με το προϊόν, αποσυνδέστε με το κατάστημα από το οποίο αγοράσατε το προϊόν ή με τη σελίδα επισκευής προϊόντων του ιστότοπου BIXOLON (www.bixolon.com).



WAARSCHUWINGEN

Wort beschreven als overlijden, lichamelijk letsel, ernstige financiële verliezen en schade aan gegevens enz. die aan de gebruiker kunnen worden toegebracht.

Sluit niet meerdere producten aan op één stopcontact of op een defect stopcontact. Gebruik alleen geaarde stopcontacten die voldoen aan de industriestandaard. **Als u zich niet aan de voorschriften houdt, kan dit leiden tot elektrische schokken of brand.**



Buig of belast het netsnoer niet te veel. Zorg dat de stekker correct in het stopcontact zit. Trek altijd aan de stekker en niet aan het snoer: als u de stekker uit het stopcontact wilt halen. Vermijd het netsnoer niet terwijl het product in gebruik is. **Als u zich niet aan de voorschriften houdt, kan dit leiden tot elektrische schokken of brand.**



Houd vloeistoffen uit de buurt van het netsnoer en het stopcontact. Reinig het netsnoer met een droge doek. **Als u zich niet aan de voorschriften houdt, kan dit leiden tot elektrische schokken of brand.**

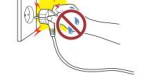

Als het product een veemd geluid, een brandgeur of rook afgeeft, schakel dan onmiddellijk de stroom uit en trek de stekker uit het stopcontact. Als het product uit de buitenkant beschadigd is, schakel dan onmiddellijk de stroom uit en trek de stekker uit het stopcontact. **Stel het product niet bloot aan schokken. Dit kan schade aan het product of brand veroorzaken.**



Installeer het product op een vaste locatie om te voorkomen dat het omvalt. Schakel tijdens het verplaatsen van het product de stroom uit en koppel alle aan gesloten kabels los, inclusief het netsnoer. **Kabels kunnen tijdens het transport of de verplaatsing beschadigd raken.**



Zorg ervoor dat er geen vreemde stoffen in het product terechtkomen. Plaats geen zware voorwerpen, vloeistoffen of metalen op het product. **Dit kan schade aan het product of brand veroorzaken.**



Gebruik alleen authentieke producten van BIXOLON. **Het bedrijf biedt geen ondersteuning na de verkoop voor beschadigde of andere kwaliteitsproblemen die kunnen optreden bij namaakproducten (of gefabriceerde) producten.**



Houd kleine accessoires of ander verpakkingsmateriaal buiten het bereik van jonge kinderen. Let op verstikkingsgevaar. **Verkeerd gebruik van het product kan leiden tot verwondingen waarvoor dringend medische hulp nodig is.**



Zorg ervoor dat het product niet wordt beschadigd door zware voorwerpen. **Als u zich niet aan de voorschriften houdt, kan dit leiden tot elektrische schokken of brand.**



Installeer het product in een goed geventileerde ruimte. Houd altijd enige afstand tot de muur. Als u het product installeert in bepaalde omgevingen die gevoelig zijn voor overmatig stof, vocht en temperatuurschommelingen of wanneer het product extreem wordt gebruikt, kan de printer beschadigd raken. Een verhoging van de binnentemperatuur kan brand veroorzaken. **Neem contact op met de plaats van aankoop als u niet zeker bent van de plaatsing van het product.**



Demonteer, repareer of wijzig het product nooit zelfstandig, aangezien anders de garantie vervalt. **Als reparatie nodig is, neem dan contact op met de oorspronkelijke plaats van aankoop.**



Als er een probleem is met het product, neem dan contact op met de oorspronkelijke plaats van aankoop of via de productreparatiepagina van de BIXOLON-website (www.bixolon.com).



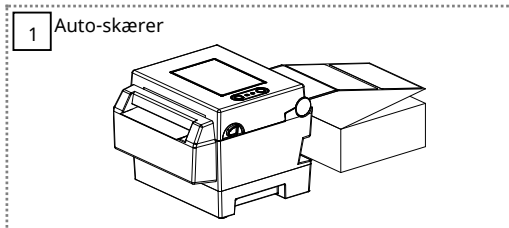
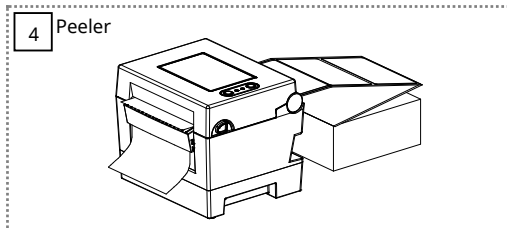
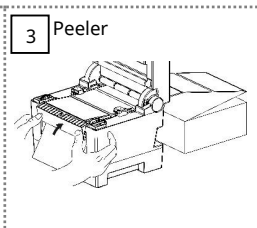
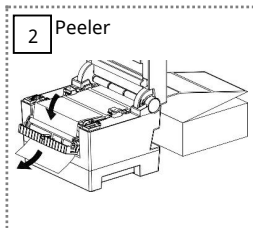
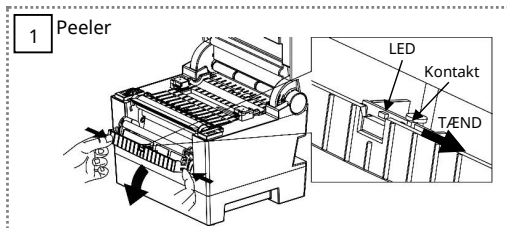
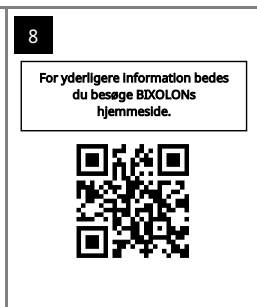
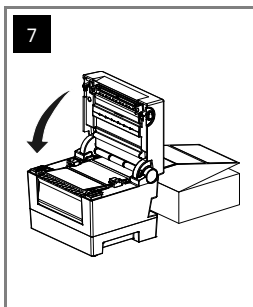
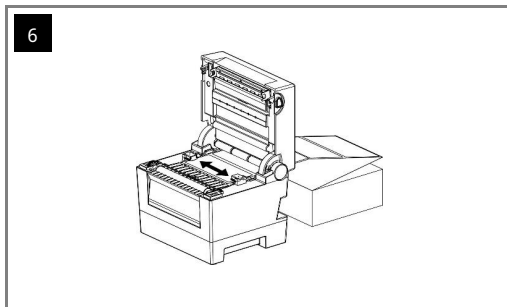
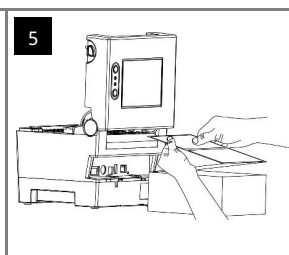
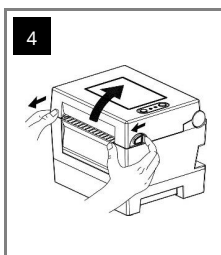
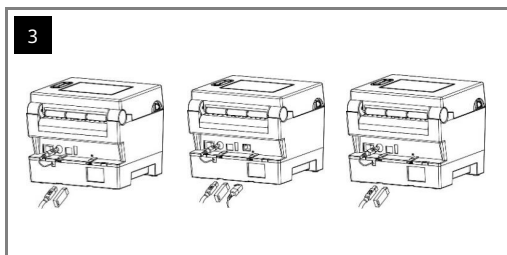
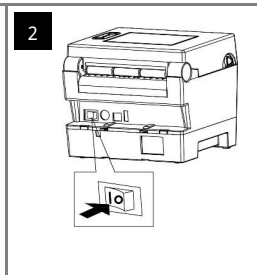
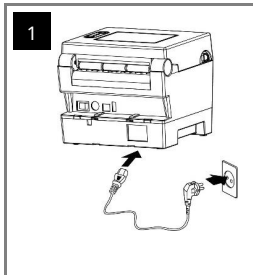
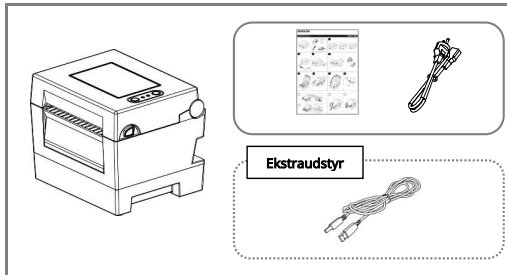

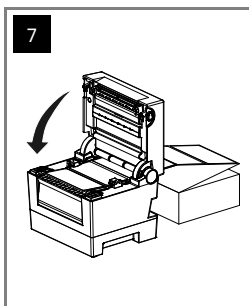
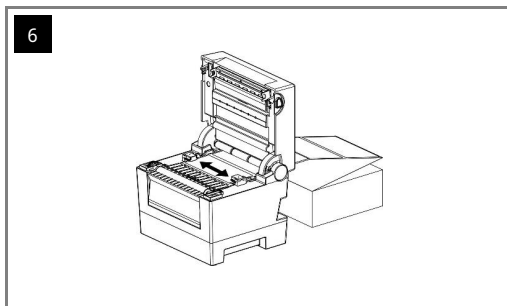
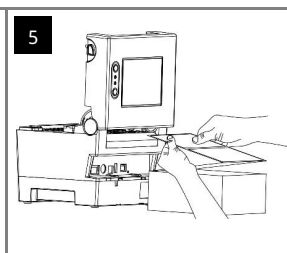
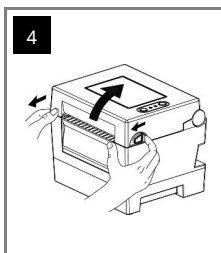
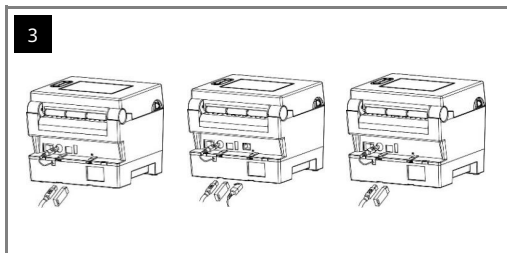
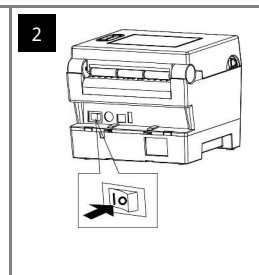
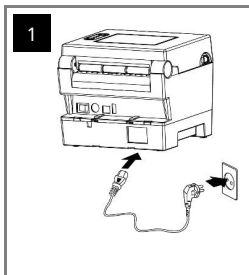
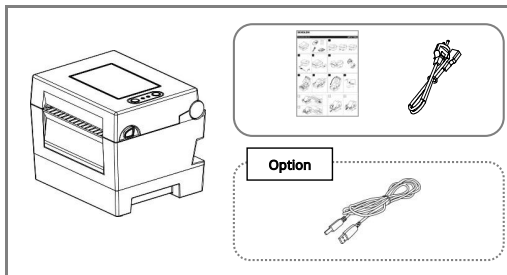

Um weitere Informationen herunterzuladen, besuchen Sie bitte die Website von BIXOLON.

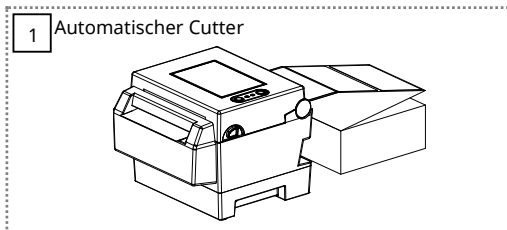
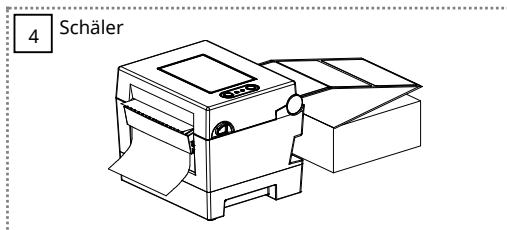
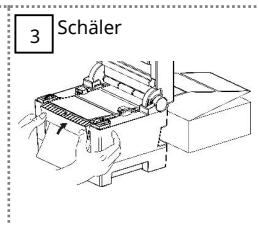
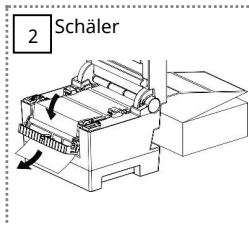
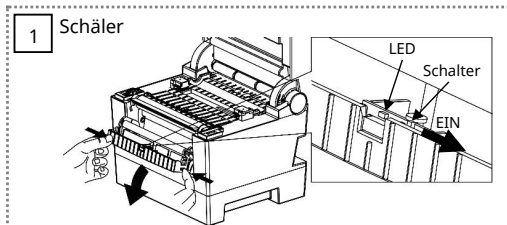

ADVARSEL OG FORSIGTIGHED

Beskrives som død, fysiske skader, alvorlige økonomiske tab og beskadigelse af data m.m., der kan påføres brugeren.



Tilslut ikke flere produkter til en enkelt eller defekt stikkontakt. Brug kun stikkontakter med jordforbindelse, der opfylder industristandarden. **Manglende overholdelse kan forårsage elektrisk stød eller brand.**



Brug kun autentiske produkter fra BIXOLON. **Virksomheden yder ikke support efter salg ved skade eller andre kvalitetsproblemer, som eventuelle falske (eller renoverede) produkter kan påføre sig.**



Undgå at bære eller belaste strømkablet for meget. Skub strømkablet helt ind i stikkontakten, så det ikke sidder løst. Sørg for at holde godt fast i kablet, når du tager det ud af stikkontakten. Fjern ikke strømkablet, mens produktet er i brug. **Manglende overholdelse kan forårsage elektrisk stød eller brand/muskyld.**



Hold småt tilbehør eller andet emballagemateriale væk fra små børn. Pas på fare for kvæsting. **Føret håndtering af produktet kan medføre skader, som kan kræve akut lægehjælp.**



Hold større mængder væske væk fra strømkablet og stikkontakten. Hvis der er smurt stof på strømkablet, skal du tørre dem af med en tør klud. **Manglende overholdelse kan forårsage elektrisk stød eller brand.**



Lad ikke produktet blive beskadiget af tunge genstande. **Manglende overholdelse kan forårsage elektrisk stød eller brand.**



Hvis produktet udsender en mærkelig lyd, en brændende lugt eller røg, skal du straks slukke for strømmen og tage strømkablet ud. Hvis produktet tabes eller beskadiges uventet, skal du straks slukke for strømmen og trække strømkablet ud. Udskat ikke produktet for stat. **Dette kan medføre skader på produktet eller brand.**



Installer produktet i et godt ventileret område ved at holde det i en vis afstand fra væggen. Hvis produktet installeres i vove miljøer, der er udsat for meget støv, fugt og temperaturudsving, eller hvis produktet udsættes for ekstrem brug kan produktet blive beskadiget. En stigning i den indre temperatur kan starte en brand. **Sørg for at kontakten håndteres for, hvis du er i tvivl om produktets placering.**



Installer produktet på en fast sted for at forhindre, at det vælter. Når du flytter produktet, skal du slukke for strømmen og frakoble alle tilsluttede kabler, inklusive strømkablet. **Da det kan beskadige produktet.**



Du må aldrig selv adskille, reparere eller ændre produktet, da garantien da vil blive ugyldig. **Hvis reparation er nødvendig, skal du kontakte det oprindelige købssted.**



Lad ikke fremmede substanser komme ind i produktet. Anbring ikke tunge genstande, væsker eller metaller på produktet. **Dette kan medføre skader på produktet eller brand.**



Hvis der er et problem med produktet, bedes du kontakte det oprindelige købssted eller besøge BIXOLON's hjemmeside på produktreparations siden (www.bixolon.com).



WARNUNG & VORSICHTSMAßNAHMEN

Durch Nichtbeachtung der nachstehenden Hinweise kann es zu Personenschäden, Vermögensschäden, schweren Personenverletzungen oder tödlichen Unfällen kommen.



Schließen Sie nicht mehrere Produkte an eine einzige fehlerhafte Steckdose an. Verwenden Sie nur geerdete Steckdosen, die den Industriestandard entsprechen. **Eine Nichtbeachtung kann zu einem elektrischen Schlag oder zu einem Brand führen.**



Verwenden Sie nur authentische Produkte von BIXOLON. **Das Unternehmen bietet keinen Support für beschädigte oder sonstige Qualitätsprobleme, die bei gefälschten (oder generalüberholten) Produkten nach dem Kauf auftreten können.**



Biegen oder belasten Sie das Netzkabel nicht übermäßig. Stecken Sie das Netzkabel fest in die Steckdose, damit es nicht lose ist. Achten Sie darauf, das Kabel festzuhalten, wenn Sie es von der Steckdose nehmen. Entfernen Sie das Netzkabel nicht, während das Produkt verwendet wird. **Eine Nichtbeachtung kann zu einem elektrischen Schlag oder zu einem Brand führen.**



Halten Sie kleine Zubehöreile oder andere Verpackungsmaterialien von kleinen Kindern fern. Achtung: Ersticken/Erstickungsgefahr. **Eine unangenehme Handhabung des Produktes kann zu Verletzungen führen, die möglicherweise dringende medizinische Maßnahmen erfordern.**



Halten Sie übermäßige Flüssigkeiten vom Netzkabel und der Steckdose fern. Wenn die Netzkabel verschmiert sind, wischen Sie sie mit einem trockenen Tuch ab. **Eine Nichtbeachtung kann zu einem elektrischen Schlag oder zu einem Brand führen.**



Lassen Sie das Produkt nicht durch schwere Gegenstände beschädigen. **Eine Nichtbeachtung kann zu einem elektrischen Schlag oder zu einem Brand führen.**



Wenn das Produkt ein seltsames Geräusch, Brandgeruch oder Rauch abgibt, schalten Sie es sofort aus und ziehen Sie das Netzkabel ab. Wenn das Produkt fallen gelassen oder äußerlich beschädigt wird, schalten Sie es sofort aus und ziehen Sie das Netzkabel ab. Setzen Sie das Produkt keinem Stoß aus. **Dies könnte zu Schäden am Gerät oder zu einem Brand führen.**



Installieren Sie das Produkt in einem gut belüfteten Bereich und halten Sie einen gewissen Abstand zur Wand. Wenn Sie das Produkt bestimmten Umgebungsbedingungen, wie übermäßigem Staub, Feuchtigkeit, oder Temperaturerwartungen aussetzen, oder es extrem baugerechtes kann es beschädigt werden. **Die Durchführung der internen Temperatur kann einen Brand auslösen. Wenden Sie bitte an Ihre Händler, wenn Sie sich bezüglich der Produktplatzierung nicht sicher sind.**



Installieren Sie das Produkt an einem festen Ort, um ein Umkippen zu verhindern. Wenn Sie das Produkt bewegen wollen, schalten Sie es aus und trennen Sie alle angeschlossenen Kabel, einschließlich des Netzkabels. **Andersfalls kann dies das Produkt beschädigen kann.**



Zerlegen, reparieren oder modifizieren Sie das Produkt niemals selbstständig, da andernfalls die Garantie erlischt. **Wenn eine Reparatur erforderlich ist, wenden Sie sich an die ursprüngliche Verkaufsstelle.**



Lassen Sie keine Fremdstoffe in das Produkt eindringen. Stellen Sie keine schweren Gegenstände, Flüssigkeiten oder Metalle auf das Produkt. **Dies könnte zu Schäden am Produkt oder einem Brand führen.**



Wenn es ein Problem mit dem Produkt gibt, wenden Sie sich bitte an die ursprüngliche Verkaufsstelle oder über die Produktreparationsseite der BIXOLON-Website (www.bixolon.com).



Danish

German

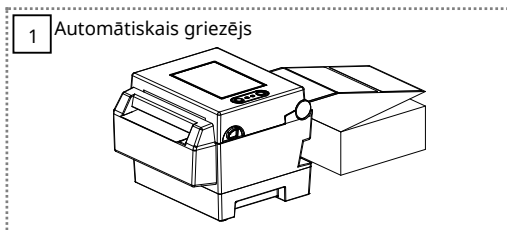
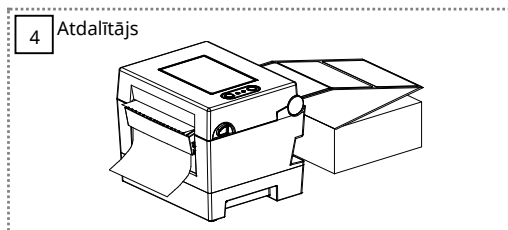
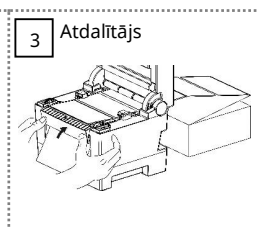
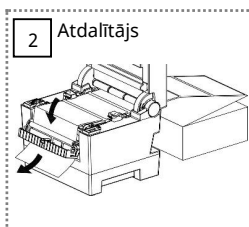
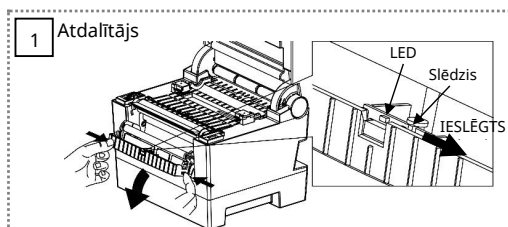
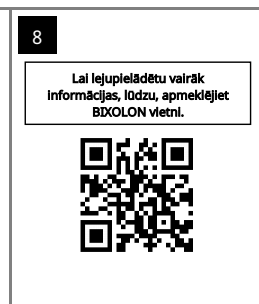
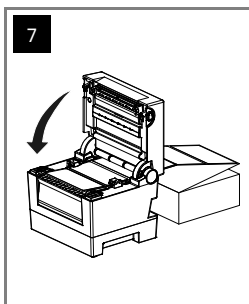
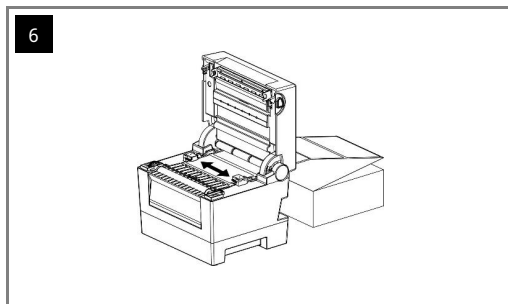
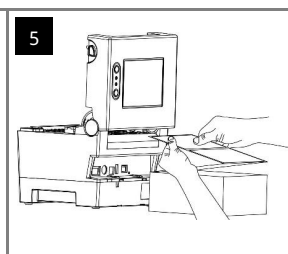
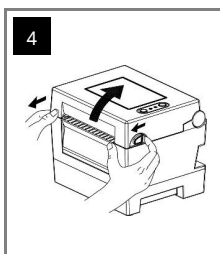
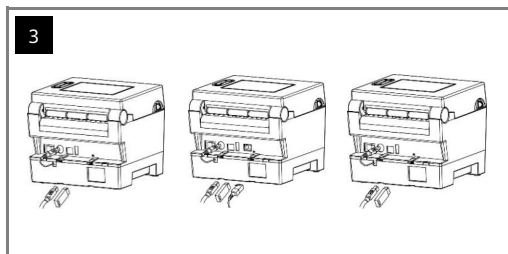
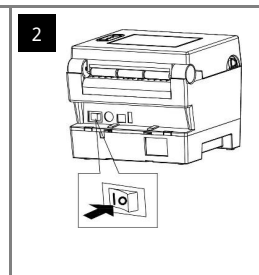
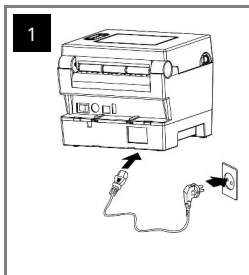
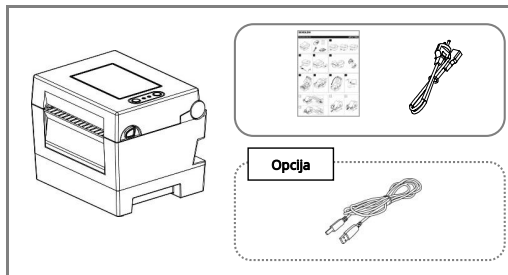

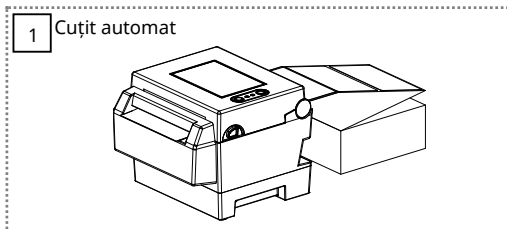
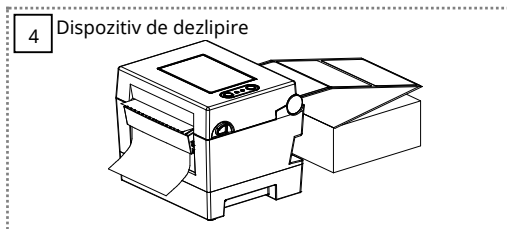
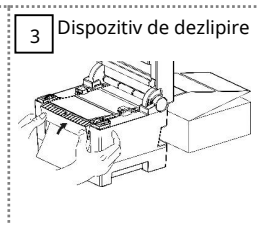
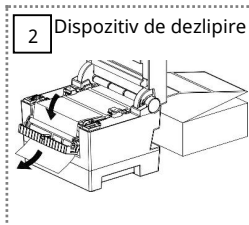
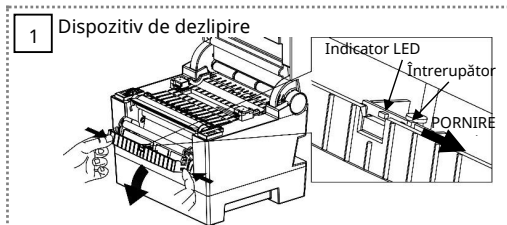
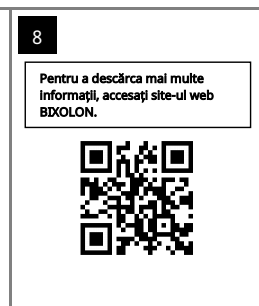
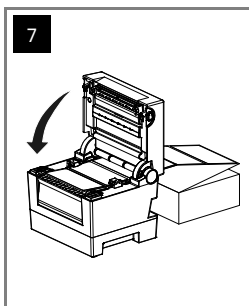
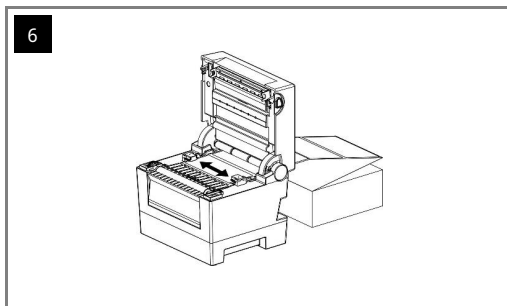
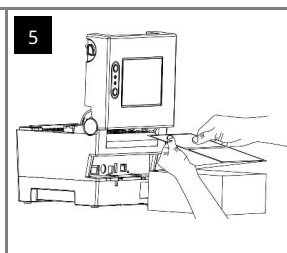
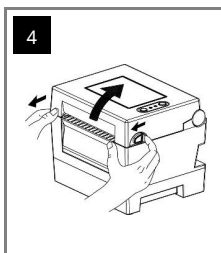
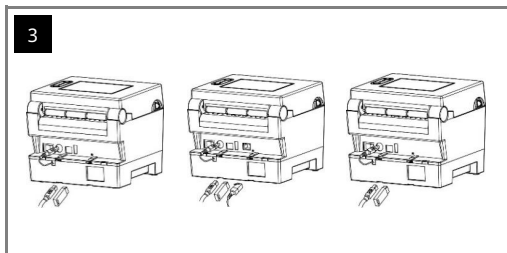
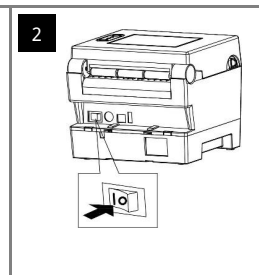
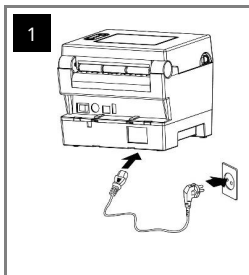
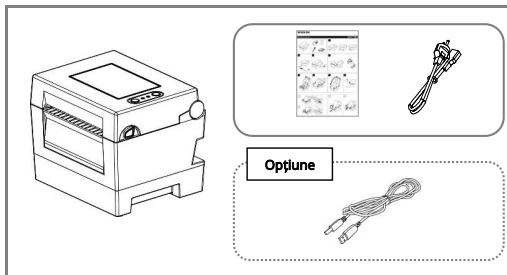



BRĪDINĀJUMS / IEVĒROT PIESARDZĪBU

Nozīmē nāvi, traumas, nopietnus finansālus zaudējumus, datu bojājumus u.c., kas var tikt nodarīti lietotājam.



AVERTISMENTE ȘI ATENȚIUNĂRI

Indică evenimente precum deces, vătămări fizice, pierderi financiare grave și deteriorarea a datelor etc. pe care le poate suferi utilizatorul.

Nepieslēdziet vairākus izstrādājumu vienā vai bojātai strāvas kontaktligzdai. Izmantojiet tikai tādas izemētas kontaktligzdas, kas atbilst nozaras standartiem. **Neievērošana var izraisīt strāvas triecienu vai ugunsgrēku.**

Izmantojiet tikai autentiskus BIXOLON izstrādājumus. **Uzņēmums neņemsis pēcapārdošanas atbilstu bojājumu vai citu kvalitātes problēmu gadījumā, kas var rasties saistībā ar viltotiem (vai aizaugdromiem) izstrādājumiem.**

Pārņirgējiet netoietot un nenospietiet strāvas vadu. Droši izslēdziet strāvas vadu, līdz galam strāvas kontaktligzdā, lai tas nepaliktu vaļīgs. Parīecināties, ka atvienojot vadu no strāvas kontaktligzdas, **turēt to cieši. Neievērošana var izraisīt strāvas triecienus vai ugunsgrēkus.**

Nelietojat piederumus vai citus iepakojuma materiālus glabāties tā, lai tie nebloķē pieejas mašīnas iekšmē. Uzmanieties: atzīšanās risks. **Nepareiza apkalpošana ar izstrādājumu var radīt traumas, kuru dēļ var būt nepieciešama stādāma medicīniskā palīdzība.**

Uzglabājiet lietus šķidrumu daudzumus tālu no strāvas vada un kontaktligzdas. Ja uz strāvas vadiem ir uzsmērēta kāda viela, noslaukiet to ar sausu drānu. **Neievērošana var izraisīt strāvas triecienus vai ugunsgrēkus.**

Nepieļaujiet, ka izstrādājumu sabojā smagi priekšmeti. **Neievērošana var izraisīt strāvas triecienus vai ugunsgrēkus.**

Ja izstrādājums radījis dīvānu skaņu, deguma smaku vai citus nelabvēlīgus izskaidējumus, pārtrauciet strāvas vada, ja izstrādājums ir noietais vai tā ātrpuse ir bojāta, nekavējoties izslēdziet strāvas padevi un atvienojiet strāvas vadu. **Nepieļaujiet izstrādājumu tīrīšanu. Tas var izraisīt bojājumus, zaudējumus vai ugunsgrēkus.**

Uzstādiet izstrādājumu tālu vēdināmā vietā, ievērojot noteiktu attālumu no sienas. Izstrādājuma uzstādīšana noietais vidē, kurās ir tendence uz pārmerģu paaugstinātu mitruma daudzumu un temperatūras svārstībām, vai izstrādājuma smērēšana elektroniskās apkalpošanas var izraisīt gremošanas bojājumus, iekšējās temperatūras paaugstināšanu vai izraisīt ugunsgrēkus. **Ja rašanās palīdzības par izstrādājuma noietājumu, sazinieties ar pārdevēju vietu.**

Uzstādiet izstrādājumu stabilā vietā, lai novērstu tā apgāšanās. Pārīeciniet izstrādājumu, izslēdziet strāvas padevi un atvienojiet visus pievienotos vadus, tostarp strāvas vadu. **Cikādi var sabojāt izstrādājumu.**

Nekad patstāvīgi neizjauciet, neremontējiet vai neievietiet izmaiņas izstrādājuma, jo tad garantija zaudēs spēku. **Ja nepieciešams remonts, sazinieties ar sākotnējo iegādēšanas vietu.**

Nepieļaujiet, ka izstrādājuma nonāk jebkādas svešķermeņi. Nenovietojiet uz izstrādājuma smagus priekšmetus, šķidrumus vai metālus. **Tas var izraisīt izstrādājuma bojājumus vai ugunsgrēkus.**

Ja rodas problēmas ar izstrādājumu, lūdzu, sazināties ar sākotnējo iegādēšanas vietu vai izmantojiet BIXOLON tīmekļa vietnes izstrādājumu remonta lapu (www.bixolon.com).

Nu conectajai mai multe produse la o singură priză sau la o priză defectă. Utilizați numai prize cu împământare, care îndeplinesc standardele din domeniu. **Nerespectarea acestui prevederi poate provoca electrocutare sau incendiu.**

Folosiți numai produse autentice de la BIXOLON. **Compania nu va oferi asistență post-vânzare pe probleme legate de deteriorări sau alte probleme de calitate, care pot apărea ca urmare a unor produse false (sau recondiționate).**

Nu îndoiți și nu întindeți excesiv cablul de alimentare. Împingeți bine cablul de alimentare până la capăt în priză de alimentare astfel încât să nu asirne. Asigurați-vă că țineți bine de cablu atunci când îl trageți din priză. Nu scoateți cablul de alimentare în timp ce produsul este în uz. **Nerespectarea acestui prevederi poate provoca electrocutare sau incendiu.**

Țineți accesoriile mici sau alte materiale de ambalare departe de ochii mici. **Atenție: percută de sulfocare. Manipularea greșită a produsului poate provoca răni care pot necesita solikarea de asistență medicală urgentă.**

Țineți lichidele departe de cablul de alimentare și de priză. Dacă lichidul ajunge pe cablurile de alimentare, ștergeți cu o lavetă uscată. **Nerespectarea acestui prevederi poate provoca electrocutare sau incendiu.**

Nu permiteți ca produsul să fie deteriorat de obiecte grele. **Nerespectarea acestui prevederi poate provoca electrocutare sau incendiu.**

Dacă produsul emite un sunet neobișnuit, degajă miros de ars sau fum, opriți imediat alimentarea și deconectați cablul de alimentare. Dacă produsul a căzut sau exteriorul său este deteriorat, opriți imediat alimentarea și deconectați cablul de alimentare. Nu supuneți produsul la șocuri. **Acest lucru ar putea cauza deteriorarea produsului sau un incendiu.**

Instalați produsul într-o zonă bine aerisită, ținând o anumită distanță față de perete. Instalarea produsului în anumite medii care sunt predispuse la puf excesiv, umiditate și fluctuații de temperatură sau suficientă excesivă a produsului poate cauza deteriorarea imprimantei. O creștere a temperaturii interne poate denunța un incendiu. **Așigurați-vă că lăsați legătura cu locul de unde a achiziționat produsul, dacă aveți returnuri în primă la locul în care trebuie instalat.**

Instalați produsul într-un loc fix, pentru a preveni răsturnarea acestuia. Când mutați produsul, opriți alimentarea și deconectați toate cablurile conectate, inclusiv cablul de alimentare. **În caz contrar, produsul poate fi deteriorat.**

Nu dezamblati, nu reparați și nu modificați niciodată produsul pe cont propriu, deoarece acest lucru duce la anularea garanției. **Când este necesară repararea, contactați locul de unde ați achiziționat inițial produsul.**

Nu lăsați nicio substanță străină să pătrundă în produs. Nu așezați obiecte grele, lichide sau metale pe produs. **Acest lucru ar putea cauza deteriorarea produsului sau un incendiu.**

Dacă există o problemă cu produsul, contactați locul de unde ați achiziționat inițial produsul sau accesați pagina de reparații a produsului, de pe site-ul web BIXOLON (www.bixolon.com).

Latvian

Romanian

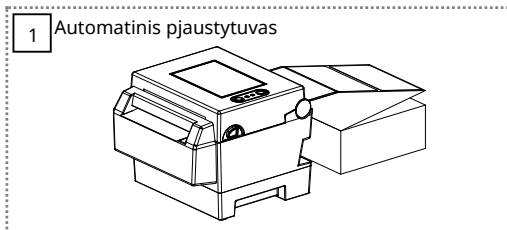
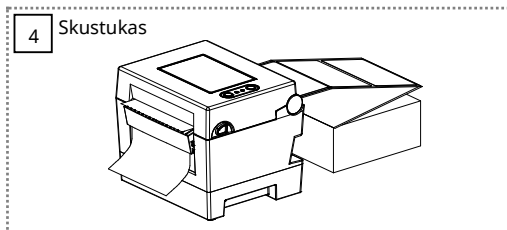
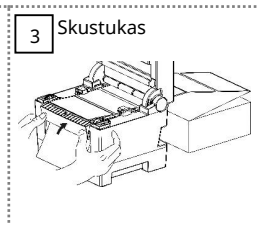
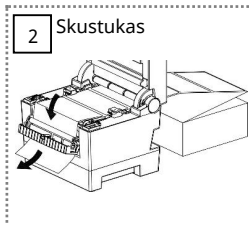
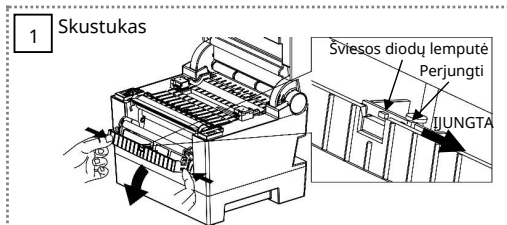
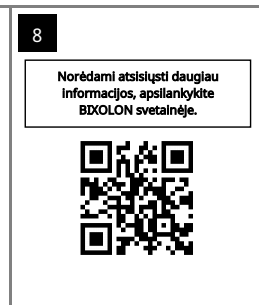
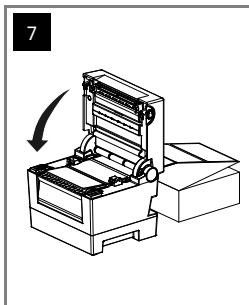
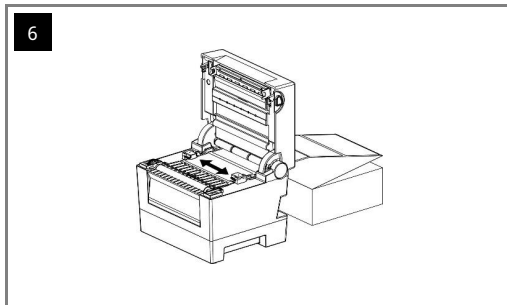
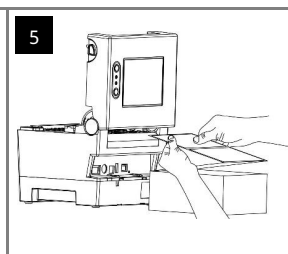
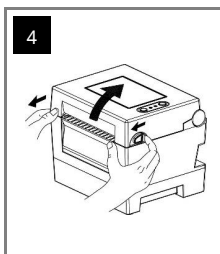
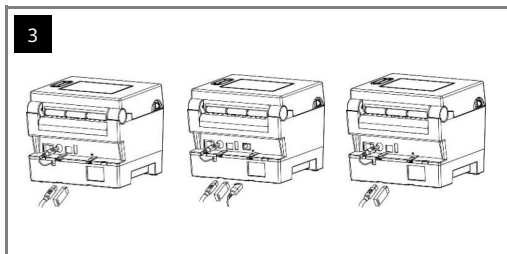
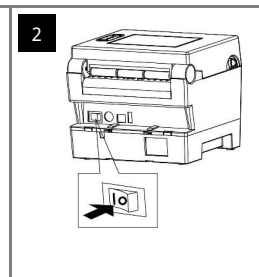
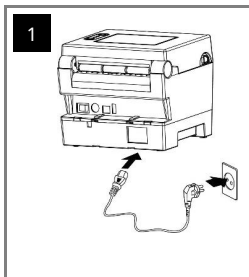
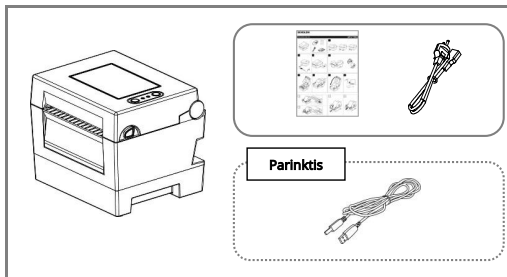

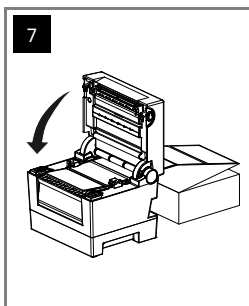
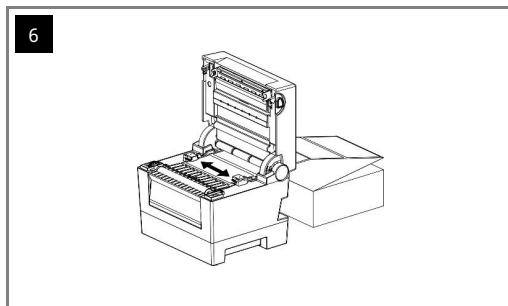
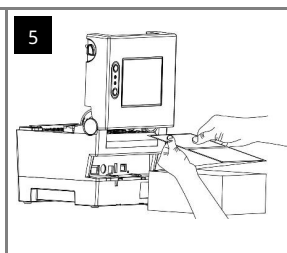
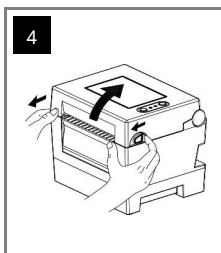
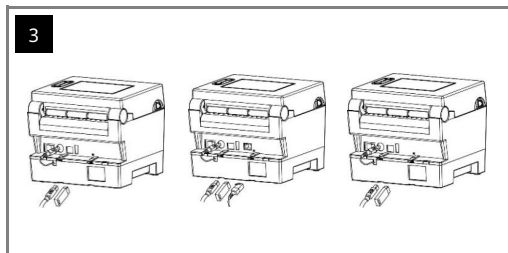
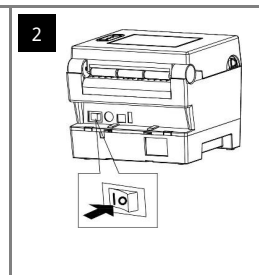
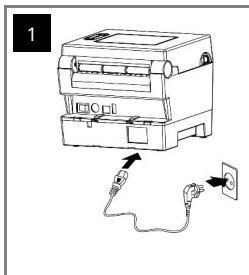
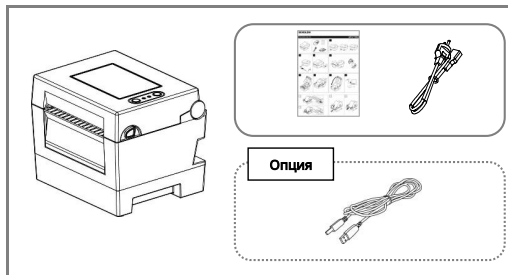

За да изтеглите повече информация, посетете уебсайта на BIXOLON.

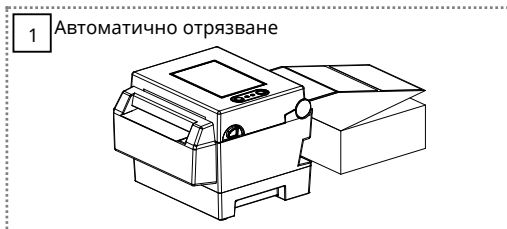
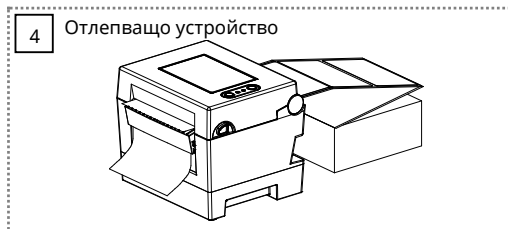
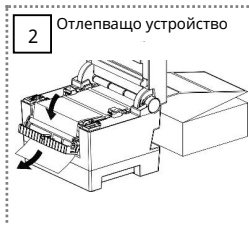
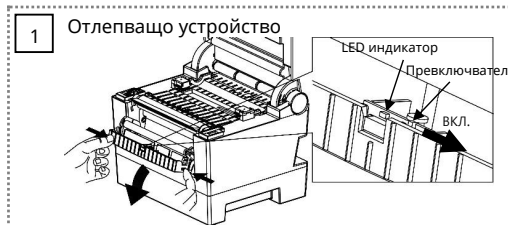



ĮSPĖJIMAI IR PERSPĖJIMAI

Apibūdinama kaip naudotojo mirtis, fiziniai sužalojimai, dideli finansiniai nuostoliai, duomenų sugadinimas ir kt.

Prie vieno maitinimo lizdo neprjunkite kelių gaminių, arba nejunkite jų, jei lizdas yra sugedęs. Naudokite tik įregistruotus elektros lizdus, atitinkančius pramonės standartą. **Neatitiktumas gali sukelti elektros smūgį arba gaisrą.**



Naudokite tik autentiškus BIXOLON gaminius. **Įmonė neteikia pagalbos po pardavimo dėl sugadintų ar kitų kokybės problemų, su kuriomis gali susidurti padirbtai (arba atbraukti) gaminiai.**



Pernelyg nelaukite ir neįtemptkite maitinimo laidų. Saugiai įstumkite maitinimo laidą į galo maitinimo lizdą, kad jis neatsilaisvintų. Atgundama laidą nuo maitinimo lizdo būtina tvirtai laikyti jį už laido. Nesūrinkite maitinimo laidų, kol gaminys neužsikaršęs. **Neatitiktumas gali sukelti elektros smūgį arba gaisrą.**



Mažus priedus ar kitas pakavimo medžiagas laikykite atokiau nuo mažų vaikų. Saugokitės pavojus užspringti. **Netinkamai elgdamiesi su gaminiu galite susižeisti, todėl gali tapti stubilai kreipėsi gydytojų.**



Saugokite, kad prie maitinimo laido ir lizdo nepatektų skysčių. Jei ant maitinimo laidų pateko medžiagos, nuvalykite sausu skudurėliu. **Neatitiktumas gali sukelti elektros smūgį arba gaisrą.**



Neleiskite, kad gaminį pažeistų sunkūs daktai. **Neatitiktumas gali sukelti elektros smūgį arba gaisrą.**



Jei gaminys skęsta keista garso, dūgelių, krepšio arba dūmus, nedelsdami išjunkite maitinimą ir atjunkite maitinimo laidą. Jei gaminys nukrito arba buvo pažeistas į šoną, nedelsdami išjunkite maitinimą ir atjunkite maitinimo laidą. Niekada neįjunkite gaminio, jei jis yra įkaitęs. **Dėl to gali būti pažeistas gaminys arba kiti gaisras.**



Gaminį montavusite gerai vidurinėje vietoje, laikydamiesi jame tūlo atstumo nuo sienos. Įjunkus gaminį tam šiltesnė vietoje, kuriose yra per didelės dūlės, dregmės ir temperatūros svyravimų kėbels, arba naujagimis, gaminį elektromagnetinis spinduliuavimas gali būti sugadintas. Vidinių sąrašų, padedantys temperatūra gali sukelti gaisrą. **Toliau kreipkitės į pirmo vieta, jei nesate širvi dėl produkto pažeidimo.**

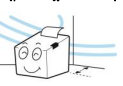

Gaminį sumontuokite fiksatoriaus vietoje, kad jis nevirvintų. Judindami gaminį, išjunkite maitinimą ir atjunkite visus prijungtus kabelius, įskaitant maitinimo laidą. **Kiti atveju, tai gali sugadinti gaminį.**



Niekada savarankiškai nedyrinkite, neremontuokite ir nemodifikuokite gaminio, nes garantija nustos galioti. **Jei reikia atlikti remontą, kreipkitės į pirmine pirkimo vietą.**



Neleiskite jokioms pašalinėms medžiagoms patekti ant produkto. Ant gaminio nedėkite sunkių daiktų, skysčių, šilumos, ar metalų. **Dėl to gali būti pažeistas gaminys arba kiti gaisras.**



Jei su gaminiu išdilo problemų, kreipkitės į pirmine pirkimo vietą arba į BIXOLON svetainės gaminio remonto puslapį (www.bixolon.com)



ПРЕДУПРЕЖДЕНИЕ И ВНИМАНИЕ

Обозначает риск от смерти, физические повреждения, серьезные финансовые убытки, повреждение на данные и т.п., которые могут быть причинены на потребителя.

Не связывайте несколько продукта к мк един-единствен или поврежден электрические контакты. Используйте само заземление электрических контакты, които отговарят на стандартите. **Неисправеното на това предупреждение може да доведе до токов удар или пожар.**



Използвайте само оригинални продукти на BIXOLON. **Компанията не осигурява гаранционен ремонт на повредени или други децети, които могат да бъдат повредени при употреба на фалшиви (или възстановени) продукти.**



Не оголявайте и не отчайте прекомерно захранващия кабел. Натиснете захранващия кабел до края в контакта, за да не остане разкоблен. Уверете се, че кабелът е правилно вставен в контакта. Не използвайте захранващия кабел, докато продуктът работи. **Неисправеното на това предупреждение може да доведе до токов удар или пожар.**



Дръжте малките аксесоари или други опасовелни материали далеч от малки деца. **Внимание: опасност от задушване. Неправилното боравене с продуктите може да доведе до нараняване, които да наложат спешна медицинска помощ.**



Съхранявайте течностите далеч от захранващия кабел и контакта. Ако върху захранващия кабел и поплазна вода, избършете я със суха кърпа. **Неисправеното на това предупреждение може да доведе до токов удар или пожар.**



Не допускайте продуктът да бъде повреден от тежки предмети. **Неисправеното на това предупреждение може да доведе до токов удар или пожар.**



Ако продуктът издава странен звук, кърмима на изгорело или дим, незабавно изключете захранването и извадете щепсела от контакта. Ако изгответе продукта или повредите му, не бъдете покровени, незабавно изключете захранването и извадете щепсела от контакта. Не подменяйте продукта на същото място. **Това може да доведе до повреда на продукта или до пожар.**



Инсталирайте продукта на място с добра вентилация и на известно разстояние от стени. Инсталирайте на примера в среда, в която има вероятност от флуидиране, загарване, влага и колебание в температурата, или подлагането на примера на пренапрежение използвайте може да доведе до повреда. Планирането на вентилацията температура може да предотврати пожара. Съхранете от съприкосновение с който сте заредени продукти, **ако не сте сигурни, не се докосвайте продукта.**



Поставяйте продукта на фиксирано място, за да предотвратите преобръщането му. Когато преместите продукта, изключете захранването и изключете всички свързани кабели, включително и захранващия кабел. **В пропални случаи продуктът може да бъде повреден.**



Никога не разглобявайте, не ремонтирайте и не модифицирайте продукта самостоятелно, тъй като това ще аннулира гаранцията. **При необходимости ремонт се обръщайте към търговците, от които сте закупили продукта.**



Не допускайте в продукта да попадат чужди вещества. Не поставяйте тежки предмети, течности или метали върху продукта. **Това може да доведе до повреда на продукта или до пожар.**



Ако възникне проблем с продукта, се свържете с търговците, от които сте го закупили или се свържете с нас чрез страницата за ремонт на продуктите на уебсайта на BIXOLON (www.bixolon.com).



Lituanian

Bulgarian

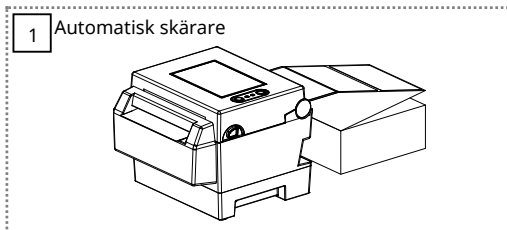
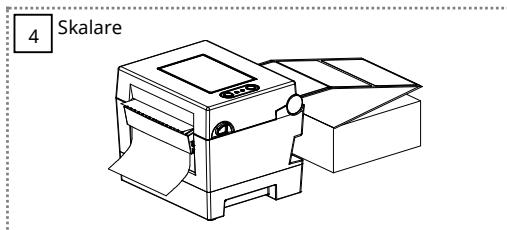
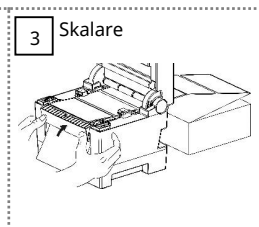
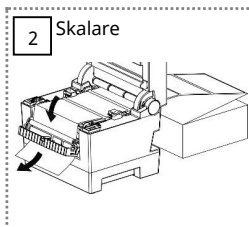
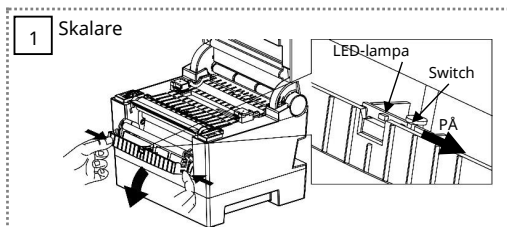
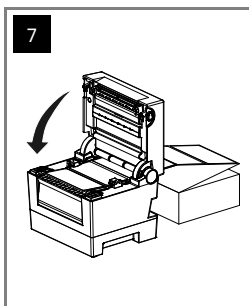
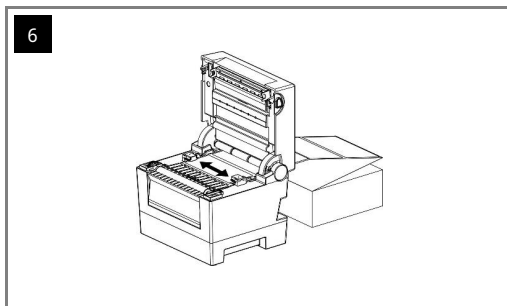
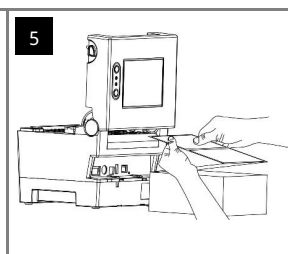
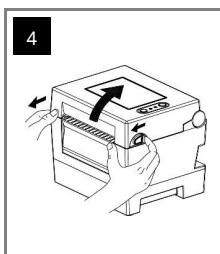
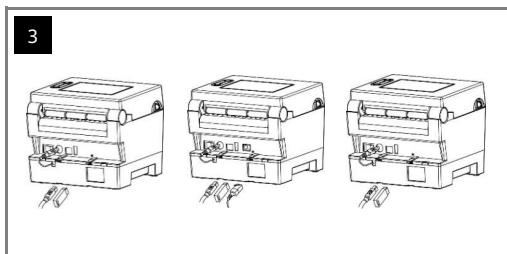
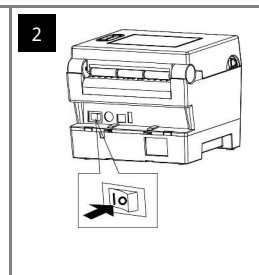
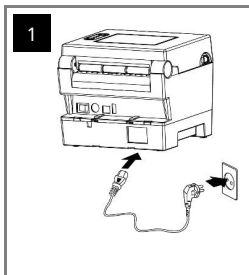
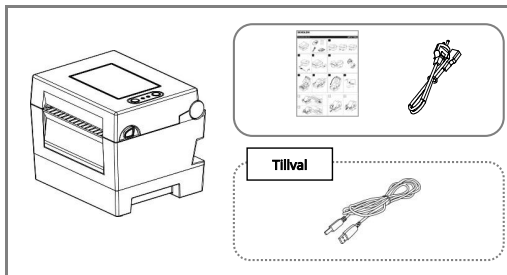

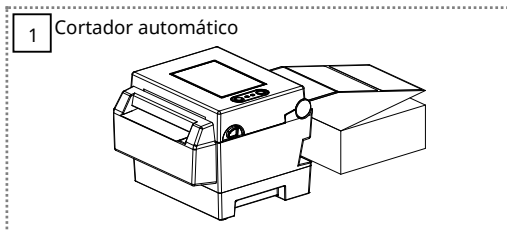
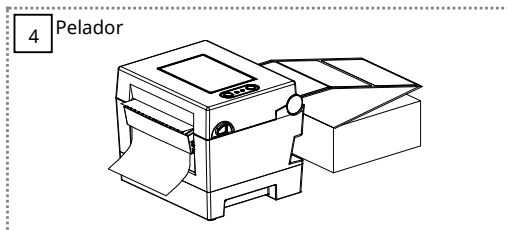
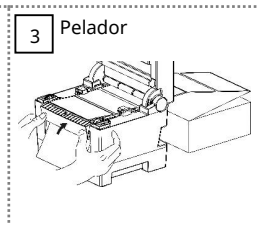
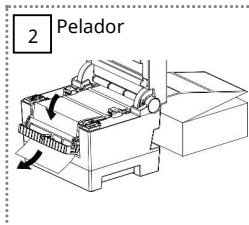
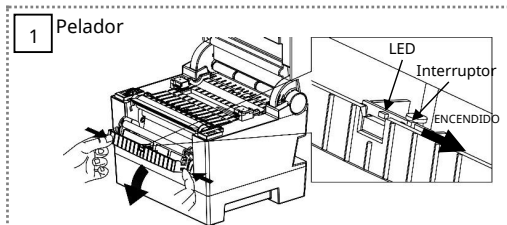
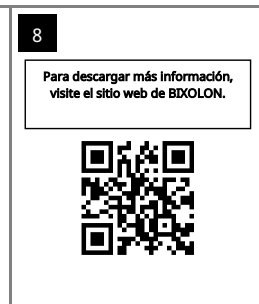
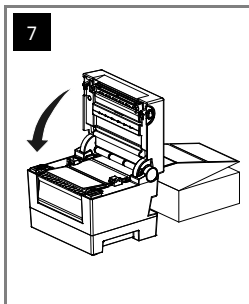
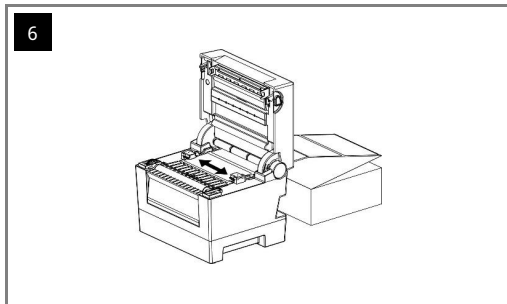
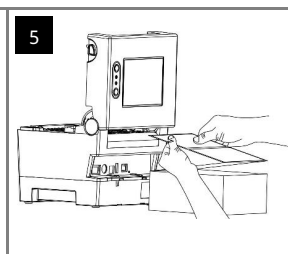
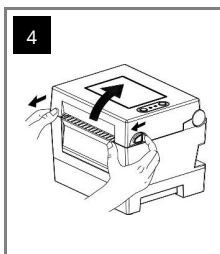
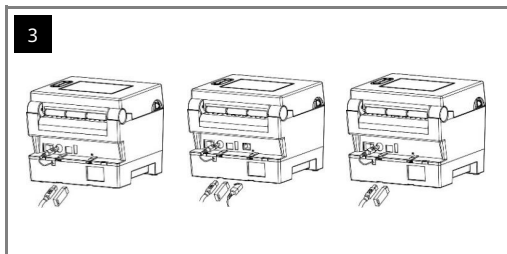
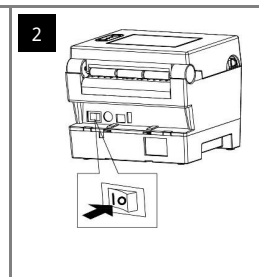
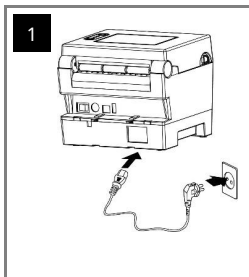
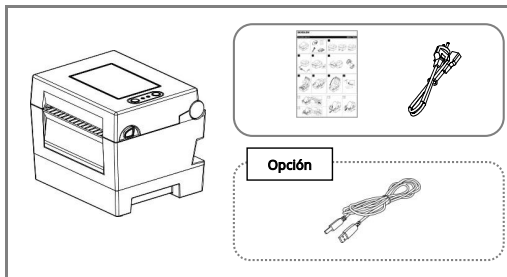

VARNING OCH FÖRSIKTIGHET

Beskrivs som dödsfall, fysiska skador, allvarig ekonomiska förlust och skada på data etc. som kan orsakas användaren.



Anslut inte flera produkter till samma, eller trasiga eluttag. Använd endast jordade eluttag som uppfyller branschstandarder. **Undermåliga eluttag kan orsaka elektriska stötar eller brand.**



Böj och belastar inte strömsladden för hårt. Tryck in strömsladden ordentligt i eluttaget, så att den inte sitter lös. Håll ordentligt i sladden när du tar ut den från eluttaget. Ta inte ut strömsladden medan produkten används. **Undermåliga eluttag kan orsaka elektriska stötar eller brand.**



Håll vätskor borta från strömsladden och uttaget. Torka av med en torr trasa om strömsladden blir smutsig. **Undermåliga eluttag kan orsaka elektriska stötar eller brand.**

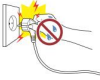

Om produkten avger underliga ljud, rökutsläpp eller synlig rök skall du stänga av strömmen omedelbart, och koppla ur strömsladden. Om produkten tappar eller dess stöda skadas skäl strömmen stängs av omedelbart och strömsladden dras ur. **Utsett inte produkten för stötar. Detta kan orsaka skador på produkten eller brand.**



Använd endast äkta BIXOLON-produkter. **Företaget kommer inte att tillhandahålla support efter försäljning för skadade produkter eller andra kvalitetsproblem på eventuella falska (eller reparerade) produkter.**



Håll små tillbehör och förpackningsmaterial borta från små barn. **Varning: kvävningsskada. Företag hantering av produkten kan orsaka skador som kan kräva akutvård.**



Låt inte produkten skadas av tunga föremål. **Undermåliga eluttag kan orsaka elektriska stötar eller brand.**



Installera produkten väl ventilerad, genom att placera den på en väst avsedd från väggen. Om produkten installeras på en plats med mycket damm, fukt och temperatursvängningar, eller om produkten används extremt kan det orsaka skador på skivorna. Om den interna temperaturen ökar kan det orsaka brand. **Kontakta alltid återförsäljaren om du är osäker på placering av produkten.**



Installera produkten på en stadigt yta så att den inte välter. Om produkten flyttas skall strömmen stängas av, och alla anslutna kablar, inklusive strömsladden, kopplas ur. **Dessa kan annars skada produkten.**



Demontera, reparera eller modifiera aldrig produkten själv, eftersom garantin då blir ogiltig. **Om produkten behöver repareras skall du kontakta den ursprungliga återförsäljaren.**



Låt inga främmande ämnen tränga in i produkten. Placera inte tunga föremål, vätskor eller metaller på produkten. **Detta kan orsaka skador på produkten eller brand.**



Om det uppstår problem med produkten ber vi dig kontakta den ursprungliga återförsäljaren, eller använda BIXOLON-webbplatsens sida för reparation av produkter (www.bixolon.com).



ADVERTENCIA Y PRECAUCIÓN

Se describe como muerte, lesiones físicas, pérdidas financieras graves y daños a los datos, etc., que puede sufrir el usuario.



No conecte varios productos a una toma de corriente única o defectuosa. Utilice únicamente tomas de corriente con conexión a tierra que cumplan con los estándares de la industria. **El incumplimiento puede provocar descargas eléctricas o incendios.**



No doble ni fuerce excesivamente el cable de alimentación. Empeque con seguridad el cable de alimentación hasta el fondo en la toma de corriente para que no quede suelto. Asegúrese de sujetar el cable con fuerza al separarlo de la toma de corriente. No retire el cable de alimentación mientras el producto está en uso. **El incumplimiento puede provocar descargas eléctricas o incendios.**



Mantenga el exceso de líquidos alejado del cable de alimentación y de la toma. Si se manchan los cables de alimentación, límpielos con un paño seco. **El incumplimiento puede provocar descargas eléctricas o incendios.**



Si el producto emite un sonido extraño, olor a quemado o humo, apágalo inmediatamente y desenchufe el cable de alimentación. Si el producto se calienta o exterior se deforma, apágalo inmediatamente y desenchufe el cable de alimentación. No someta el producto a golpes. **Esto podría causar daños al producto o un incendio.**



Utilice únicamente productos auténticos de BIXOLON. La empresa no proporcionará soporte posventa en caso de daños u otros problemas de calidad en los que pueda incurrir cualquier producto falso (o reaccionado).



Mantenga los accesorios pequeños u otros materiales de embalaje fuera del alcance de los niños pequeños. Cuidado: peligro de asfixia. **El mal manejo del producto puede provocar lesiones que pueden requerir atención médica urgente.**



No permita que el producto se dañe con objetos pesados. **El incumplimiento puede provocar descargas eléctricas o incendios.**



Instale el producto en un área bien ventilada manteniéndolo a una cierta distancia de la pared. Instale el producto en determinados entornos propensos a polvo excesivo, humedad y fluctuaciones de temperatura o someter el producto a un uso extremo puede provocar daños a la impresión. Un aumento de la temperatura interna puede provocar un incendio. **Asegúrese de comunicarse con el lugar de compra si no está seguro de la ubicación del producto.**



Instale el producto en un lugar fijo para evitar que se vuelque. Cuando mueva el producto, apague y desconecte todos los cables conectados, incluido el cable de alimentación. **Puede dañar el producto.**



Nunca desmonte, repare o modifique el producto de forma independiente, ya que la garantía dejará de ser válida. **Cuando sea necesaria una reparación, comuníquese con el lugar de compra original.**



No deje que ninguna sustancia extraña entre en el producto. No coloque objetos pesados, líquidos o metales sobre el producto. **Esto podría causar daños al producto o un incendio.**



Si hay un problema con el producto, comuníquese con el lugar de compra original o a través de la página de reparación del producto del sitio web de BIXOLON (www.bixolon.com).



Swedish

Spanish

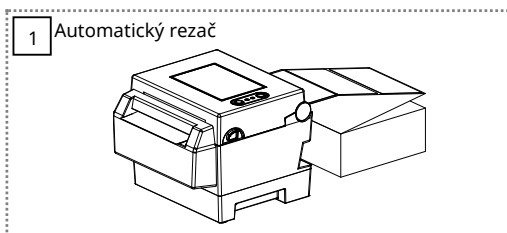
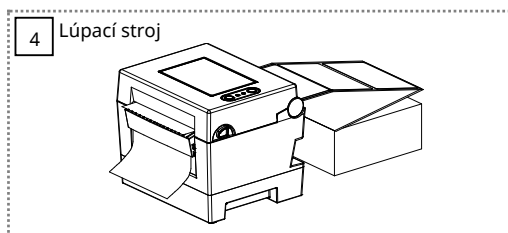
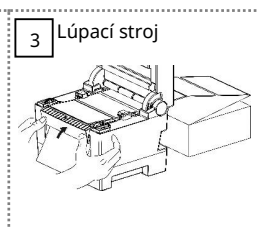
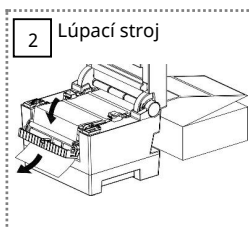
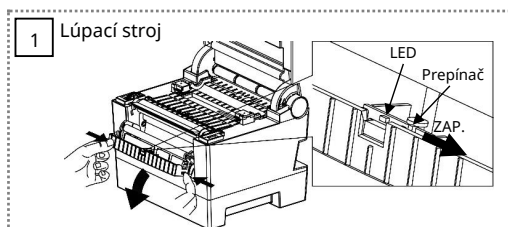
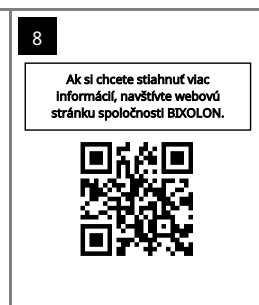
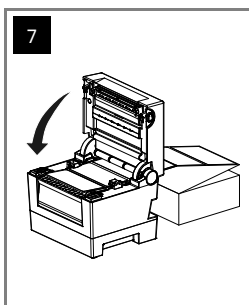
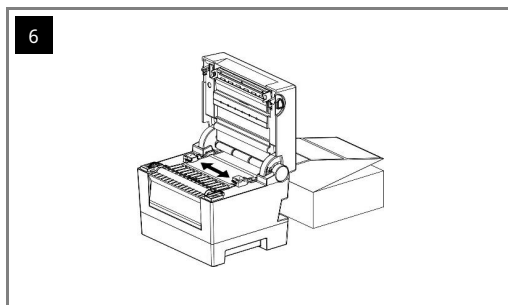
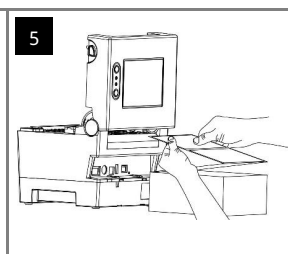
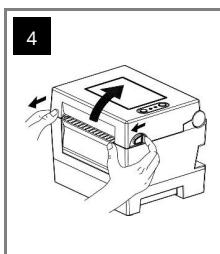
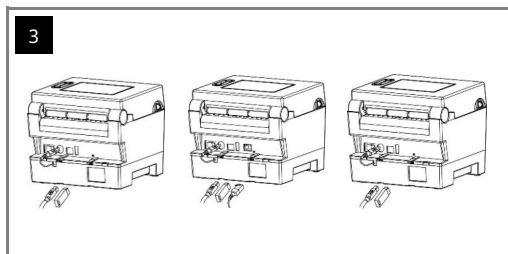
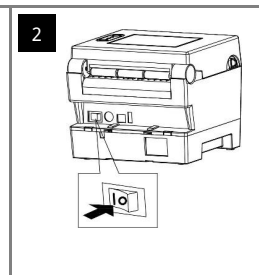
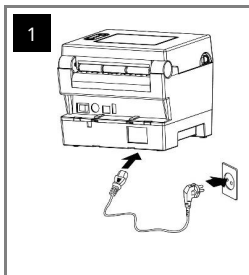
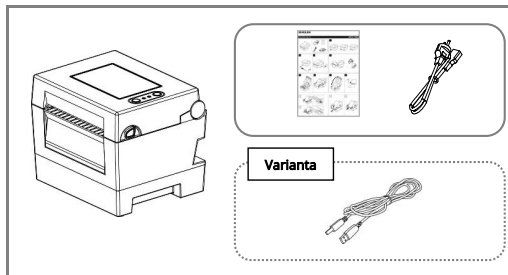

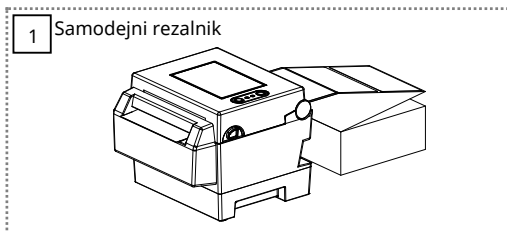
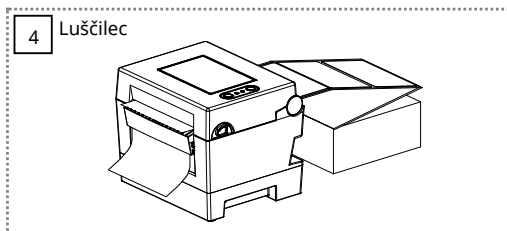
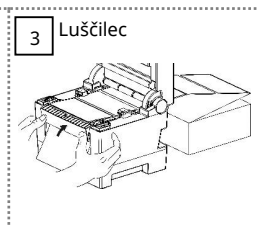
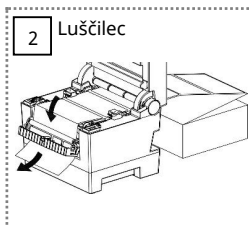
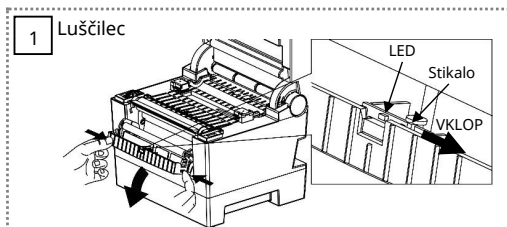
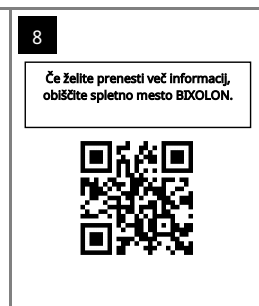
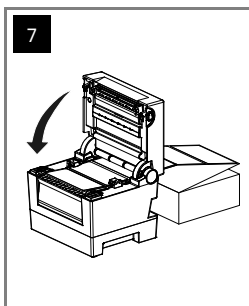
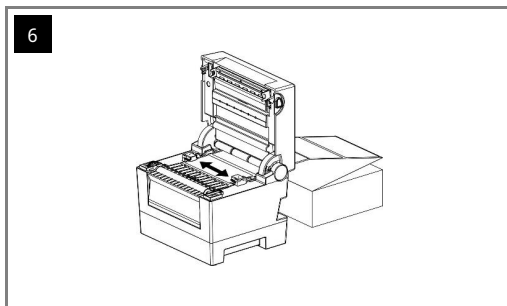
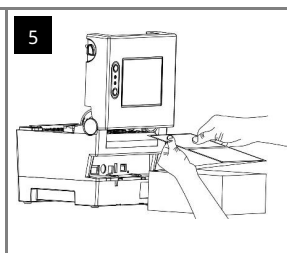
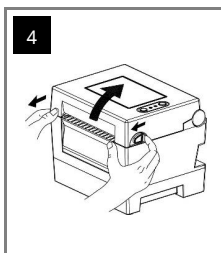
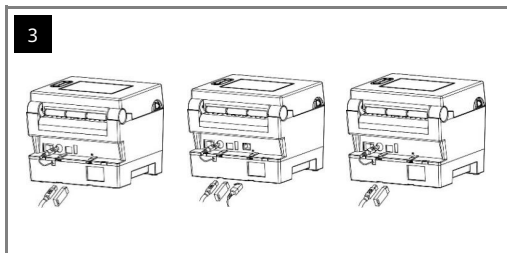
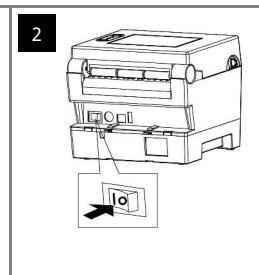
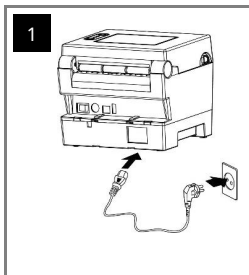
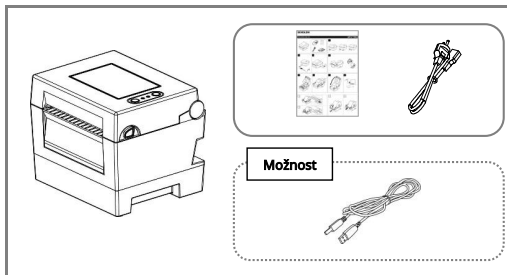



VAROVANIE A UPOZORNENIE

Je opísaný ako smrť, fyzické zranenia, vážne finančné straty, poškodenie údajov atď., ktoré môžu byť spôsobené používateľovi.

Nepripájajte viacero výrobkov do jednej alebo chýbnej elektrickej zásuvky. Používajte iba uzemnené elektrické zásuvky, ktoré spĺňajú normu odvetvia. **Nedodržanie pravidiel môže spôsobiť úraz elektrickým prúdom alebo požiar.**



Používajte iba autentické produkty spoločnosti BIXOLON. **Spoločnosť nebude poskytovať podporu po predaji v prípade poškodených alebo iných porúchov s kvalitou, ktoré môžu vzniknúť falšovaným (alebo renovovaným) výrobkom.**



Napájajte kábel nadmerne nehybatne ani nenamáhajte. Bezpečne zatlačte napájací kábel úplne do elektrickej zásuvky, aby nezostali voľný. Pri vyťahovaní kábla z elektrickej zásuvky ho pevne držte. Počas používania výrobku napájací kábel neodstavte. **Nedodržanie pravidiel môže spôsobiť úraz elektrickým prúdom alebo požiar.**



Malé doplnky alebo iné obalové materiály uchovávajte mimo dosahu malých detí. Pozor: nebezpečenstvo udusenia. **Nesprávna manipulácia s výrobkom môže spôsobiť zranenia, ktoré si môžu vyžadovať naliehavú lekársku pomoc.**



Prebytočné tekutiny uchovávajte mimo dosahu napájacieho kábla a zásuvky. Ak je na napájacie káble rozmazaná hmota, utrite suchou handričkou. **Nedodržanie pravidiel môže spôsobiť úraz elektrickým prúdom alebo požiar.**



Nedovoľte, aby bol výrobok poškodený ťažkými predmetmi. **Nedodržanie pravidiel môže spôsobiť úraz elektrickým prúdom alebo požiar.**



Ak výrobok vydáva zvláštny zvuk, zápach palenia alebo dym, okamžite vypnite napájanie a odpojte napájací kábel. Ak výrobok spadne alebo sa poškodí jeho vonkajšia strana, okamžite vypnite napájanie a odpojte napájací kábel. **Nevystavujte výrobok nárazom. Mohlo by to spôsobiť poškodenie výrobku alebo požiar.**



Výrobok inštalujte na dobre vetranom mieste tak, že ho budete udržiavať voľným odtokom od tepla. Inštalácia výrobkov v utroch a priotrádka, ktoré sú ťažké na nastavení prítlačnosti, vyvolávajú tepelnú výhrev, alebo nesprávne používanie výrobku môže spôsobiť jeho poškodenie. Zlyhanie vzdušnej čističky môže spôsobiť požiar. **Nesprávne umiestnenie miesta nájdu, ak si nie ste istí umiestnením produktu.**



Nainštalujte výrobok na pevné miesto, aby ste zabránili jeho prevráteniu. Pri premiestňovaní výrobku vypnite napájanie a odpojte všetky pripojené káble vrátane napájacieho kábla. **Pretože by to mohlo poškodiť výrobok.**



Produkt nikdy samostatne nerozoberajte, neopravujte ani neupravujte, pretože záruka zanikne. **Ak je potrebná oprava, obráťte sa na pôvodné miesto nákupu.**



Nedovoľte, aby do výrobku vnikli žiadne cudzie látky. Na výrobok neumiestňujte ťažké predmety, kvapaliny ani kovy. **Mohlo by to spôsobiť poškodenie výrobku alebo požiar.**



Ak sa vyskytne problém s produktom, obráťte sa na pôvodné miesto nákupu alebo prostredníctvom stránky opravy produktu na webovej stránke spoločnosti BIXOLON (www.bixolon.com).



Slovak



OPOZORILO IN PREVIDNOST

To pomeni smrt, telesne poškodbe, hude finančne izgube in poškodbe podatkov itd., ki jih lahko povzroči uporabnik.

Ne priključite več izdelkov na eno ali pokvarjeno vtičnico. Uporabljajte le omejenje vtičnice, ki ustrezajo industrijskim standardom. **Neupoštevanje navedenega lahko povzroči električni udar ali požar.**



Uporabljajte samo pristine izdelke družbe BIXOLON. **Podjetje ne bo zagotovo prodajalne podpore za poškodovane izdelke ali druge težave s kakovostjo, ki jih lahko povzročijo ponarejeni (ali obnovljeni) izdelki.**



Napájalnega kábla ne upogibajte ali nesprijajate prevod. Napájací kábel dobro potlačite povsem v električno vtičnico, da ne ostane zrahljan. Poskrbite, da kábel ob iztiskanju iz vtičnice trdno držite. Ne odstavljajte napájalnega kábla, ko je izdelek v uporabi. **Neupoštevanje navedenega lahko povzroči električni udar ali požar.**



Majhne dodatke ali drugo embalažo hranite izven dosega malih otrok. **Prezračite: Nepravilno ravnanje z izdelkom lahko povzroči telesne poškodbe, ki lahko zahtevajo nujno zdravniško pomoč.**



Ne približujte večje količine tekočin napajalnemu káblu in vtičnici. Če se po napajalnih káblu razmaže snov, jih obrišite s suho krpo. **Neupoštevanje navedenega lahko povzroči električni udar ali požar.**



Ne dopustite, da bi izdelek poškodovani težki predmeti. **Neupoštevanje navedenega lahko povzroči električni udar ali požar.**



Če izdelek oddaja nenavaden zvok, vonj po zažganem ali dym, takoj izklopite napajanje in izklopite napajalni kábel. Če vam izdelek pade ali se poškoduje njegova zunanja stran, takoj izklopite napajanje in izklopite napajalni kábel. Izdelek ne izpostavljajte udarcem. **To lahko povzroči poškodbe izdelka ali požar.**



Izdelek namestite na dobro prezračevano mesto, pri čemer ohranite dovoljeno razdaljo med izdelkom in steno. Namestitev izdelka v neventiliranem okolju, ki so nagnjena k čezmernemu nastajanju prahu, vlage in temperaturnim nihanjem ali izpostavljenosti izdelka elektrini in uporabi lahko povzročijo požar. **Če niste prepričani glede namestitve izdelka, se obrnite na mesto nakupa.**



Izdelek namestite na fikсно mesto, da preprečite prevrnitev. Pred premikanjem izdelka izklopite napajanje in izklopite vse priključene káble, vključno z napajalnim káblom. **Če tega ne storite, se izdelek lahko poškoduje.**



Nikoli samostojno ne razstavljajte, popravljajte ali spreminjajte izdelka, ker to izniči garancijo. **Če je potrebno popravilo, se obrnite na prvotno mesto nakupa.**



Preprečite vstop tujih snovi v izdelek. Na izdelek ne postavljajte težkih predmetov, tekočin ali kovin. **To lahko povzroči poškodbe izdelka ali požar.**



Če pride do težave z izdelkom, se obrnite na prvotno mesto nakupa ali obiščite stran za popravilo izdelkov na spletnem mestu BIXOLON (www.bixolon.com).



Slovenian

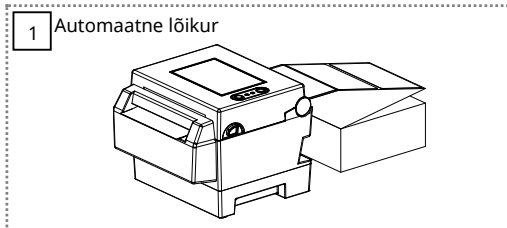
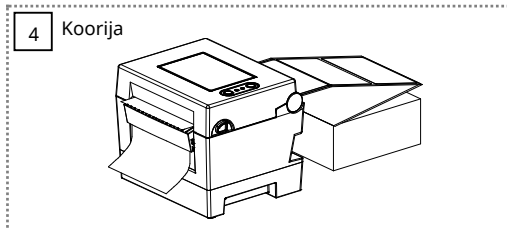
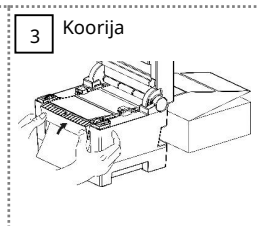
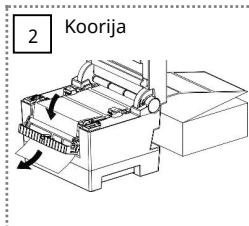
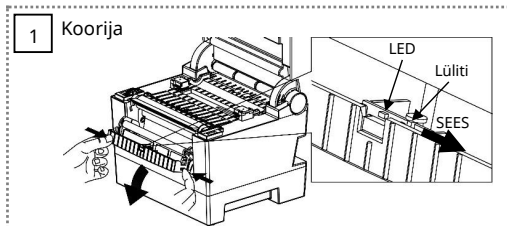
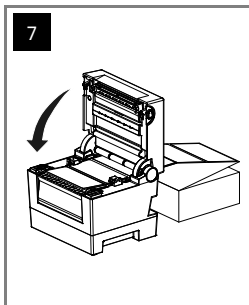
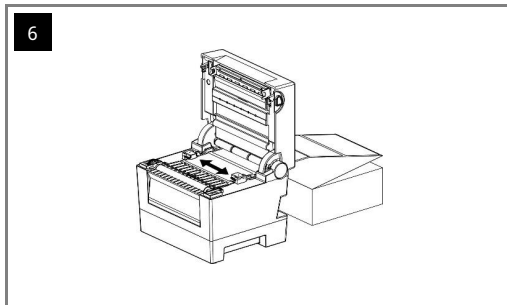
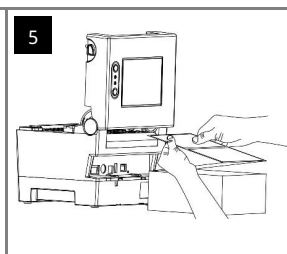
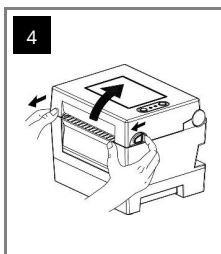
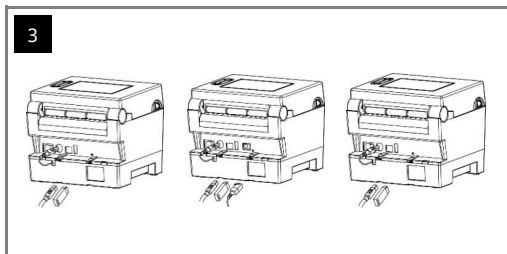
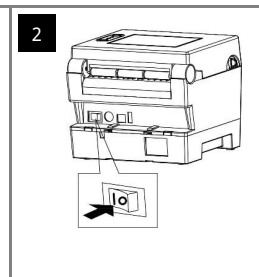
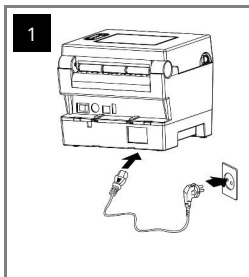
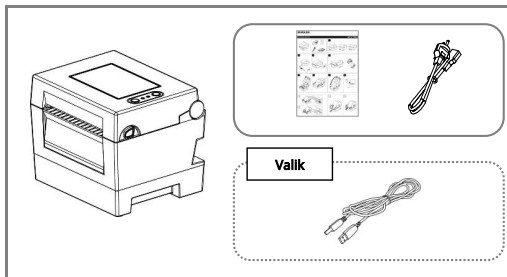

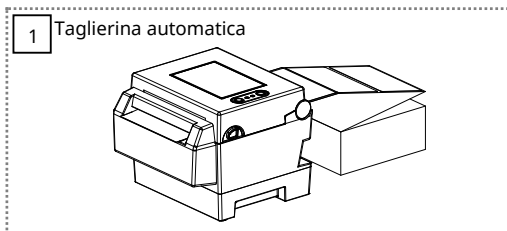
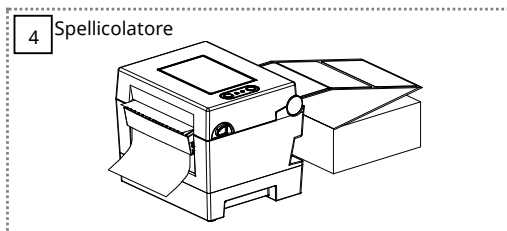
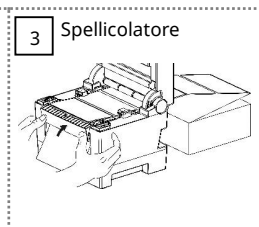
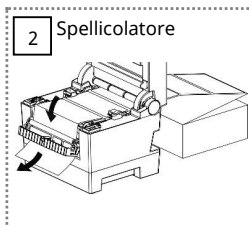
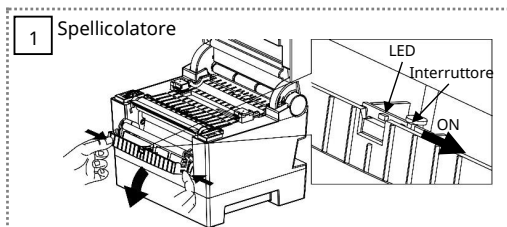
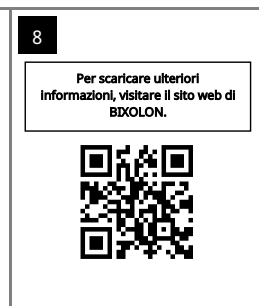
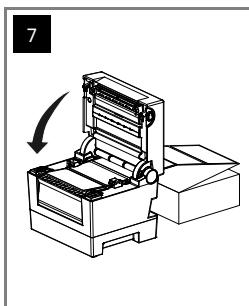
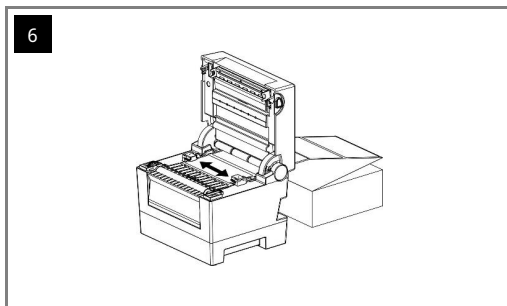
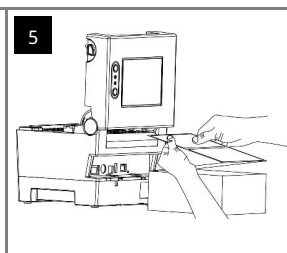
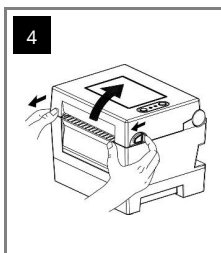
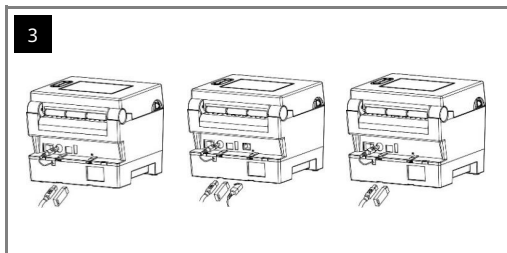
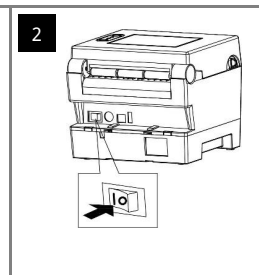
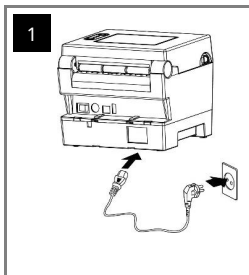
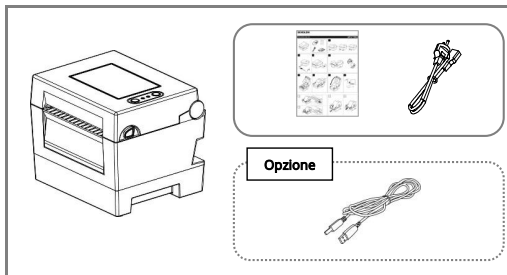



HOIATUS JA ETTEVAATUST

Seda kirjeldatakse kui surma, kehavigastusi, tõsiseid rahalisi kaotusi, andmete kahjustamist jne, mida kasutaja võib põhjustada.



AVVERTENZA E CAUTELA

Si intende il rischio di morte, lesioni fisiche, gravi perdite economiche, danni ai dati, ecc. che possono essere arrecati all'utente.

Ärge ühendage miit toodet ühe või vigase pistikupesaga. Kasutage ainult tootstandardele vastavaid maandatud pistikupesaid. **Mittevastavus võib põhjustada elektrilöögi või tulekahju.**



Kasutage ainult autentsed BIXOLONI tooteid. **Ettevõtte ei paku müügilõigset tuge kahjustatud ega muude kvaliteediprobleemide korral, mis võivad tekkida võitluse (või kaasatuse) tootest.**



Non collegare più di un dispositivo a una singola presa di corrente o a una presa difettosa. Utilizzare solo prese di corrente con messa a terra conformi agli standard industriali. **La mancata osservanza di queste regole può causare scosse elettriche o incendi.**



Utilizzare solo prodotti autentici di BIXOLON. **L'azienda non fornirà assistenza post-vendita per i danni o altri problemi di qualità che potrebbero verificarsi con i prodotti falsi (o ricondizionati).**



Ärge painutage ega pingutage toitejuhet liigselt. Lükake toitejuhet kindlalt lõpuni pistikupesasse, et see lahti ei jääks. Hoidke juhet kindlalt kinni, kui eemaldate selle vooluvõrgust. Ärge eemaldage toitejuhet tootse kasutamise ajal. **Mittevastavus võib põhjustada elektrilöögi või tulekahju.**



Hoidke väikesed tarvikud või muud pakematerjalid väikekastest eemal. Ettevaatust: äärmuslikult. **Toote võib läbepõlgnemise võib põhjustada vigastusi, mis võivad vajada kiiret arstiabi.**



Non piegare o sfiorare eccessivamente il cavo di alimentazione. Spegnerlo saldamente il cavo di alimentazione fino in fondo nella presa di corrente per evitare che rimanga allentato. Assicurarsi di tenere il cavo ben saldo quando lo si stacca dalla presa di corrente. Non rimuovere il cavo di alimentazione mentre il dispositivo è in uso. **La mancata osservanza di queste regole può causare scosse elettriche o incendi.**



Tenere i piccoli accessori o altri materiali di imballaggio lontano dalla portata dei bambini. Avvertenza: pericolo di soffocamento. **L'uso improprio del dispositivo può provocare lesioni che possono richiedere l'intervento urgente di un medico.**



Hoidke liigsed vedelikud toitejuhetest ja pistikupesast eemal. Kui toitejuhetele on määratud ainet, pühkige seda kuiva lapiga. **Mittevastavus võib põhjustada elektrilöögi või tulekahju.**



Ärge laske rasketel esemetel toodet kahjustada. **Mittevastavus võib põhjustada elektrilöögi või tulekahju.**



Tenere i liquidi in quantità eccessiva lontano dal cavo di alimentazione e dalla presa di corrente. Eventuali impurità sui cavi di alimentazione devono essere pulite con un panno asciutto. **La mancata osservanza di queste regole può causare scosse elettriche o incendi.**



Non lasciare che il dispositivo venga danneggiato da oggetti pesanti. **La mancata osservanza di queste regole può causare scosse elettriche o incendi.**



Kui toode eraladab kummalist heli, põlemisõhna või suitsu, lülitage kohe toode välja ja eemaldage toitejuhet. Kui toode kukub maha või selle väljagand on kahjustatud, lülitage kohe toode välja ja eemaldage toitejuhet. Ärge laske toode põruda. **See võib kahjustada toodet või põhjustada tulekahju.**



Paiakäidage toode hästi ventileeritava kohta, hoides seda kindlalt kaugusest seest. Toote paigaldamine teatud keskkondades, mis on alati liigese tolmuse, riskuste ja temperatuurikikumistete, või toote äärmuslik kasutamine võivad põhjustada kahjustusi. Sisemise temperatuurilõõs võib põhjustada tulekahju. Võtke kindlasti otsekohe ühendust, kui te pole toote paigutuses kindel.

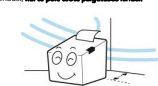

Se il dispositivo emette suoni strani, odore di bruciato o fumo, spegnerlo immediatamente e scollegare il cavo di alimentazione. Se il dispositivo cade o viene danneggiato all'esterno, spegnerlo immediatamente e scollegare il cavo di alimentazione. **Non sottoporre il dispositivo a urti. Ciò potrebbe provocare danni al dispositivo o un incendio.**



Installare il dispositivo in un'area ben ventilata, tenendolo a una certa distanza dalla parete. L'installazione dello stampante in determinati ambienti esposti a un'eccessiva presenza di polvere, umidità e fluttuazioni di temperatura o in uno particolarmente inteso dalla stessa può provocare danni al dispositivo. Un aumento della temperatura interna può provocare un incendio. **Se non si è sicuri della collocazione del dispositivo, contattare il negozio in cui esso è stato acquistato.**



Paiakäidage toode kindlas kohas, et vältida selle ümbermükkumist. Toote teisel detsimeil lülitage toode välja ja lahutage kõik ühendatud kaablid, sealhulgas toitejuhet. **Kuna see võib toodet kahjustada.**



Ärge kunagi võtke toodet iseseisvalt lahti, parandage ega muutke seda, kuna garantii kaotab kehtivuse. **Kui remont on vajalik, võtke ühendust algse ostukohaga.**



Installare il dispositivo in un luogo fisso per prevenirne il ribaltamento. Quando si sposta il dispositivo, spegnere l'alimentazione e scollegare tutti i cavi collegati, compreso il cavo di alimentazione. **In caso contrario, si rischia di danneggiare il dispositivo.**



Non smontare, riparare o modificare il prodotto per conto proprio, poiché ciò farebbe decadere la garanzia. **Qualora si renda necessaria una riparazione, rivolgersi al rivenditore originale.**



Ärge laske võõrkehadel tootesse sattuda. Ärge asetage tootele raskeid esemeid, vedelikke ega metalle. **See võib kahjustada toodet või põhjustada tulekahju.**



Kui tootega on probleeme, võtke ühendust algse ostukohaga või BIXOLONI veebisaidil toote remondilehe kaudu (www.bixolon.com).
3



Non far penetrare sostanze estranee nel dispositivo. Non collocare oggetti pesanti, liquidi o metalli sul dispositivo. **Ciò potrebbe provocare danni al dispositivo o un incendio.**



In caso di problemi con il dispositivo, contattare il rivenditore originale o la pagina di assistenza tecnica del sito web (www.bixolon.com).



Italian

Italian

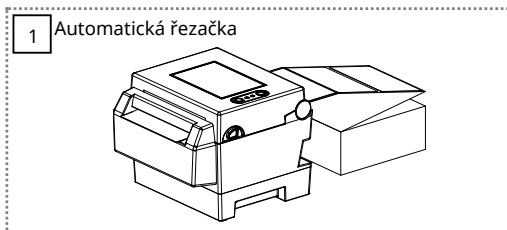
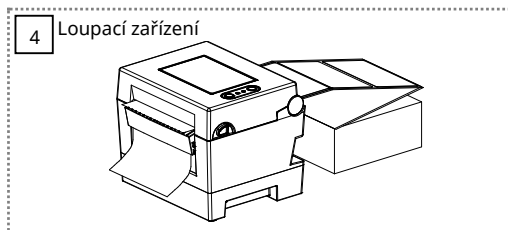
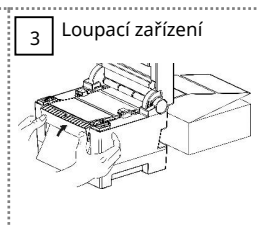
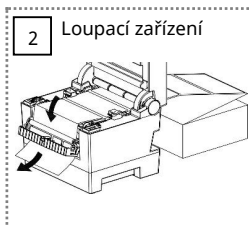
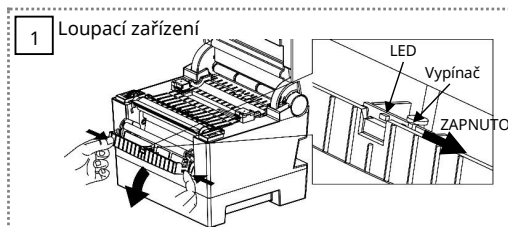
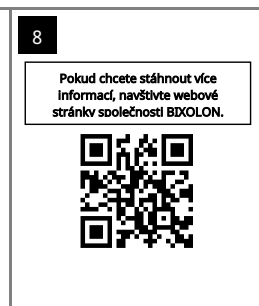
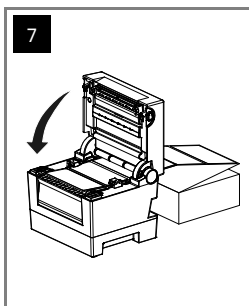
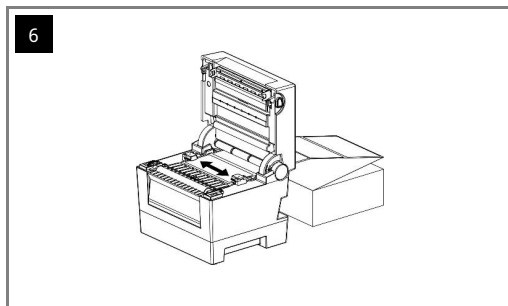
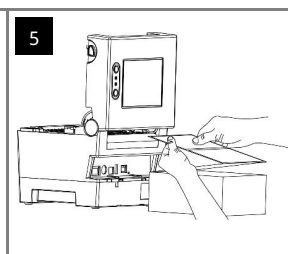
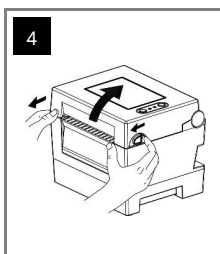
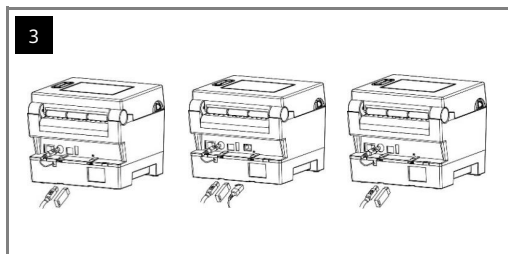
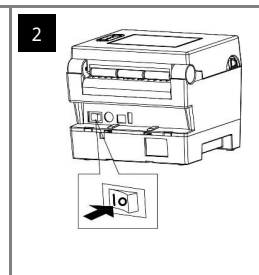
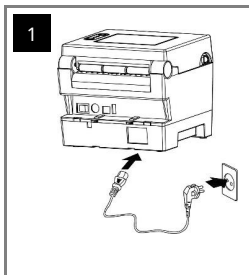
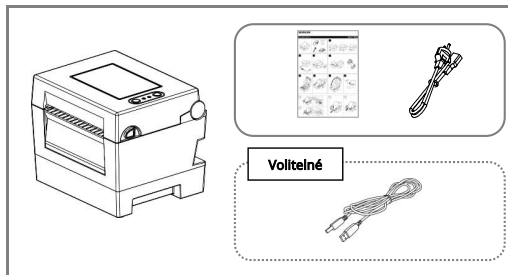

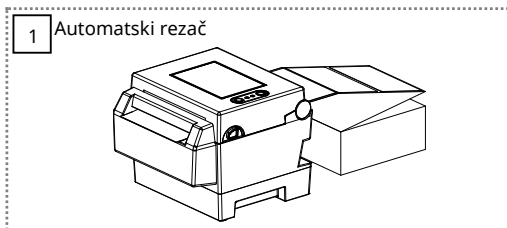
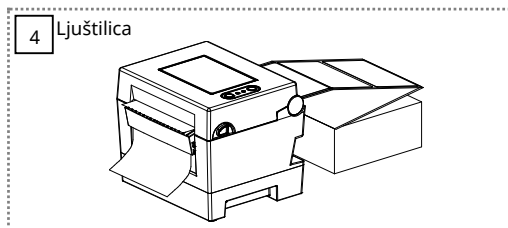
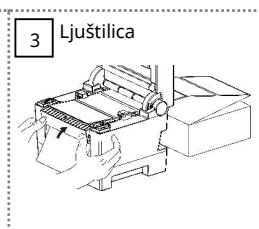
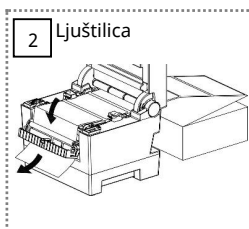
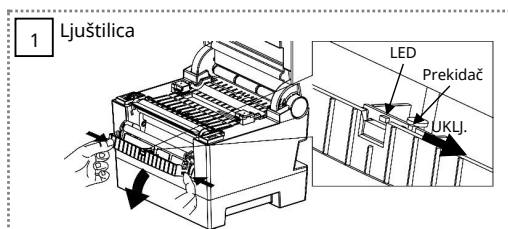
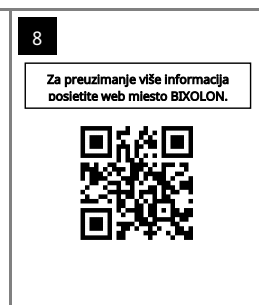
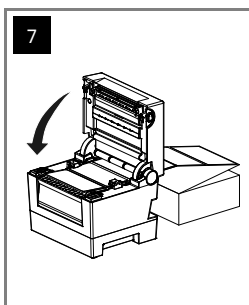
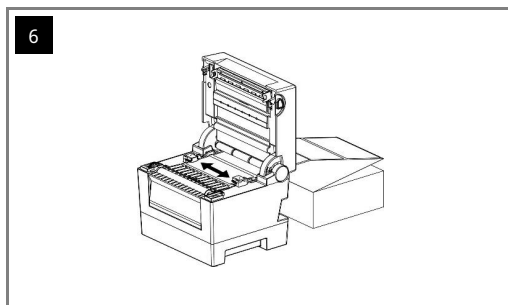
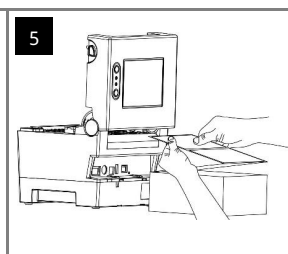
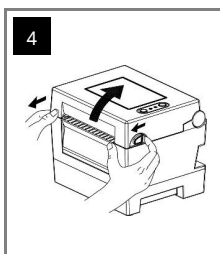
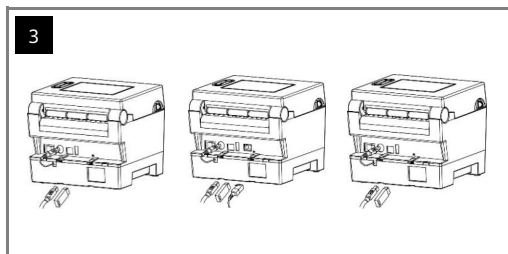
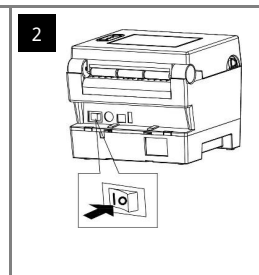
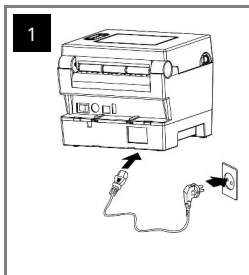
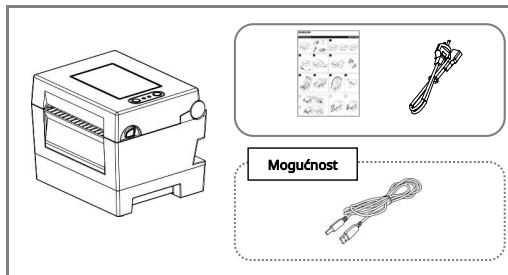



VAROVÁNÍ A UPOZORNĚNÍ

Popisuje se jako smrt, fyzické zranění, vážné finanční ztráty a poškození dat atd., které mohou být způsobeny uživateli.

Ne připojujte více produktů do jedné nebo vadné zásuvky. Používejte pouze uzemněné zásuvky, které splňují normy daného odvětví. **Nedodržení může způsobit úraz elektrickým proudem nebo požár.**



Používejte pouze autentické produkty společnosti BIXOLON. **Společnost neposkytuje podporu po prodejí v případě poškození nebo jiných problémů s kvalitou. Někdy se mohou vyskytnout u padělků (nebo nepovolených) výrobků.**



Napájecí kabel přilepte neohybně ani nenamáhejte. Napájecí kabel bezpečně do zásuvky zasuněte až na doraz, aby neudržel volně. Při odpojování kabelu od zásuvky kabel pevně držte. **Neopojujte napájecí kabel, pokud je v produktu v provozu. Nedodržení může způsobit úraz elektrickým proudem nebo požár.**



Drobné příslušenství a obalové materiály uchovávejte mimo dosah malých dětí. Hrozi nebezpečí udusení. **Při nesprávném manipulaci s produktem může dojít k poranění, které může vyžadovat pomoc lékaře.**



Tekutiny uchovávejte mimo dosah napájecího kabelu a zásuvky. Pokud se na napájecích kabelech objeví nečistoty, otřete je suchým hadříkem. **Nedodržení může způsobit úraz elektrickým proudem nebo požár.**



Nedovolojte, aby došlo k poškození produktu železnými předměty. **Nedodržení může způsobit úraz elektrickým proudem nebo požár.**



Pokud produkt vydává podivný zvuk, zádech spáleniny nebo se z něj kouří, okamžitě vypněte napájení a odpojte napájecí kabel. Pokud produkt vypadá nebo dýchá poškozeným jeho vnější část, okamžitě vypněte napájení a odpojte napájecí kabel. Nevystráňte produkt nárazem. **Mohlo by to způsobit poškození produktu nebo požár.**



Produkt instalujte na dobře větraném místě v dostatečné vzdálenosti od stěny. Instalace produktu v uzavřených prostorech, která jsou nablízka k nadměrně vysoké vlhkosti, prachu, vlnitosti a teplotním výkyvům, nebo systémem výroby extrémně nízké vlhkosti může způsobit poškození tělesného. Zvýšení vnitřní teploty může způsobit požár. **Pokud si nejste jisti umístěním produktu, neptejte se v místě jeho zakoupení.**



Produkt instalujte na pevné místo, aby se nepřevlétl. Při přemístění produktu vypněte napájení a odpojte všechny připojené kabely včetně napájecího kabelu. **Mohlo by dojít k poškození produktu.**



Nikdy produkt sami nerozebírejte, neopravujte ani neupravujte, protože by tím zanikla záruka. **V případě nutnosti opravy se obraťte na místo, kde jste jej zakoupili.**



Do produktu nesmí proniknout žádné cizí látky. Nepokládejte na produkt těžké předměty, tekutiny ani kovy. **Mohlo by to způsobit poškození produktu nebo požár.**



Pokud se vyskytne problém s produktem, obraťte se na místo, kde jste jej zakoupili, nebo na stránku pro opravu produktů na webových stránkách společnosti BIXOLON (www.bixolon.com).



UPOZORNĚNÍ I OPREZ

Opisuje se kao smrt, fizičke ozljede, ozbiljni finansijski gubici i oštećenje podataka itd. koji se mogu prouzročiti korisniku.

Ne spajajte više proizvoda na jednu ili neispravnu utičnicu. Koristite samo uzemljene utičnice koje zadovoljavaju industrijski standard. **Neskladnost može uzrokovati strujni udar ili požar.**



Koristite samo autentične proizvode BIXOLON. **Tvrđka neće pružiti podršku nakon prodaje za oštećenje ili druge probleme s kvalitetom koje mogu izazvati bilo koji lažni (ili obnovljeni) proizvod.**



Nemojte preterano savijati ili zatezati kabel za napajanje. Čvrsto gumite kabel za napajanje do kraja u utičnicu kako ne bi ostao labav. Pazite da čvrsto držite kabel kada ga odvajate od utičnice. Nemojte uklanjati kabel za napajanje dok je proizvod u uporabi. **Neskladnost može uzrokovati strujni udar ili požar.**



Držite male dodatke ili druge materijale za pakiranje dalje od male djece. **Oprez: opasnost od gušenja. Pogrešno rukovanje proizvodom može dovesti do oštećda koje mogu zahtijevati hitnu liječničku pomoć.**



Držite prekomjerne tekućine podalje od kabela za napajanje i utičnice. Ako je mrlja razmazana po kabelima za napajanje, obrišite ih suhom krpom. **Neskladnost može uzrokovati strujni udar ili požar.**



Nemojte dopustiti da se proizvod ošteti teškim predmetima. **Neskladnost može uzrokovati strujni udar ili požar.**



Ako proizvod emitira neobičan zvuk, miris paljivine ili dim, odmah isključite napajanje i izvucite kabel za napajanje. Ako proizvod padne ili mu se vanjski dio ošteti, odmah isključite napajanje i izvucite kabel za napajanje. Ne usajte proizvod udarcima. **To bi moglo uzrokovati oštećenje proizvoda ili požar.**



Instalirajte proizvod u dobro prozračenom prostoru održavajući ga na određenoj mjestu udaljenosti od stene. Ugradište proizvod u određena okruženja koja su sklana prekomjernoj vlhkosti, visoki temperaturi, bluznastim ili prašnjavim proizvodima u ekstremnu uporabu može oštetiti pisat. **Povlačenje unutarnje temperature može izazvati požar. Obavljeno koristeći napredno ispažnje ako nije sigurno u pitanju premjena proizvoda.**



Postavite proizvod na fiksno mjesto kako biste spriječili njegovo prevrtanje. Kada premještate proizvod, isključite napajanje i odspojite sve spojene kabele, uključujući kabel za napajanje. **Naime, može oštetiti proizvod.**



Nikada nemojte samostalno rastavljati, popravljati ili modificirati proizvod jer će jamstvo prestati vrijediti. **Ako je potreban popravak, obratite se izvornom mjestu kupnje.**



Ne dopuštajte da strane stvari uđu u proizvod. Ne stavljajte teške predmete, tekućine ili metale na proizvod. **To bi moglo uzrokovati oštećenje proizvoda ili požar.**



Ako postoji problem s proizvodom, obratite se izvornom mjestu kupnje ili putem web mjesta za popravak proizvoda BIXOLON (www.bixolon.com).



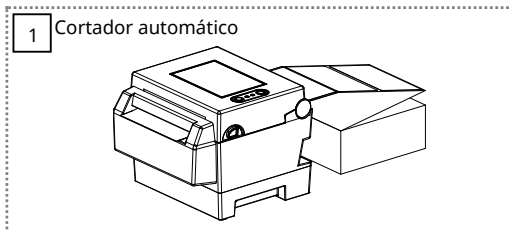
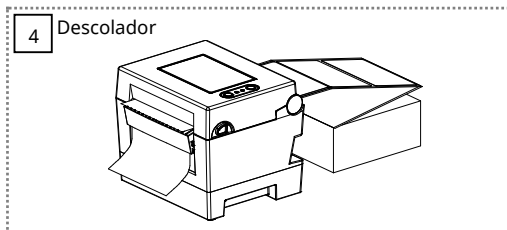
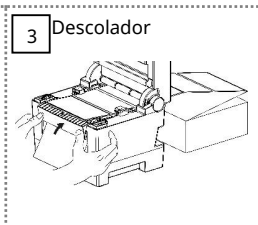
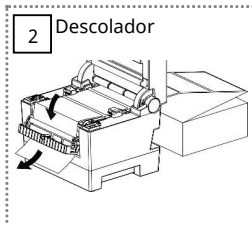
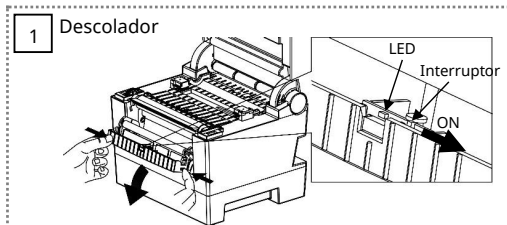
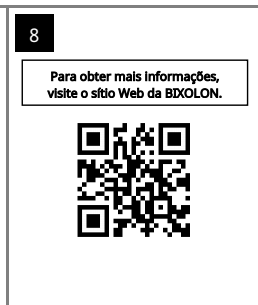
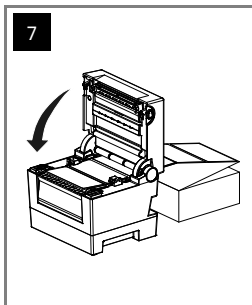
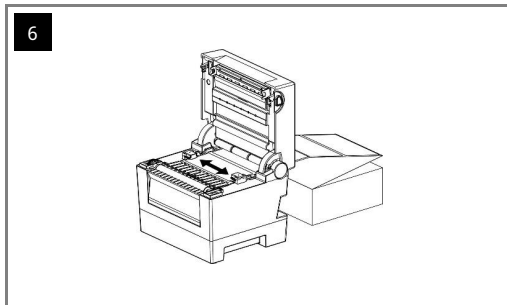
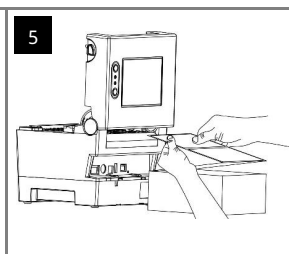
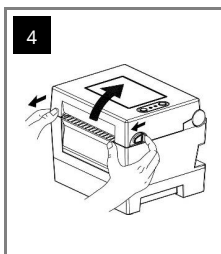
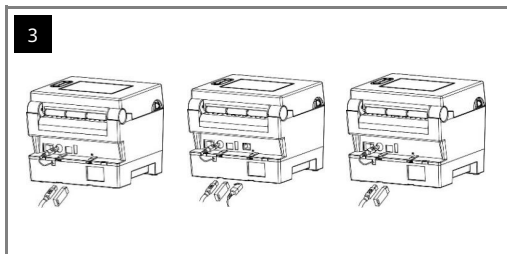
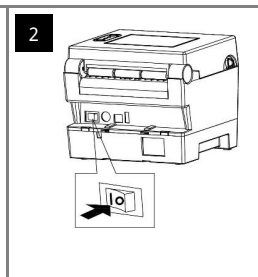
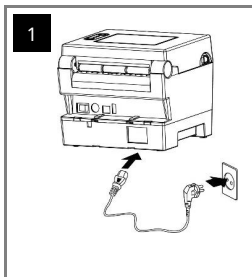
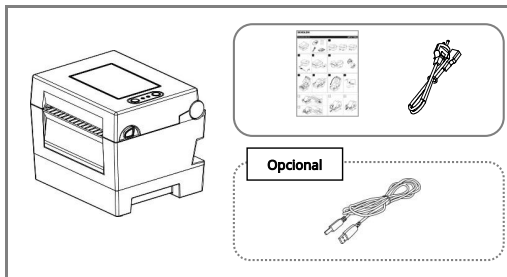

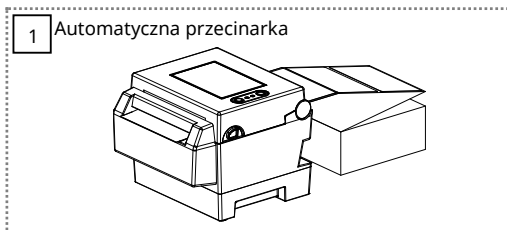
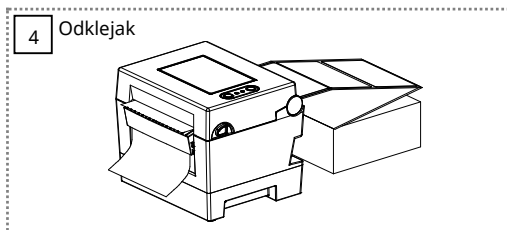
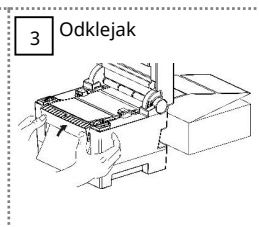
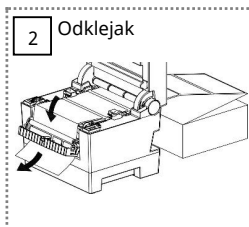
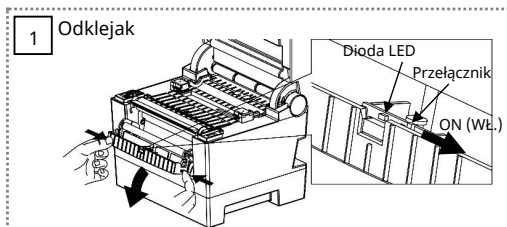
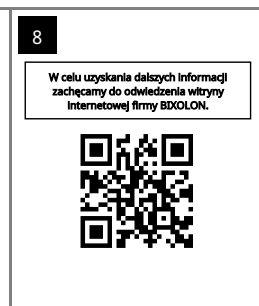
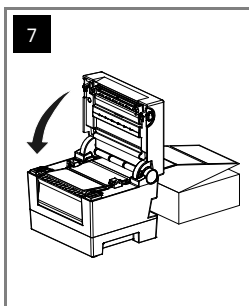
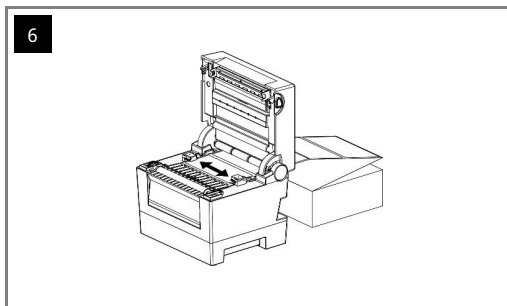
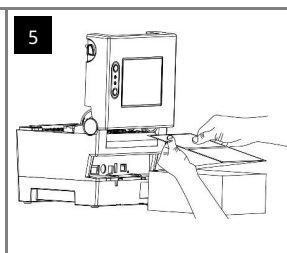
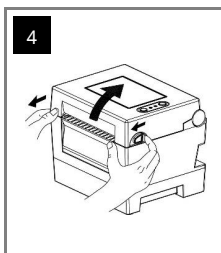
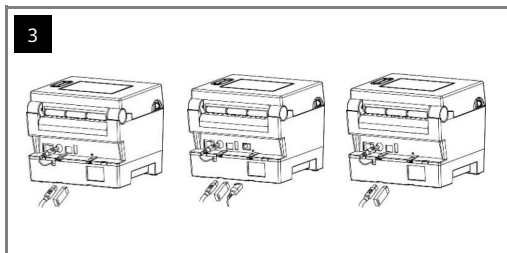
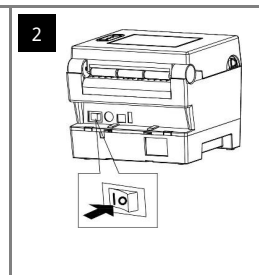
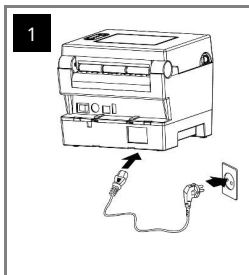
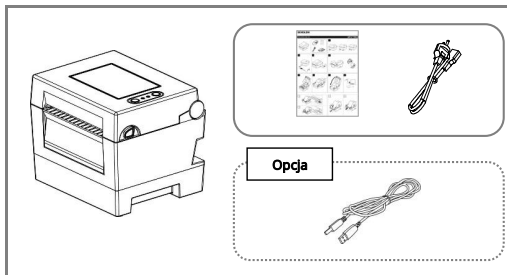



AVISO E CUIDADO

É descrito como situações como morte, ferimentos, prejuízos financeiros de grande monta e danos nos dados, entre outros, que podem ser causados ao utilizar o produto.

Não ligue vários produtos a uma tomada elétrica danificada ou individual. Utilize apenas tomadas com ligação à terra que cumpram com as normas da indústria. **O desrespeito pelo mencionado anteriormente pode levar ao risco de choques elétricos e incêndio.**



Não dobre ou cause tensões excessivas no cabo de alimentação. Empurre com cuidado o cabo de alimentação totalmente em direção à tomada elétrica para que a ligação seja segura. Certifique-se de que segura o cabo com firmeza ao separá-lo da tomada elétrica. Não remova o cabo de alimentação enquanto estiver a utilizar o produto. **O desrespeito pelo mencionado anteriormente pode levar ao risco de choques elétricos e incêndio.**



Mantenha líquidos em excesso afastados do cabo de alimentação e da tomada. Se os elementos entrarem em contacto com os cabos de alimentação, limpe-os com um pano seco. **O desrespeito pelo mencionado anteriormente pode levar ao risco de choques elétricos e incêndio.**



Se o produto emitir um som estranho, odor a queimado ou fumaça, desligue da corrente imediatamente e retire o cabo de alimentação da tomada. Se o produto tiver odor ou seu exterior estiver danificado, desligue-o da corrente imediatamente e retire o cabo de alimentação da tomada. **Não aqueça o produto e não toque nele. Tal poderá danificar o produto ou originar um incêndio.**



Instale o produto num local estável, de forma a evitar que este caia. Quando mover o produto, desligue-o da corrente e retire todos os cabos ligados, incluindo o cabo de alimentação. **Isto pode danificar o produto.**



Não permita que nenhuma substância estranha entre dentro do produto. Não coloque objetos pesados, líquidos ou metais sobre o produto. **Tal poderá danificar o produto ou originar um incêndio.**



Use apenas produtos originais da BXOLON. **A empresa não irá fornecer serviço pós-venda por danos ou outros problemas resultantes da utilização de produtos de concorrência (ou recondicionados).**



Mantenha acessórios pequenos ou outros materiais de embalagem afastados de crianças pequenas. Cuidado: perigo de asfixia. **O manuseamento incorreto do produto pode causar ferimentos sucessíveis de serem necessários cuidados médicos urgentes.**



Não permita que o produto fique danificado devido a objetos pesados. **O desrespeito pelo mencionado anteriormente pode levar ao risco de choques elétricos e incêndio.**



Instale o produto numa área bem ventilada, mantendo-o a uma certa distância da parede. Instalar o produto em determinados ambientes que são propensos a pó excessivo, humidade e a flutuações de temperatura ou colocar o produto sob uso extremo pode causar danos à impressora. **Um aumento da temperatura interna pode levar a um incêndio. Certifique-se de contactar o local de compra se não tiver certeza sobre a colocação do produto.**



Não desmonte, repare ou altere o produto por iniciativa própria. Ao fazê-lo, irá invalidar a garantia. **Se for necessária uma reparação, contacte o ponto de compra original.**



Se existir um problema com o produto, entre em contacto com o ponto de compra original ou através da página de reparações de produtos do site Web da BXOLON (www.bxolon.com).



OSTRZEŻENIE I PRZESTROGA

Signalizuje niebezpieczeństwo śmierci, obrażeń fizycznych, poważnych strat finansowych, uszkodzenia danych itp. dla użytkownika.

Nie podłączaj wielu urządzeń do jednego gniazdzka zasilania lub do wadliwego gniazdzka zasilania. Należy używać wyłącznie uzemiennych gniazdek elektrycznych spełniających normy branżowe. **Nieprzeżyczenie tego zalecenia może spowodować porażenie prądem elektrycznym lub pożar.**



Nie należy nadmiernie zginąć ani naciskać przewodu zasilającego. Przewód zasilający należy wyciągnąć do końca do gniazdzka, aby nie pozostał luźny. Podczas odłączania przewodu od gniazdzka zasilania należy go mocno trzymać. Nie wolno odłączać przewodu zasilającego podczas używania urządzenia. **Nieprzeżyczenie tego zalecenia może spowodować porażenie prądem elektrycznym lub pożar.**



Nadmiernie ciepły dźwięk należy przechowywać z dala od przewodu zasilającego gniazdzka. W przypadku zabrudzenia przewodów zasilających należy wytrzeć je suchą szmatką. **Nieprzeżyczenie tego zalecenia może spowodować porażenie prądem elektrycznym lub pożar.**



Jeżeli z produktu wydobywa się dziwny dźwięk, zapach spaleniny lub dym, należy natychmiast wyłączyć zasilanie i odłączyć przewód zasilający. W przypadku uszkodzenia urządzenia lub uszkodzenia jego obudowy należy natychmiast wyłączyć zasilanie i odłączyć przewód zasilający. **Nie ruszaj urządzenia nie wstrzymując uszkodzone urządzenie lub pożar.**



Urządzenie należy zainstalować w stałym miejscu, aby zapobiec jego przewróceniu. Podczas przenoszenia urządzenia należy wyłączyć zasilanie i odłączyć wszystkie połączenia do urządzenia, w tym przewód zasilający. **Może to spowodować uszkodzenie urządzenia.**



Nie dopuszczaj do przedostania się ciał obcych do wnętrza urządzenia. Nie umieszczaj na urządzeniu ciężkich przedmiotów, cięższych ani metali. **Mogłyby to spowodować uszkodzenie urządzenia lub pożar.**



Należy używać wyłącznie oryginalnych produktów firmy BXOLON. **Firma nie zapewnia wsparcia posprzedażowego w przypadku uszkodzeń lub innych problemów związanych z jakością, które mogą wystąpić w przypadku podróbionych (lub regenerowanych) produktów.**



Do drobnych akcesoriów lub innych materiałów opakowaniowych należy przechowywać z dala od małych dzieci. Uwaga: ryzyko zadławienia. **Niewłaściwe użyczenie może spowodować obrażenia wymagające pilnej pomocy medycznej.**



Nie dopuścić do uszkodzenia urządzenia przez cięgie przedmioty. **Nieprzeżyczenie tego zalecenia może spowodować porażenie prądem elektrycznym lub pożar.**



Urządzenie należy zainstalować w dobrze wentylowanym miejscu, w pewnej odległości od ściany. Instalacja produktu w środowisku, w którym występuje nadmierne zapylenie, wilgoć i wahania temperatury lub w miejscach, w których występuje uszkodzenie może spowodować uszkodzenie drukarki lub pożar. Wzrost temperatury wewnętrznej może wywołać pożar. **W razie wystąpienia do umieszczenia urządzenia należy skontaktować się z punktem sprzedaży.**



Nigdy nie należy samodzielnie demontować, naprawiać ani modyfikować urządzenia, ponieważ spowoduje to utratę gwarancji. **W razie konieczności naprawy należy skontaktować się z oryginalnym miejscem zakupu.**



W razie wystąpienia problemu z produktem należy skontaktować się z oryginalnym miejscem zakupu lub za pośrednictwem strony napraw produktów w witrynie internetowej firmy BXOLON (www.bxolon.com).



Portuguese

Polish

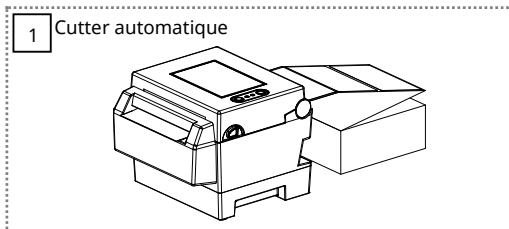
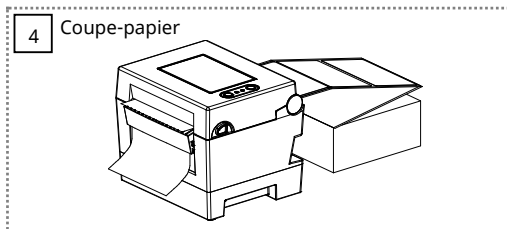
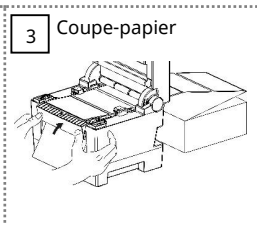
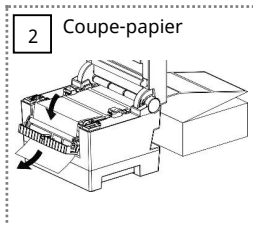
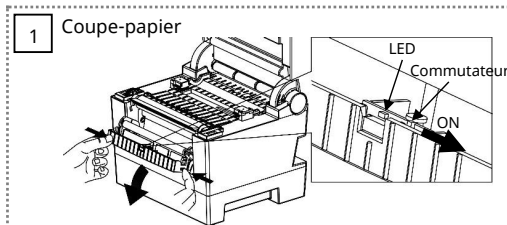
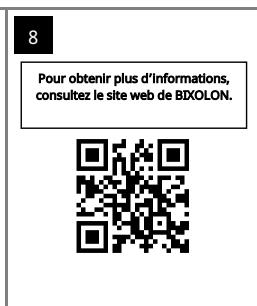
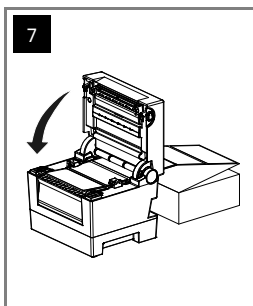
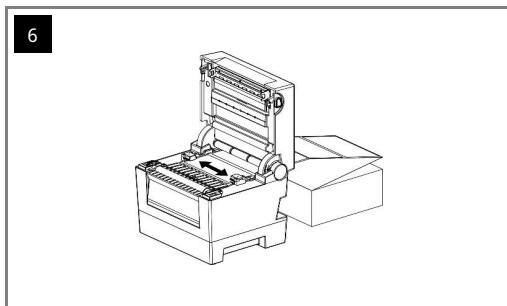
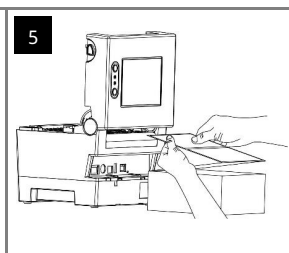
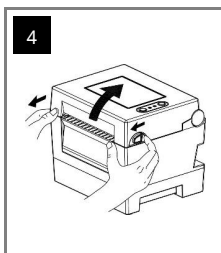
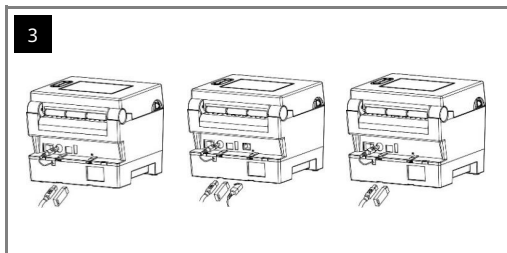
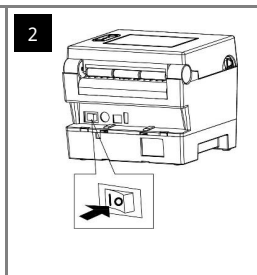
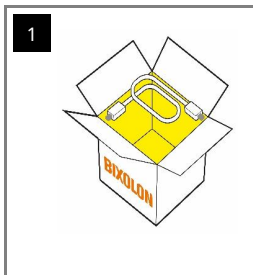
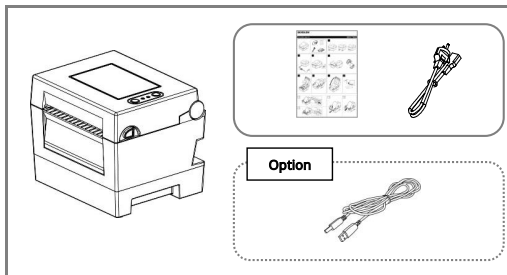

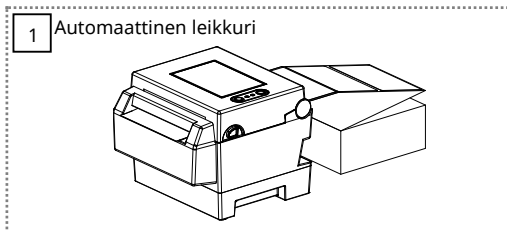
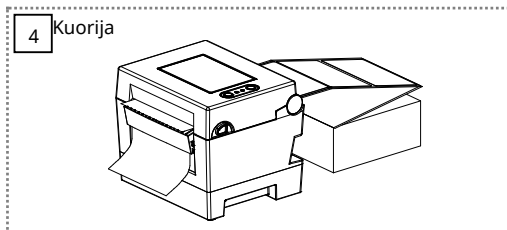
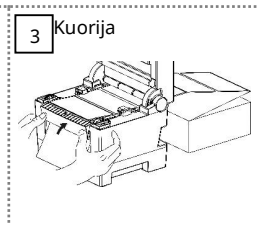
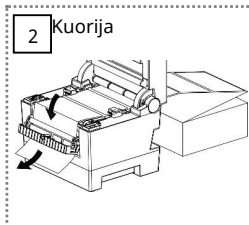
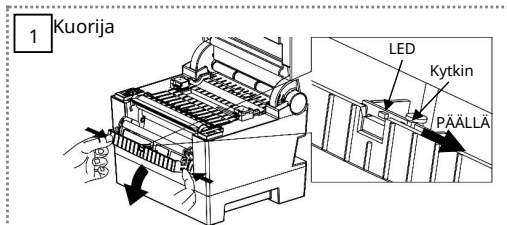
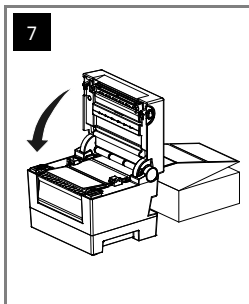
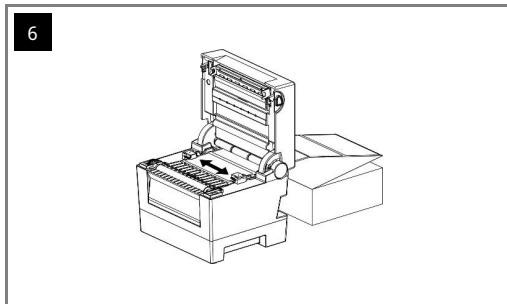
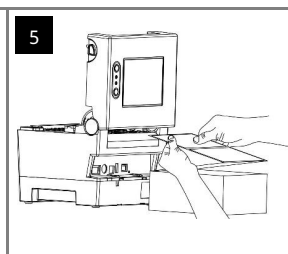
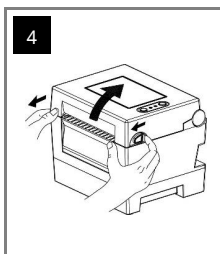
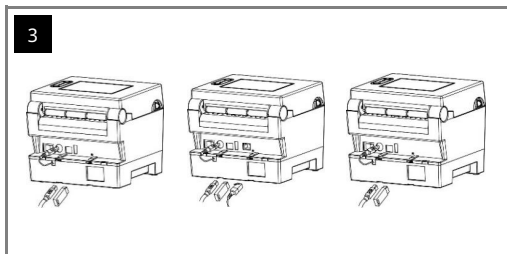
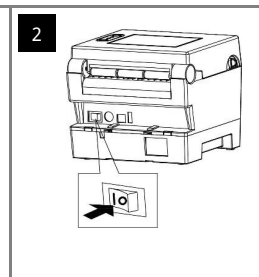
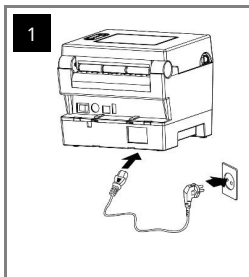
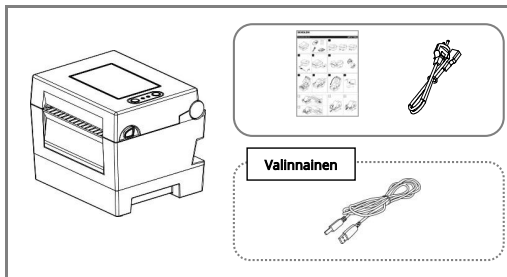



AVERTISSEMENT ET MISE EN GARDE

Cela indique qu'il existe un risque de mort, de blessures corporelles, de pertes financières graves, de dommages aux données, etc. pour l'utilisateur.



VAROITUS JA HUOMIO

Kuavaa kuolemaa, fyysisiä vammoja, vakavia taloudellisia menetyksiä, tietovahinkoja jne., joita käyttäjälle voi aiheutua.

Ne branchez pas plusieurs appareils sur une même prise de courant ou sur une prise défectueuse. N'utilisez que des prises de courant avec mise à la terre conformes aux normes industrielles. **Le non-respect de cette consigne peut causer un choc électrique ou un incendie.**



Utilisez uniquement des produits d'origine BIXOLON. L'entreprise ne fournit pas de service après-vente pour les dommages ou autres problèmes de qualité causés par l'utilisation de produits contrefaits (remis à neuf).



Ne phez pas ou ne tendez pas de manière excessive le cordon d'alimentation. Enfoncez fermement le cordon d'alimentation à fond dans la prise de courant pour éviter qu'il ne se détache. Veillez à bien tenir le cordon lorsque vous le débranchez de la prise de courant. Ne retirez pas le cordon d'alimentation lorsqu'il y a du son ou de l'activité. **Le non-respect de cette consigne peut causer un choc électrique ou un incendie.**



Gardez les petits accessoires ou autres matériaux d'emballage hors de portée des jeunes enfants. Attention : risque d'étouffement. **Une mauvaise manipulation du produit peut entraîner des blessures, qui nécessitent l'intervention urgente d'un médecin.**



Tenez les liquides à l'écart du cordon d'alimentation et de la prise de courant. Si vous devez nettoyer le cordon d'alimentation, utilisez un chiffon sec. **Le non-respect de cette consigne peut causer un choc électrique ou un incendie.**



Veillez à ce que le produit ne soit pas endommagé par des objets lourds. **Le non-respect de cette consigne peut causer un choc électrique ou un incendie.**



Si le produit émet un son étrange, une odeur de brûlé ou de la fumée, éteignez-le immédiatement et débranchez le cordon d'alimentation. Si le produit tombe ou s'il présente des signes de dommages, éteignez-le immédiatement et débranchez le cordon d'alimentation. **Nesourrez pas le produit à chaud. Le non-respect de cette consigne peut causer un choc électrique ou un incendie.**



Installez le produit dans un endroit bien ventilé et le maintenez à une certaine distance du mur. L'installation du produit dans certains environnements sages à la poussière, à l'humidité et aux variations de température excessives ou l'utilisation excessive du produit peuvent endommager l'imprimante. Une augmentation de la température interne peut provoquer un incendie. **Ne laissez pas le feu d'achat et n'ouvrez pas le couvercle de l'imprimante.**



Installez le produit dans un endroit sûr pour éviter qu'il ne bascule. Lorsque vous déplacez le produit, mettez-le hors tension et débranchez tous les câbles connectés. **Le non-respect de cette consigne peut endommager le produit.**



Ne tentez jamais de démonter, réparer ou modifier le produit vous-même, sous peine d'annuler la garantie. **Si une réparation est nécessaire, contactez votre revendeur.**



Ne laissez pas de substances étrangères pénétrer dans le produit. Ne placez pas d'objets lourds, de liquides ou de métaux sur le produit. **Le non-respect de cette consigne peut causer un choc électrique ou un incendie.**



En cas de problème avec le produit, veuillez contacter le lieu d'achat d'origine ou la page de réparation des produits du site web de BIXOLON (www.bixolon.com).



Älä liitä useita tuotteita samaan tai vialleeseen pistorasiaan. Käytä vain alan standardin mukaisia maadotettuja pistorasioita. **Määräysten noudattamatta jättäminen voi aiheuttaa sähköiskun tai tulipalon.**



Käytä vain aitoja BIXOLON-tuotteita. Yritys ei tarjoa myynnin jälkeistä tukea vahingoissa tai muissa laatuongelmissa, joita väärennoille (tai kunnostetuille) tuotteille voi aiheutua.



Älä tavuta tai kiristä virtajohtoa liiaksi. Työnnä virtajohto tarpeeksi kokonaan pistorasiaan, jotta se ei jää löysäksi. Varmista, että pidät lukasta kiinni johdosta, kun irrotat sen pistorasiasta. **Älä irrota virtajohtoa, kun tuote on käynnissä. Käyttäjien noudattamatta jättäminen voi aiheuttaa sähköiskun tai tulipalon.**



Pitä pienet tarvikkeet tai muu pakkauskäyttömateriaali poiska pienten lasten ulottuvilla. Vältä tuikeutumavaara. **Tuotteen värähdellen kädellä voi aiheuttaa vammoja, jotka saattavat vaatia lääketieteellistä lääkärin hoitoa.**



Pitä ylimääräiset nesteet kaukana virtajohdosta ja pistorasiasta. Jos virtajohtoihin on tahrinutunut aineita, pyyhi se pois kuivalla liinalla. **Määräysten noudattamatta jättäminen voi aiheuttaa sähköiskun tai tulipalon.**



Älä anna painavien esineiden vahingoittaa tuotetta. **Määräysten noudattamatta jättäminen voi aiheuttaa sähköiskun tai tulipalon.**



Jos tuotteesta kuuluu outoa ääntä, palavaa hajua tai savua, katkaise virta välittömästi ja irrota virtajohto. Jos tuote putoaa tai sen ulkoiset osat vaurioituvat, katkaise virta välittömästi ja irrota virtajohto. **Älä lähesty tuotetta lämpöä. Tämä voi aiheuttaa vahinkoa tuotteelle tai tulipalon.**



Asema tuote hyvin tuuletettuun tilaan ja pidä se sieyellä etäällä kädeltä. Tuotteen asennuksen testauksen ympäristöihin, jotka ovat alttiita ilmailulle, pölylle, kostuudelle ja lämpötilavaihtelulle, tai tuotteen asennuksen äärimmäisen käytön voi vahingoittaa tuotetta. Säälien lämpötilan nousta voi aiheuttaa tulipalon. **Älä koskaan käytä tuotteita, joita ei ole tarkoitettu tuotteen käyttöön.**

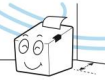

Asema tuote kiinteään pakkaukseen, jotta se ei pääse kaatumaan. Kun siirät tuotetta, katkaise virta ja irrota kaikki liitetyt kaapelit, myös virtajohto. **Koska se voi vahingoittaa tuotetta.**



Älä koskaan pura, korjaa tai muuta tuotetta itsenäisesti, sillä takuu raukeaa. **Jos korjaus on tarpeen, ota yhteyttä alkuperäiseen ostopaikkaan.**



Älä päästä tuotteeseen mitään vieraita aineita. **Älä aseta tuotteen päälle raskaita esineitä, nestettä tai metalleja. Tämä voi aiheuttaa vahinkoa tuotteelle tai tulipalon.**



Jos tuotteessa on ongelma, ota yhteyttä alkuperäiseen ostopaikkaan tai BIXOLONin verkkosivuston tuotekorjaussivun kautta (www.bixolon.com).



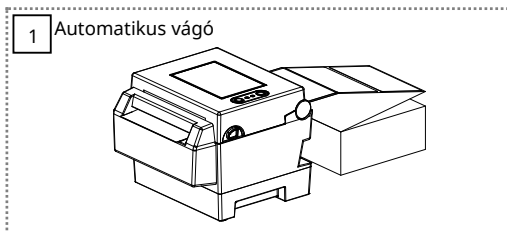
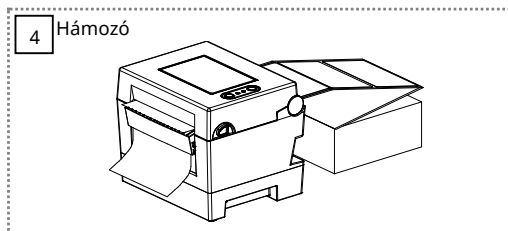
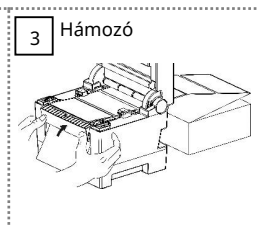
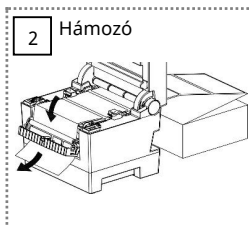
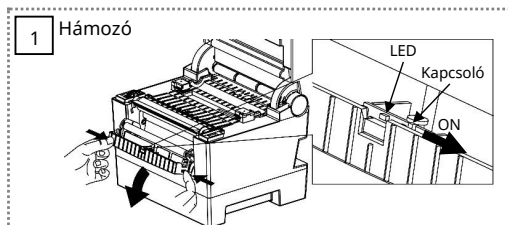
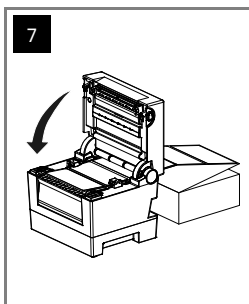
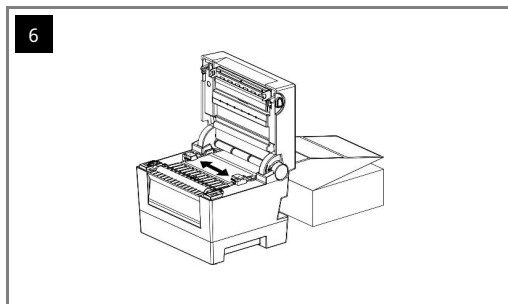
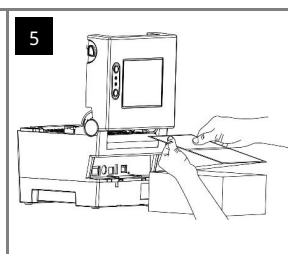
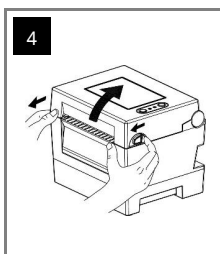
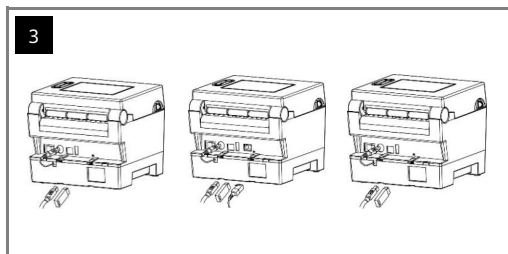
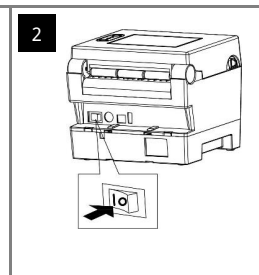
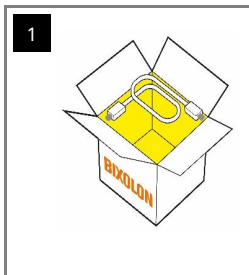
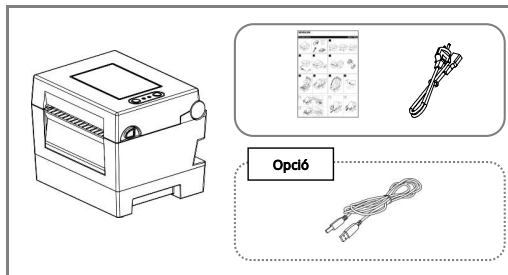



FIGYELMEZTETÉS ÉS VIGYÁZAT

A felhasználónak okozott halál, testi sérülés, súlyos pénzügyi veszteség, adatkárosodás stb.

Ne csatlakoztasson több terméket egyetlen vagy hibás konnektorhoz.
Csak az ipari szabványnak megfelelő konnektort használjon. **A nem megfelelő elektromos csatlakozókat áramütést vagy tüzet okozhat.**



Csak a BIXOLON hiteles termékeit használja. **A vállalat nem nyújt eladás utáni támogatást hamisított (vagy feljuttat) termékek esetén felelőtlenségért vagy egyéb minőségi problémák miatt.**



Ne hajlítsa meg vagy ne feszítse meg túlsótan a tápkábelét. Biztonságosan nyomja be teljesen a tápkábelét a konnektorba, nehogy meglazuljon. Ügyeljen arra, hogy szorosan tartsa a kábelt, amikor kihúzza a konnektorból. Ne húzza ki a tápkábelét, amíg a termék használatban van. **A nem megfelelő elektromos csatlakozókat áramütést vagy tüzet okozhat.**



A kis tartozékokat vagy egyéb csomagolóanyagokat tartsa távol a készülékétől. Vigyázat: fűladdésveszély. **A termék helytelen kezelése olyan sérüléseket okozhat, amelyek sürgős orvosi ellátást igényelhetnek.**



Tartsa távol a túlzott mennyiségű folyadékot a tápkábelétől és a konnektortól. Ha anyag került a tápkábelekre, törölje le száraz ruhával. **A nem megfelelő elektromos csatlakozókat áramütést vagy tüzet okozhat.**

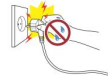

Ne hagyja, hogy a terméket nehéz tárgyak károsítsák. **A nem megfelelő elektromos csatlakozókat áramütést vagy tüzet okozhat.**



Ha a termék furcsa hangot bocsát ki, éppszaga van vagy füstöl, azonnal kapcsolja ki a készüléket, és húzza ki a tápkábelét. Ha a terméket leejti, vagy a külseje megsérül, azonnal kapcsolja ki a készüléket, és húzza ki a tápkábelét. Ne tegye ki a terméket útnak. **Ez a termék károsodást vagy tüzet okozhat.**



Teljesítse a terméket jó csatlakozási helyre, a kábel távol legyen a falától. A termék olyan környezetben kerül beállításra, amelyben túlzott párnak, nedvességnek és hőmérséklet-ingadozásnak lehet kitéve, vagy a termék túlzott igénybevétele a nyomtatási károsodást okozhatja. A belső hőmérséklet emelkedése tüzet okozhat. **Ne bontogassa a termék elhelyezését. Ellenkező esetben a vásárlási helyhez.**



Rögzített helyre telepítse a terméket, hogy megakadályozza a felborulást. A termék mozgatásakor kapcsolja ki a készüléket, és húzza ki az összes csatlakoztatott kábelt, beleértve a tápkábelét is. **Ugyanis ez károsítja a terméket.**



Soha ne szerelje szét, ne javítsa vagy módosítsa a terméket önállóan, mert a jótállás érvényét veszti. **Ha javításra van szükség, forduljon az eredeti vásárlási helyhez.**



Ne engedje, hogy a termékbe idegen anyag kerüljön. Ne helyezzen nehéz tárgyakat, folyadékokat vagy fémekeket a termékre. **Ez a termék károsodást vagy tüzet okozhat.**



Ha a termékkel probléma merül fel, kérjük, forduljon a vásárlási helyhez vagy keresse fel a BIXOLON weboldalának termékjavítási oldalát (www.bixolon.com).



Hungarian