

QNAP

NAS Quick Installation Guide

快速安裝手冊 빠른 설치 설명서 Guía de Instalación Rápida

クイックインストールガイド Hızlı Kurulum Kılavuzu

คู่มือการติดตั้งแบบเร็ว Gyors telepítési útmutató

Instrukcja szybkiej instalacji Průvodce rychlou in

Kurzinstallationsanleitung 快速安裝指南

Guida di installazione

Краткое руководство

Snabbinstallations

Guia de Instalação

Hurtiginstallasjons

Hurtig installations

Pika-asennusopa

Snelle Installatieg

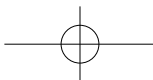
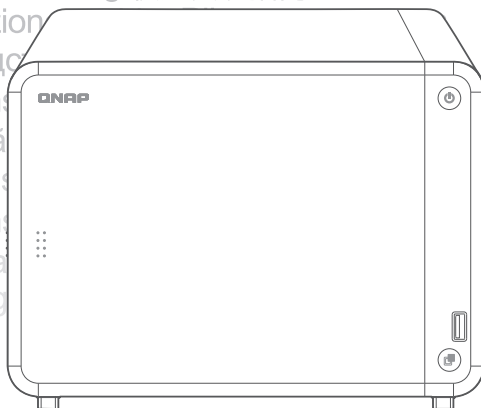

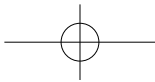
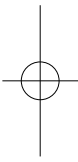
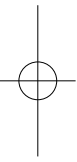
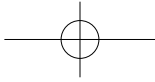

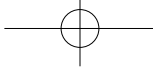

4-bay

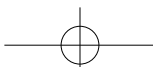
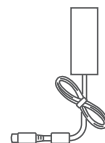
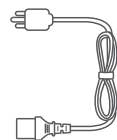
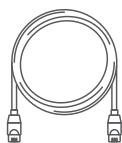

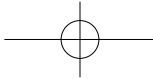

6-bay

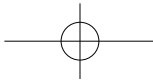
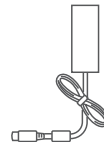
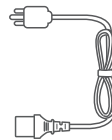
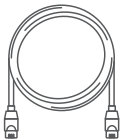
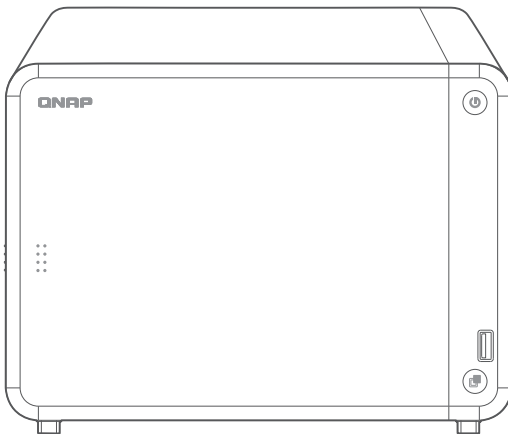

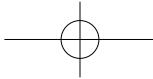

SSD/HDD

<http://www.qnap.com/compatibility>

- EN | All the drive data will be cleared upon SSD / HDD initialization
- DE | Alle Laufwerksdaten werden bei SSD/HDD-Initialisierung gelöscht
- FR | Toutes les données présentes sur les disques seront effacées lors de l'initialisation des SSD/HDD
- IT | Tutti i dati presenti verranno cancellati durante l'inizializza zione degli SSD / HDD
- ES | Todos los datos del disco serán borrados con la inicialización del SSD / HDD
- NL | Alle gegevens worden gewist tijdens de initialisatie van de SSD / HDD's
- SV | All data kommer att raderas när SSD / HDD initieras
- FI | SSD / HDD alustaminen poistaa kaikki tiedostot
- DA | Alle data på drevet vil blive ryddet efter initialisering af SSD / HDD
- NO | All data vil bli slettet når SSD / HDD er initialisert
- PT | Todos os dados do SSD / HDD serão apagados com a inicialização do SSD / HDD
- RU | После инициализации SSD/HDD все данные на нем будут удалены
- ZH | 硬碟初始化時，所有資料皆會被清除
- CN | 所有SSD / HDD上的数据都将会被清除
- JA | SSD/HDDを初期化すると、すべてのデータが消去されます
- KO | SSD / HDD 를 초기화 시키면 드라이브의 모든 데이터가 손실됩니다
- TH | ข้อมูลในไดรฟ์จะถูกลบออก เมื่อมีการตั้งค่าเริ่มต้น
- TR | Kurulum başladığında SSD / HDD disk üzerinde ki tüm veri siline cektir
- HU | Minden korábbi adat törlődik az SSD / HDD-ről az első rendszeri ndítás során
- CS | Všechna data na SSD / HDD budou smazána v důsledku inicializace
- PL | Podczas instalacji wszystkie dane na dyskach SSD / HDD zostaną usunięte
- AR | قئی به دن ع صراق اأا كرحم ثانایب لك جسم م تى HDD(قبالصا ءالجال صرق)SSD(قبالصا صراق اأا كرحم)

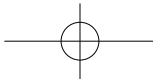
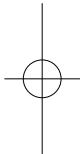
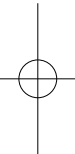

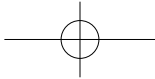

01

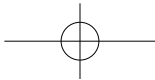
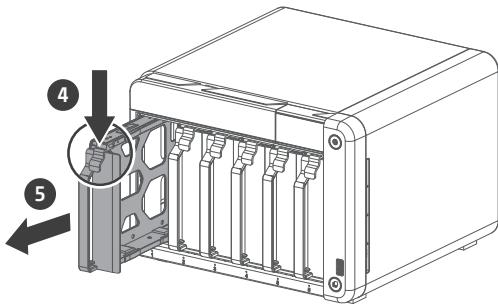
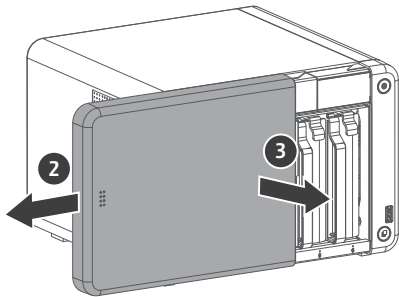
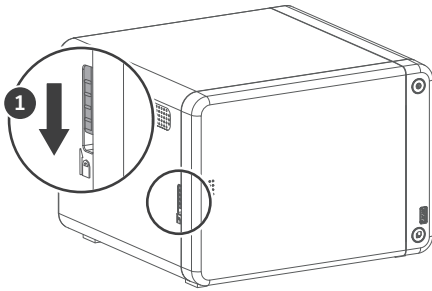

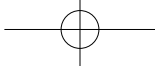

3.5-inch SATA HDD

02

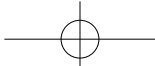
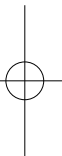
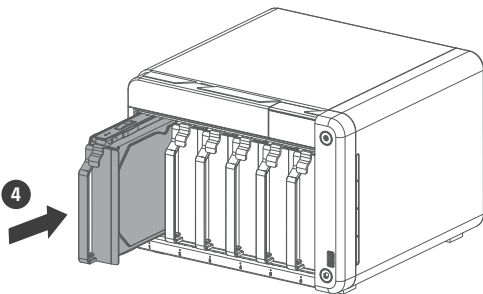
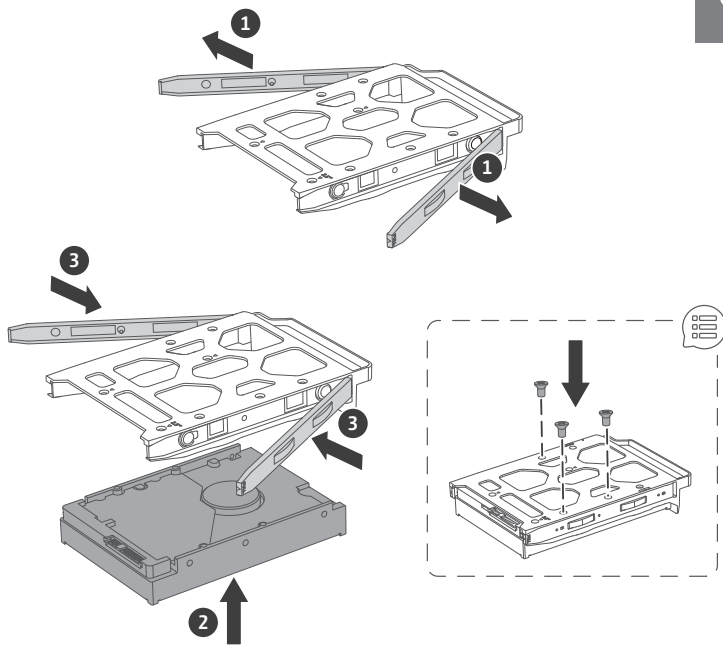

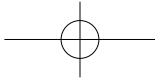

03

2.5-inch SATA SSD

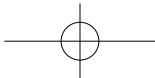
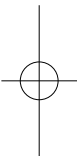
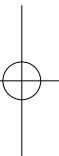
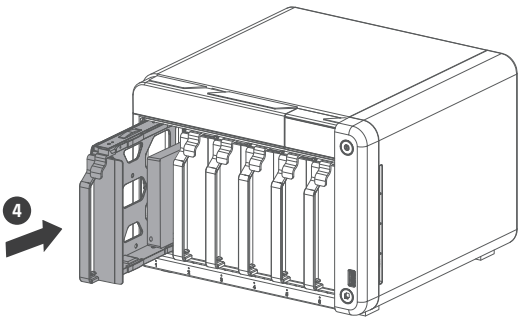
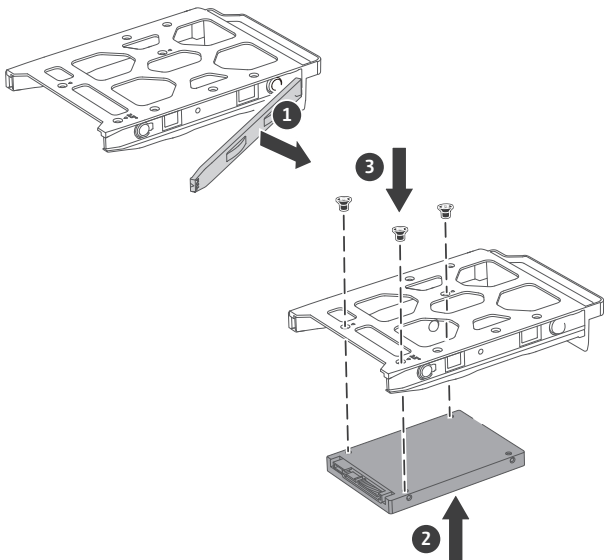

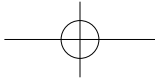

04

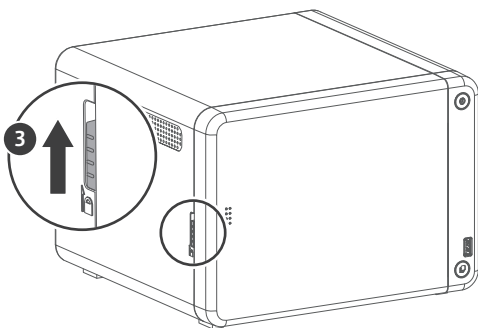
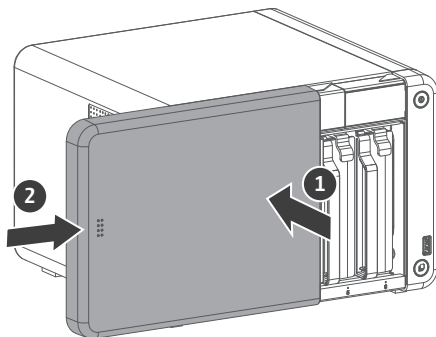

05

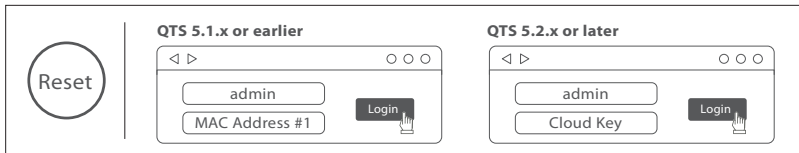
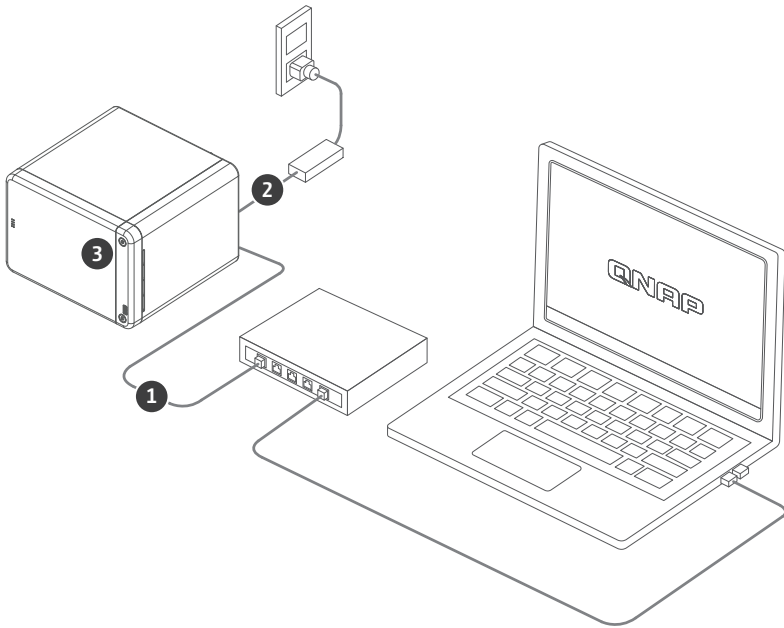
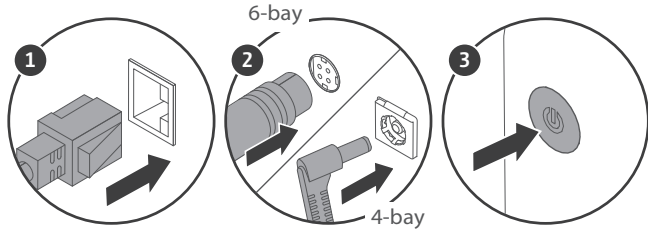

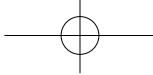

Qfinder Pro



Windows



Mac



Linux

<http://www.qnap.com/qfinderpro>

a



Cloud Installation

<https://install.qnap.com/>

b

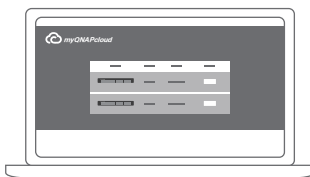

c

Scan the QR code

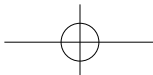
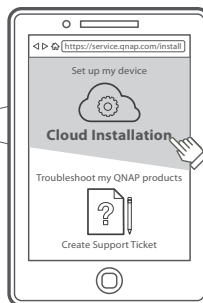
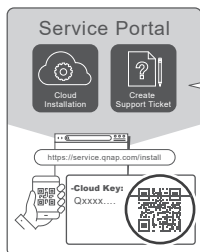

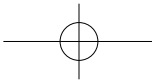

Download Center
www.qnap.com/download

- EN** | Visit Download Center for our full guides and utilities.
- DE** | Unsere vollständigen Handbücher und Dienstprogramme finden Sie im Download Center.
- FR** | Visitez le Centre de téléchargement pour accéder à nos guides et utilitaires complets.
- IT** | Per le guide e le utilità complete, visitare il Centro download.
- ES** | Visite el Centro de descargas para ver todas nuestras guías y utilidades.
- NL** | Bezoek het downloadcentrum voor onze uitgebreide gidsen en hulprogramma's.
- SV** | Besök Nedladdningscenter för våra fullständiga guider och verktyg.
- FI** | Katso täydelliset oppaat ja apuohjelmat latauskeskuksestamme.
- DA** | Besøg Downloadcenter for at se alle vores vejledninger og hjælpeværktøjer.
- NO** | Gå til Nedlastingscenter for fullstendige veiledninger og verktøy.
- PT** | Visite a Central de Download para acessar nossos guias e utilitários completos.
- RU** | Чтобы ознакомиться с полным набором руководств и служебных программ, посетите Центр загрузки. ru
- ZH** | 請前往下載中心取得完整指南和應用工具
- CN** | 有关完整指南和实用工具，请访问“下载中心”
- JA** | 完全なガイドとユーティリティについては、ダウンロードセンターをご覧ください
- KO** | 다운로드 센터에서 전체 지침 및 유틸리티를 확인하십시오.
- TH** | กรุณาเข้าศูนย์การดาวน์โหลดเพื่อดาวน์โหลดคู่มือฉบับสมบูรณ์และโปรแกรมอรรถประโยชน์ต่างๆ
- TR** | Tam kılavuzumuz ve yardımcı hizmetlerimiz için İndirme Merkezini ziyaret edin.
- HU** | A teljes útmutatók és segédprogramok megtekintéséhez keresse fel a Letöltési központot.
- CS** | Kompletního průvodce a nástroje najdete na webu Centrum stahování.
- PL** | Odwiedź Centrum pobierania, aby uzyskać kompletne przewodniki i narzędzia.
- AR** | يرجى زيارة مركز برامجي لضفت تاودأال او ولدأال ى لى لوصم لل ل لم الال ةوع اسم ل

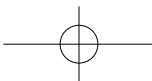
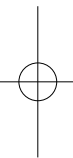

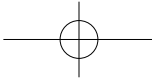

This device complies with Part 15 of the FCC Rules. Operation is subject to the following two conditions:

1. This device may not cause harmful interference.
2. This device must accept any interference received, including interference that may cause undesired operation.

FCC Class B Notice:

This equipment has been tested and found to comply with the limits for a Class B digital device, pursuant to Part 15 of the FCC Rules. These limits are designed to provide reasonable protection against harmful interference in a residential installation. This equipment generates, uses, and can radiate radio frequency energy and, if not installed and used in accordance with the instructions, may cause harmful interference to radio communications. However, there is no guarantee that interference will not occur in a particular installation. If this equipment does cause harmful interference to radio or television reception, which can be determined by turning the equipment off and on, the user is encouraged to try to correct the interference by one or more of the following measures:

- Reorient or relocate the receiving antenna.
- Increase the separation between the equipment and receiver.
- Connect the equipment into an outlet on a circuit different from that to which the receiver is connected.
- Consult the dealer or an experienced radio/television technician for help.

Modifications:

Any modifications made to this device that are not approved by QNAP Systems, Inc. may void the authority granted to the user by the FCC to operate this equipment.



This device complies with CE compliance Class B.



According to the requirement of the WEEE legislation the following user information is provided to customers for all branded QNAP products subject to the WEEE directive.

This symbol on the product or on its packaging indicates that this product must not be disposed of with your other household waste. Instead, it is your responsibility to dispose of your waste equipment by handing it over to a designated collection point for the recycling of waste electrical and electronic equipment. The separate collection and recycling of your waste equipment at the time of disposal will help to conserve natural resources and ensure that it is recycled in a manner that protects human health and the environment. For more information about where you can drop off your waste equipment for recycling, please contact your local city office, your household waste disposal service or the shop where you purchased the product.



Office in EU;
QNAP GmbH,
Karl-Arnold-Straße 26,
47877 Willich, Germany

Office in UK;
QNAP Ltd,
2 Drakes Meadow, Swindon SN3 3LL
United Kingdom

This device complies with the UKCA requirements for products sold in Great Britain.



更多關於安全、法規、與環境法令遵循相關的資訊，請參閱以下網址 www.qnap.com/regulatory/。



| Operation of this equipment in a residential environment could cause radio interference.

| 付属の電源コードは当該製品専用です。他の機器に使用しないでください。

| 斷接裝置：器具耦合器应当便於操作，附近不得被其他物體遮擋；
注意：用錯誤型號電池更換會有爆炸危險，務必按照說明處置用完的電池。

| CAN ICES-003(A) / NMB-003(A)

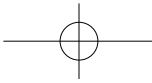

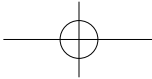

- **Battery type: CR2032 / Nominal voltage: 3.0 Volts**

⚠ WARNING	
<ul style="list-style-type: none">• INGESTION HAZARD: This product contains a button cell or coin battery.• DEATH or serious injury can occur if ingested.• A swallowed button cell or coin battery can cause Internal Chemical Burns in as little as 2 hours.• KEEP new and used batteries OUT OF REACH of CHILDREN• Seek immediate medical attention if a battery is suspected to be swallowed or inserted inside any part of the body.	

1. Battery type: CR2032.

2. Nominal battery voltage: 3.0 volts.

- Remove and immediately recycle or dispose of used batteries according to local regulations and keep away from children. Do NOT dispose of batteries in household trash or incinerate.
- Even used batteries may cause severe injury or death.
- Call a local poison control center for treatment information.
- Non-rechargeable batteries are not to be recharged.
- Do not force discharge, recharge, disassemble, heat above (manufacturer's specified temperature rating) or incinerate. Doing so may result in injury due to venting, leakage or explosion resulting in chemical burns.
- Ensure the batteries are installed correctly according to polarity (+ and -).
- Do not mix old and new batteries, different brands or types of batteries, such as alkaline, carbon-zinc, or rechargeable batteries.
- Remove and immediately recycle or dispose of batteries from equipment not used for an extended period of time according to local regulations.
- Always completely secure the battery compartment. If the battery compartment does not close securely, stop using the product, remove the batteries, and keep them away from children.

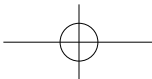
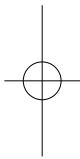
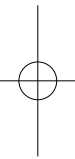

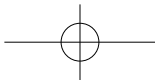
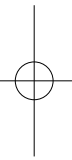
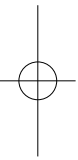
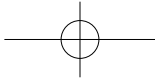

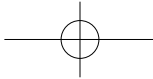

install.qnap.com



service.qnap.com



download.qnap.com

QNAP[®]



51000-025299-HF