

MC9400/MC9450

Mobile Computer



ZEBRA

Product Reference Guide

2023/11/21

ZEBRA and the stylized Zebra head are trademarks of Zebra Technologies Corporation, registered in many jurisdictions worldwide. All other trademarks are the property of their respective owners. ©2023 Zebra Technologies Corporation and/or its affiliates. All rights reserved.

Information in this document is subject to change without notice. The software described in this document is furnished under a license agreement or nondisclosure agreement. The software may be used or copied only in accordance with the terms of those agreements.

For further information regarding legal and proprietary statements, please go to:

SOFTWARE: zebra.com/linkoslegal.

COPYRIGHTS: zebra.com/copyright.

PATENTS: ip.zebra.com.

WARRANTY: zebra.com/warranty.

END USER LICENSE AGREEMENT: zebra.com/eula.

Terms of Use

Proprietary Statement

This manual contains proprietary information of Zebra Technologies Corporation and its subsidiaries ("Zebra Technologies"). It is intended solely for the information and use of parties operating and maintaining the equipment described herein. Such proprietary information may not be used, reproduced, or disclosed to any other parties for any other purpose without the express, written permission of Zebra Technologies.

Product Improvements

Continuous improvement of products is a policy of Zebra Technologies. All specifications and designs are subject to change without notice.

Liability Disclaimer

Zebra Technologies takes steps to ensure that its published Engineering specifications and manuals are correct; however, errors do occur. Zebra Technologies reserves the right to correct any such errors and disclaims liability resulting therefrom.

Limitation of Liability

In no event shall Zebra Technologies or anyone else involved in the creation, production, or delivery of the accompanying product (including hardware and software) be liable for any damages whatsoever (including, without limitation, consequential damages including loss of business profits, business interruption, or loss of business information) arising out of the use of, the results of use of, or inability to use such product, even if Zebra Technologies has been advised of the possibility of such damages. Some jurisdictions do not allow the exclusion or limitation of incidental or consequential damages, so the above limitation or exclusion may not apply to you.

Contents

Getting Started.....	11
Unpacking the Device.....	11
Device Features.....	12
Setting Up the Device.....	13
Installing a microSD Card.....	14
Installing a SIM Card.....	17
Installing the Battery.....	21
Replacing the Battery.....	22
Charging the Device.....	24
Using the Device.....	27
Waking the Device.....	27
Home Screen.....	27
Status Bar.....	28
Special Keys.....	32
Managing Notifications.....	33
Opening the Quick Access Panel.....	34
Battery Management.....	37
Checking Battery Status.....	38
Low Battery Notification.....	38
Monitoring Battery Usage.....	38
Monitoring App Battery Usage.....	38
USB Communication.....	39
Transferring Files.....	39
Transferring Photos.....	39

Disconnecting from the Host Computer.....	40
Interactive Sensor Technology.....	40
Settings.....	41
Accessing Settings.....	41
Display Settings.....	41
Setting the Screen Brightness Manually.....	41
Setting the Screen Brightness Automatically.....	41
Setting Night Light.....	42
Setting the Screen Timeout Value.....	42
Setting Screen Rotation.....	42
Setting Font Size.....	43
Setting Display Size.....	43
Setting the Lock Screen Notifications.....	43
Setting the Touch Panel Mode.....	43
Setting Keyboard Backlight.....	44
Setting the Date and Time.....	44
General Sound Setting.....	45
Sound Options.....	45
Setting Wake-Up Sources.....	46
Remapping a Button.....	46
Keyboards.....	47
Keyboard Configuration.....	47
Using the Android and Gboard Keyboards.....	47
Enterprise Keyboard.....	48
Language Usage.....	49
Changing the Language Setting.....	49
Adding Words to the Dictionary.....	49
Notifications.....	49
Enabling Blink Light.....	50
Applications.....	51
Installed Applications.....	51

Accessing Apps.....	52
Switching Between Recent Apps.....	52
Battery Manager.....	53
Opening Battery Manager.....	53
Battery Manager Information.....	53
Heater Control.....	55
Camera.....	56
Taking Photos.....	57
Recording Videos.....	58
Quick Camera Photo Mode and Video Mode Settings.....	62
Camera and Video Settings.....	63
DataWedge Demonstration.....	64
DataWedge Demonstration Icons.....	64
PTT Express Voice Client.....	65
PTT Express User Interface.....	66
PTT Audible Indicators.....	66
PTT Notification Icons.....	67
Enabling PTT Communication.....	67
Selecting a Talk Group.....	67
PTT Communication.....	67
Disabling PTT Communication.....	68
RxLogger.....	68
RxLogger Configuration.....	68
Configuration File.....	69
Enabling Logging.....	69
Disabling Logging.....	69
Extracting Log Files.....	69
Backing Up Data.....	70
RxLogger Utility.....	70
Data Capture.....	72
Imaging.....	72
Operational Modes.....	73
Scanning Considerations.....	73

Scanning with the Internal Imager.....	74
Pairing a Bluetooth Ring Scanner.....	75
Pairing in SSI Mode Using Near Field Communication.....	76
Pairing in HID Mode Using Near Field Communication.....	76
Pairing Using Simple Serial Interface (SSI).....	77
Pairing Using Bluetooth Human Interface Device.....	77
Pairing a Bluetooth Scanner.....	78
Pairing Using Simple Serial Interface.....	78
Pairing Using Bluetooth Human Interface Device.....	79
DataWedge.....	79
Enabling DataWedge.....	80
Disabling DataWedge.....	80
Supported Decoders.....	80
Camera Supported Decoders.....	80
SE4770 Internal Imager Supported Decoders.....	81
SE58 Internal Imager Supported Decoders.....	82
LI3678 Supported Decoders.....	82
DS2278 Supported Decoders.....	83
DS3678 Supported Decoders.....	84
DS8178 Supported Decoders.....	85
RS507/RS507x Supported Decoders.....	86
RS5100 Supported Decoders.....	86
RS6000 Supported Decoders.....	87
RS6100 Supported Decoders.....	88
Wireless.....	90
Wireless Local Area Networks.....	90
Connecting to a Wi-Fi Network.....	91
Removing a Wi-Fi Network.....	91
WLAN Configuration.....	91
Wireless Wide Area Networks.....	96
Sharing the Mobile Data Connection.....	97
Data Usage.....	98
Cellular Network Settings.....	99

Bluetooth.....100

- Adaptive Frequency Hopping.....100
- Security..... 101
- Bluetooth Profiles..... 101
- Bluetooth Power States.....102
- Bluetooth Radio Power.....102
- Discovering Bluetooth Device(s)..... 103
- Changing the Bluetooth Name.....103
- Connecting to a Bluetooth Device.....103
- Selecting Profiles on the Bluetooth Device..... 104
- Unpairing a Bluetooth Device.....104

Near Field Communications..... 104

- Reading NFC Cards.....105
- Sharing Information Using NFC.....105
- Enterprise NFC Settings..... 106

Cast.....106

Accessories..... 107

Accessories for Charging..... 111

- 1-Slot USB Charge Cradle with Spare Battery Charger..... 111
- 4-Slot Charge Only ShareCradle.....115
- 4-Slot Ethernet ShareCradle..... 117
- 4-Slot Spare Battery Charger.....123
- 16-Slot Spare Battery Charger.....126
- USB Charge/Com Snap-on Cup.....128
- Charge Only Adapter.....133

Attaching the Rubber Boot.....136

Installing the Hand Strap.....138

Fabric Holster..... 139

- Using the Belt Strap..... 139
- Using the Shoulder Strap.....140

Installing the Unpowered Forklift Mount.....142

Wall Installation.....143

- Assembling the 4-Slot Charge Only ShareCradle Rack.....144

Mounting a Single Bracket to a Wall.....	147
Installing the Cradles in a Rack Mount.....	149
Application Deployment.....	154
Security.....	154
Secure Certificates.....	154
Installing a Secure Certificate.....	154
Configuring Credential Storage Settings.....	155
Android Development Tools.....	155
Android Development Workstation.....	155
Enabling Developer Options.....	155
EMDK for Android.....	156
StageNow for Android.....	156
GMS Restricted.....	156
ADB USB Setup.....	157
Enabling USB Debugging.....	157
Entering Android System Recovery Mode Manually.....	158
Application Installation Methods.....	158
Installing Applications Using the USB Connection.....	158
Installing Applications Using the Android Debug Bridge.....	159
Installing Applications Using Wireless ADB.....	159
Installing Applications from a microSD Card.....	161
Uninstalling an Application.....	162
Android System Update.....	162
Performing a System Update Using a microSD Card.....	162
Performing a System Update Using ADB.....	163
Verifying System Update Installation.....	164
Android Enterprise Reset.....	164
Performing an Enterprise Reset From Device Settings.....	164
Performing an Enterprise Reset Using a microSD Card.....	164
Performing an Enterprise Reset Using ADB.....	165
Android Factory Reset.....	165
Performing a Factory Reset Using a microSD Card.....	166
Performing a Factory Reset Using ADB.....	166

Android Storage.....	167
Random Access Memory.....	167
Viewing Memory.....	167
Internal Storage.....	168
External Storage.....	168
Managing Apps.....	169
App Details.....	169
Managing Downloads.....	170
Keypads.....	171
Removing and Replacing Keypads.....	171
58-Keys Alpha Numeric Function Keypad.....	173
53-Keys Standard Keypad.....	177
53-Keys IBM-5250 Emulator Keypad.....	180
53-Keys VT Emulator Keypad.....	183
43-Keys Shifted Alpha Keypad.....	186
34-Keys Numeric Keypad.....	189
29-Keys Shifted Alpha Keypad.....	193
Keypad Special Functions.....	196
Special Characters.....	197
Maintenance and Troubleshooting.....	200
Maintaining the Device.....	200
Battery Safety Guidelines.....	201
Cleaning Instructions.....	201
Approved Cleanser Active Ingredients.....	202
Harmful Ingredients.....	202
Device Cleaning Instructions.....	202
Special Cleaning Notes.....	202
Cleaning Materials Required.....	203
Cleaning Frequency.....	203
Cleaning the Device.....	203
Housing.....	203

Display.....	203
Camera and Exit Window.....	203
Cleaning Battery Connectors.....	203
Cleaning Cradle Connectors.....	204
Troubleshooting.....	204
Resetting the Device.....	204
Troubleshooting the Device.....	205
1-Slot USB Charging Cradle Troubleshooting.....	208
4-Slot Charge Only Cradle Troubleshooting.....	208
4-Slot Ethernet Cradle Troubleshooting.....	209
4-Slot Spare Battery Charger Troubleshooting.....	210
16-Slot Spare Battery Charger Troubleshooting.....	211
Service Information.....	211
Determining Software Versions.....	212
Determining the Serial Number.....	212
Reading the Manufacturing Label.....	212
Specifications.....	214
Configurations.....	214
SE4770-SR Decode Zones.....	217
SE58-ER Decode Zones.....	218
Accessory Specifications.....	219
1-Slot USB Charge Cradle with Spare Battery Charger Technical Specifications.....	219
4-Slot Charge Only ShareCradle Technical Specifications.....	219
4-Slot Ethernet ShareCradle Technical Specifications.....	220
4-Slot Spare Battery Charger Technical Specifications.....	221
16-Slot Spare Battery Charger Technical Specifications.....	221
USB Charge/Com Snap-on Cup Technical Specifications.....	222

Getting Started

This section provides information to get the device up and running for the first time.

Unpacking the Device

Follow these steps when unpacking the device for the first time.

1. Carefully remove all protective material from the device and save the shipping container for later storage and shipping.
2. Verify that the following items are in the box:
 - Mobile computer
 - PowerPrecision+ Lithium-ion battery
 - Regulatory Guide
3. Inspect the equipment for damage. If any equipment is missing or damaged, contact the Global Customer Support Center immediately.
4. Before using the device for the first time, remove the protective shipping films that cover the scan window, display, and camera window.

Device Features

This section lists the features of this mobile computer.

Figure 1 Top View

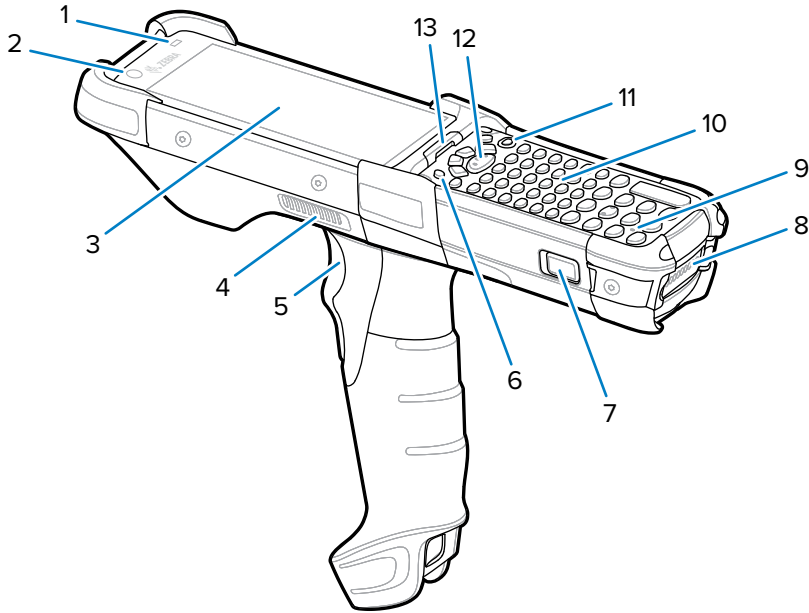

Number	Item	Description
1	Ambient light sensor	Controls display and keyboard backlight.
2	8 MP front-facing camera	Use to take photos and videos.
3	Display	Displays all information needed to operate the device.
4	Speaker side port	Provides audio output for video and music playback.
5	Trigger	Initiates data capture when a scan application is enabled.
6	P1 - dedicated PTT key	Initiates push-to-talk communications (programmable).
7	Battery release latch	Releases the battery from the device. To release the battery, simultaneously press the battery release latches on both sides of the device.
8	Battery	Provides power for operating the device.
9	Microphone	Use for communications in Handset mode.
10	Keypad	Use to enter data and navigate on-screen functions.
11	Power button	Press and hold to turn on the device. Press to turn on or off the screen. Press and hold to select one of these options: <ul style="list-style-type: none"> Power off - Turn off the device. Restart - Restart the device when the software stops responding.
12	Center scan button	Initiates data capture when a scan application is enabled.

Number	Item	Description
13	Charging/notification LED	Indicates the battery charging status while charging, app-generated notifications, and data capture status.

Figure 2 Bottom View

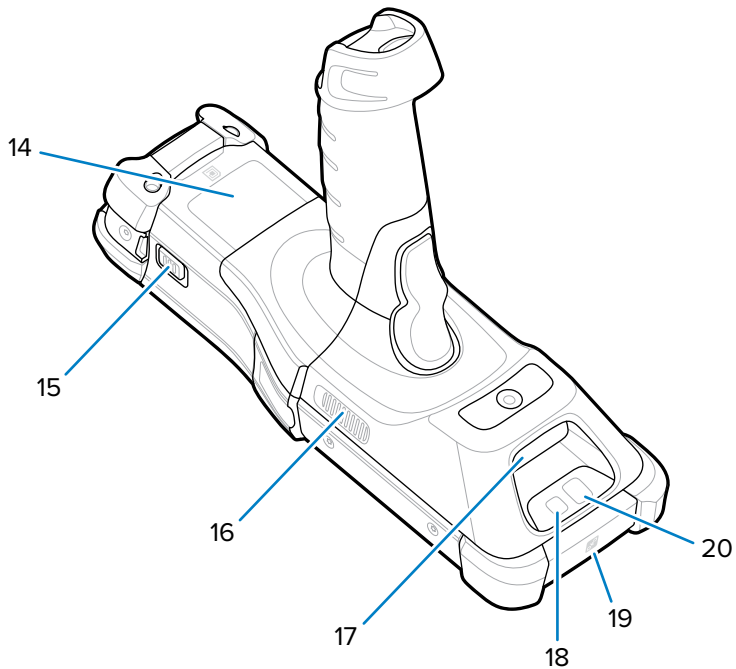

Number	Item	Description
14	Passive NFC tag (Inside the battery compartment.)	Provides secondary product label information (configuration, serial number, and manufacture data code) in the event that the readable product label is worn or missing.
15	Battery release latch	Releases the battery from the device. To release the battery, simultaneously press the battery release latches on both sides of the device.
16	Side speaker port	Provides audio output for video and music playback.
17	Scanner exit window	Provides data capture using the scanner/imager.
18	Camera flash	Provides illumination for the camera.
19	NFC antenna	Provides communication with other NFC-enabled devices.
20	16 MP rear camera	Takes photos and videos.



NOTE: The front camera, rear camera, camera flash, and NFC antenna are available only on premium configurations.

Setting Up the Device

To start using the device for the first time, you must set it up.

1. Install a nano SIM card (optional).

2. Install a microSD card (optional)
3. Install the battery
4. Charge the device
5. Power on the device.

Installing a microSD Card

The microSD card slot provides secondary non-volatile storage. The slot is located under the keypad module. For more information, refer to the documentation provided with the card, and follow the manufacturer's recommendations for use. It is strongly recommended that, prior to use, you format the microSD card on the device.



CAUTION: Follow proper electrostatic discharge (ESD) precautions to avoid damaging the microSD card. Proper ESD precautions include, but are not limited to, working on an ESD mat and ensuring that the operator is properly grounded.

1. Power off the device.
2. Remove the battery
3. Using a long, thin  T8 screwdriver, remove the two screws and washers from inside the battery slot.

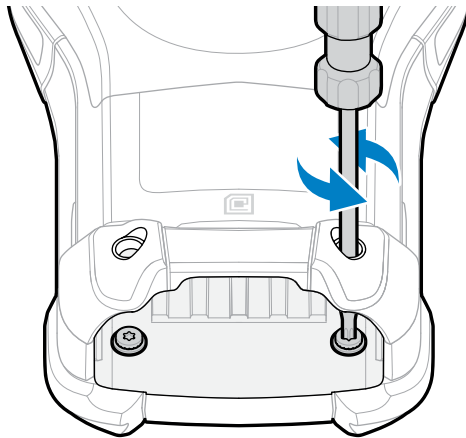

4. Turn the device over so that the keypad is visible.

- Using a  T8 screwdriver, remove the two keypad assembly screws from the top of the keypad.

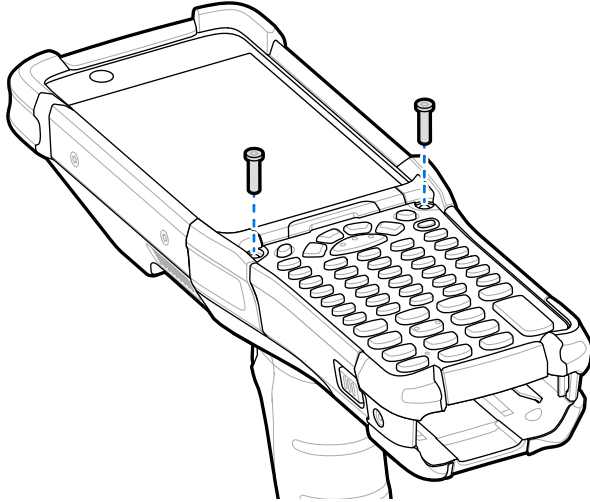

- Lift the keypad from the device to expose the microSD card holder.
- Slide the microSD card holder to the Open position.

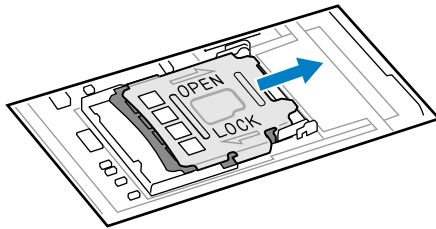

- Raise the microSD card holder.

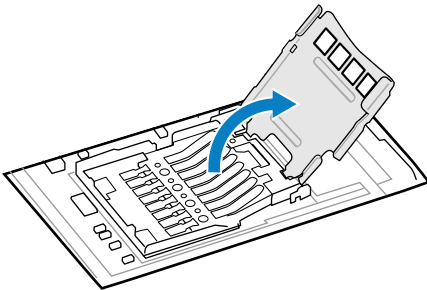

9. Insert the microSD card into the card holder, ensuring that the card slides into the holding tabs on each side.

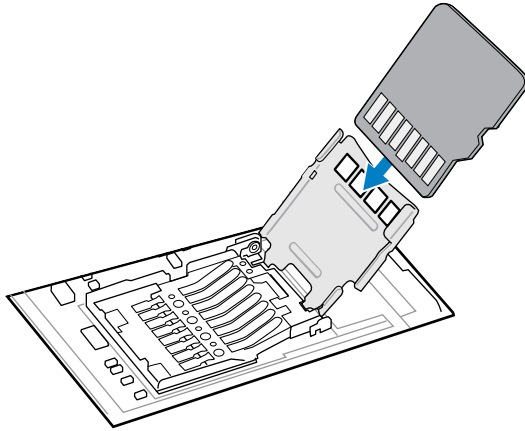

10. Close the microSD card holder and slide it to the Lock position.

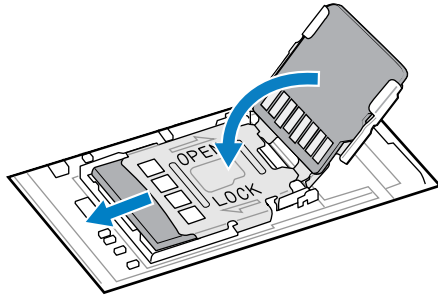

11. Align the keypad along the bottom ridge of the device, and then lay it flat.

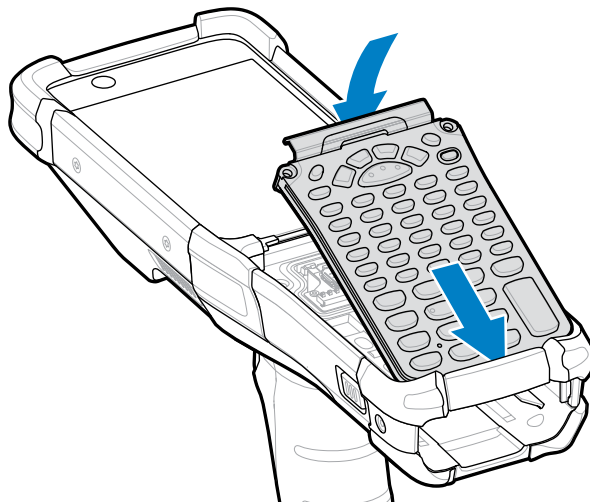

- Using a  T8 screwdriver, secure the keypad to the device using the two screws. Torque screws to 5.8 kgf-cm (5.0 lbf-in).

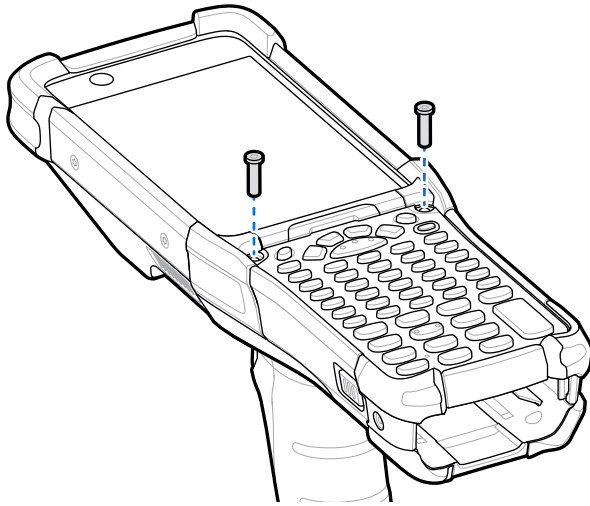

- Turn the device over.
- Using a long, thin  T8 screwdriver, replace the two screws and washers inside the battery slot and torque to 5.8 kgf-cm (5.0 lbf-in).

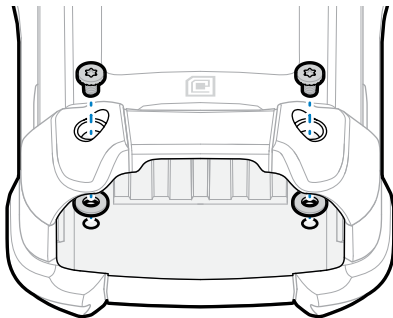

- Insert the battery.
- Press and hold **Power** to power on the device.

Installing a SIM Card

A SIM card holds your network subscriber identity, which allows you to connect to your cellular network. Contact your cellular network provider for information.



CAUTION: Follow proper electrostatic discharge (ESD) precautions to avoid damaging the microSD card. Proper ESD precautions include, but are not limited to, working on an ESD mat and ensuring that the operator is properly grounded.

- Power off the device.
- Remove the battery

3. Using a long, thin  T8 screwdriver, remove the two screws and washers from inside the battery slot.

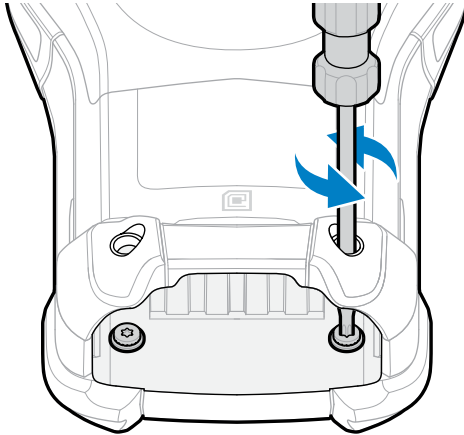

4. Turn the device over so that the keypad is visible.
5. Using a  T8 screwdriver, remove the two keypad assembly screws from the top of the keypad.

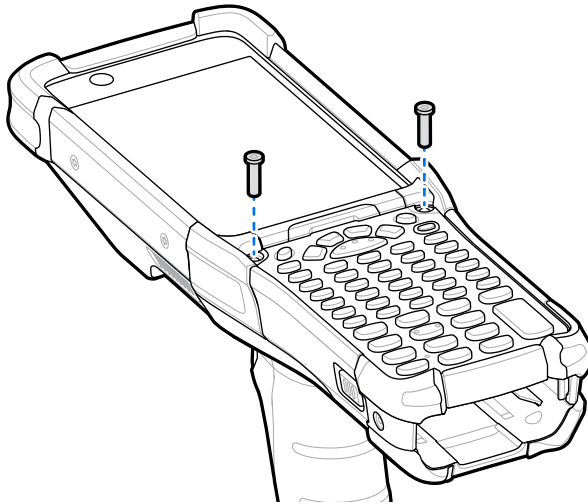

6. Lift the keypad from the device to expose the SIM card holder.
7. Slide the SIM card holder door to the unlock position.

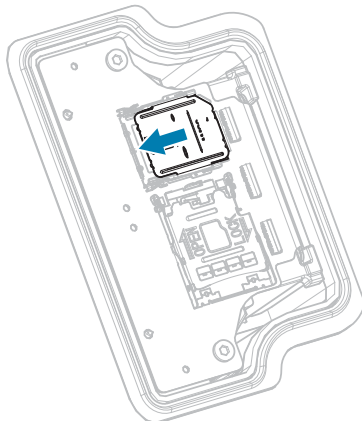

8. Lift the SIM card holder door.

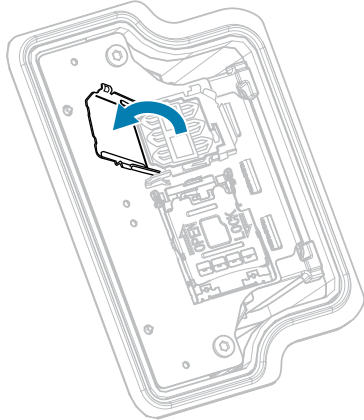

9. Place the SIM card into the card holder with contacts facing down.

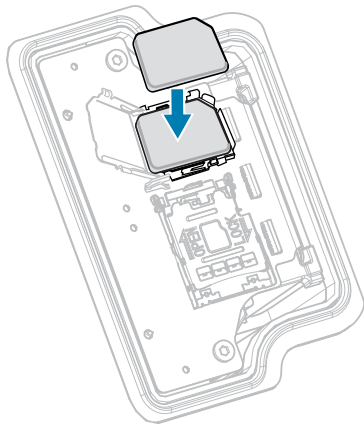

10. Close the SIM card holder door.

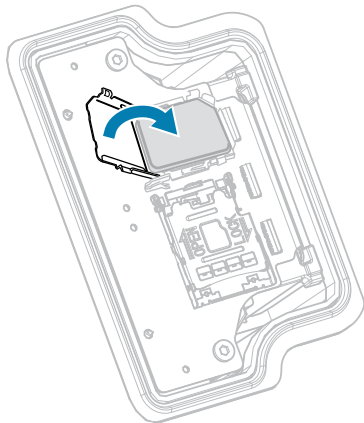

11. Slide the SIM card holder door to the lock position.

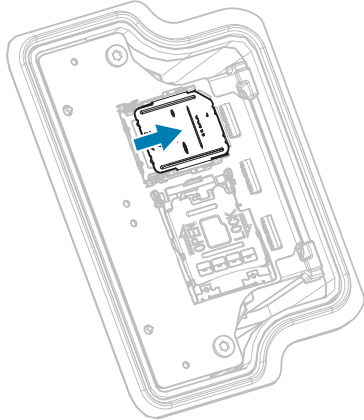

12. Align the keypad along the bottom ridge of the device, and then lay it flat.

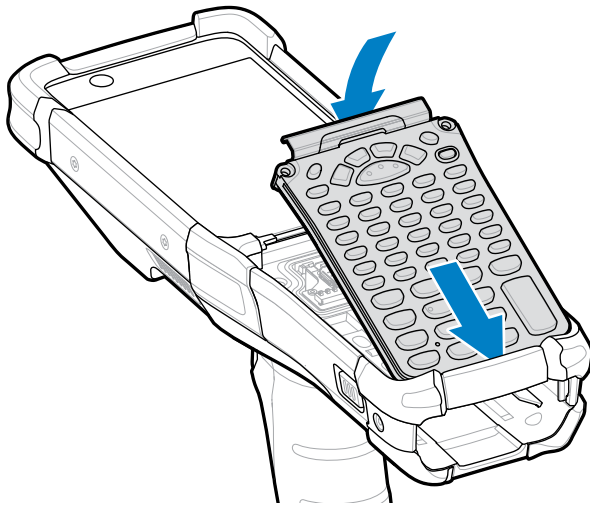

13. Using a  T8 screwdriver, secure the keypad to the device using the two screws. Torque screws to 5.8 kgf-cm (5.0 lbf-in).

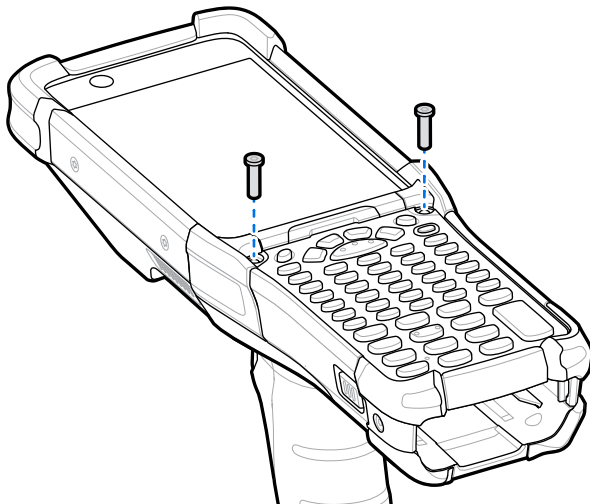

14. Turn the device over.
15. Using a long, thin  T8 screwdriver, replace the two screws and washers inside the battery slot and torque to 5.8 kgf-cm (5.0 lbf-in).

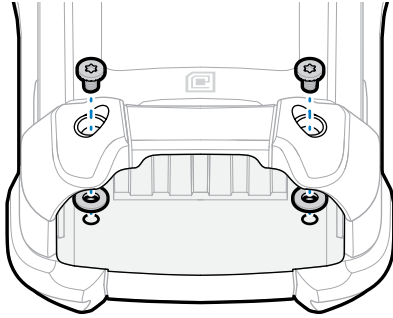

16. Insert the battery.
17. Press and hold **Power** to power on the device.

Installing the Battery

This section describes how to install the battery into the device.

1. Align the battery with the battery slot.
2. Push the battery into the battery slot.

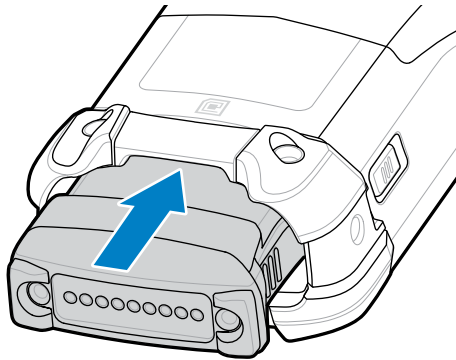

3. Press the battery firmly into the battery well.

Ensure that both the battery release latches on the sides of the device return to the home position. An audible click sound indicates that both the battery release latches have returned to the home position, locking the battery in place.

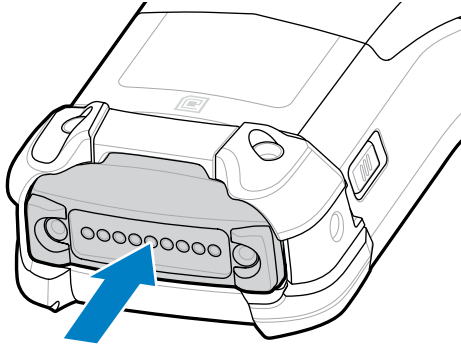

4. Press **Power** to turn on the device.

Replacing the Battery

This section describes how to replace the battery in the device.

1. Push in the two primary battery release latches.

The battery ejects slightly. With Hot Swap mode, when you remove the battery, the display turns off, and the device enters a low-power state. The device retains RAM data for approximately 5 minutes. Replace the battery within 5 minutes to preserve memory persistence.

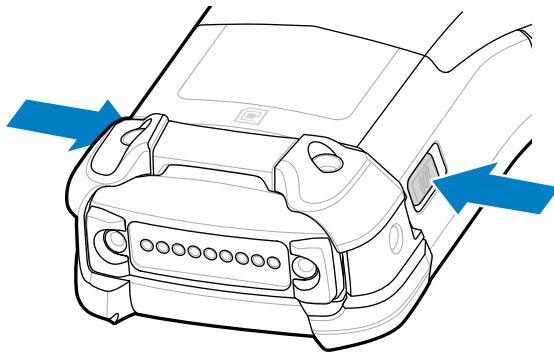

2. Push in the secondary battery release latches on the sides of the battery.

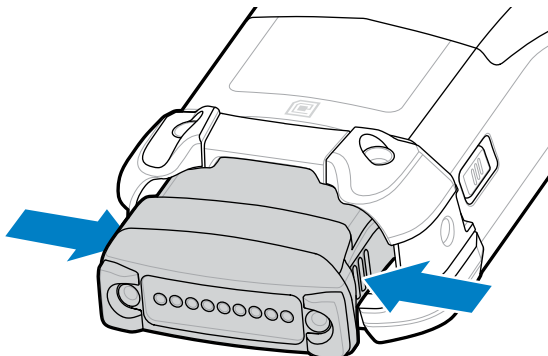

3. Remove the battery from the battery slot.

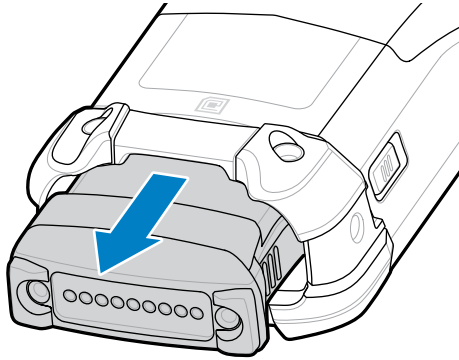

4. Align the battery with the battery slot.

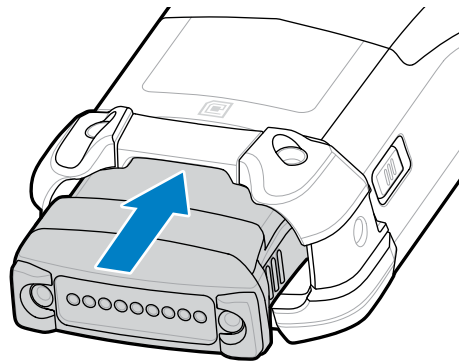

5. Push the battery into the battery slot.

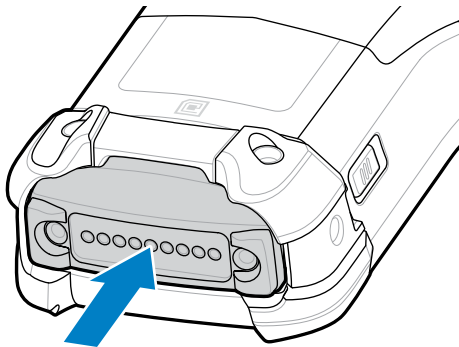

6. Press the battery firmly into the battery well.

Ensure that both the battery release latches on the sides of the device return to the home position. You will hear an audible click sound indicating that both the battery release latches have returned to the home position, locking the battery in place.

7. Press **Power** to turn on the device.

Charging the Device

To achieve optimal charging results, use only Zebra charging accessories and batteries. Charge batteries at room temperature with the device in sleep mode.

A standard battery charges from fully depleted to 90% in approximately 4 hours and from fully depleted to 100% in approximately 5 hours. In many cases, a 90% charge provides enough charge for daily use. Depending on the usage profile, a full 100% charge may last for approximately 14 hours of use.



NOTE: Follow the guidelines for battery safety described in the Batter Best Practices file available at zebra.com/powerprecision.

The device or accessory always performs battery charging in a safe and intelligent manner. The device or accessory indicates when charging is disabled due to abnormal temperatures via its LED, and a notification appears on the device display.

Temperature	Battery Charging Behavior
0°C to 40°C (32°F to 104°F)	Optimal charging range.
0 to 20°C (32 to 68°F) 37 to 40°C (98 to 104°F)	Charging slows to optimize the JEITA requirements of the cell.
Below 0°C (32°F) Above 40°C (104°F)	Charging stops.
Above 58°C (136°F)	The device shuts down.

To charge the device using a cradle:

1. Connect the cradle to the appropriate power source.

2. Insert the device into the slot in the cradle to begin charging. Gently press down on the device to ensure that it is properly seated.

Figure 3 1-Slot USB Charge Cradle with Spare Battery Charger

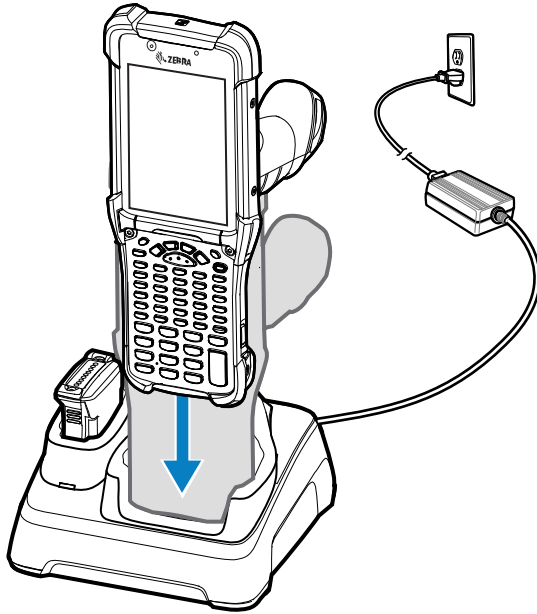

The device turns on and begins charging. The charging/notification LED indicates the battery charging status.

3. When charging is complete, remove the device from the cradle slot.

See Also

[Charging Indicators](#)

Charging the Spare Battery

1. Connect the charger to a power source.
2. Insert the battery into a spare battery charging slot and gently press down on the battery to ensure proper contact. The spare battery charging LEDs on the front of the cradle indicates the spare battery charging status.
3. When charging is complete, remove the battery from the charging slot.

Charging Indicators

The Charge LED Indicator indicates the charge status.

Table 1 LED Charge Indicators

Status	Indications
Off	<ul style="list-style-type: none"> • The battery is not charging. • The device is not inserted correctly in the cradle or connected to a power source. • The device is not powered.
Slow Blinking Amber Every 3 seconds	<ul style="list-style-type: none"> • The battery is charging, but it is fully depleted and does not yet have sufficient charge to power the device. • After battery removal, it indicates that the device is in hot swap mode with connectivity persistence. <p>The SuperCap requires a minimum of 15 minutes to fully charge in order to provide adequate connectivity and memory session persistence.</p>
Solid Amber	The battery is charging.
Solid Green	Battery charging is complete.
Fast Blinking Red 2 blinks/second	<p>Charging error. For example:</p> <ul style="list-style-type: none"> • Temperature is too low or too high. • Charging has gone on too long without completion (typically 8 hours).
Solid Red	<ul style="list-style-type: none"> • The battery is charging and is at the end of its useful life. • Charging is complete, and the battery is at the end of its useful life.

Using the Device

This section explains how to use the device.

Waking the Device

The device goes into Sleep mode when you press **Power** or after a period of inactivity (set in the Display settings window).

The device will wake on the detection of AC/DC power if it is either in suspend mode or powered off.

1. To wake the device from Sleep mode, press **Power** or the configured wake-up sources.

The Lock screen displays.

2. Swipe the screen up to unlock.

- If the screen option is set to Swipe, the Home screen displays.
- If either the PIN or Password screen unlock feature is enabled, a prompt displays. Enter the PIN or password to unlock the device and move to the Home screen.
- If the Pattern screen unlock feature is enabled, the Pattern screen displays. Swipe the correct pattern between the dots to unlock the device and move to the Home screen.



NOTE: If you enter the PIN, password, or pattern incorrectly five times, you must wait 30 seconds before trying again.

- If you forget the PIN, password, or pattern, contact your system administrator.

Home Screen

Turn on the device to display the Home screen. Depending on how your system administrator configured your device, your Home screen may appear differently than the graphics in this section.

After the device goes into Sleep mode, the Home screen displays with the lock icon. Touch the screen and swipe up to unlock. The Home screen provides four additional screens to place widgets and shortcuts. Touch and hold on an icon, and then move it for the option to place the icon on one of the other screens. Swipe the Home screen left or right to view the additional screens.

Figure 4 Home Screen



1	Status bar	Displays the time, status icons (right side), and notification icons (left side).
2	Widgets	Launches stand-alone apps that run on the Home screen.
3	Shortcut icons	Opens apps installed on the device.
4	Folder	Contains apps.
5	Back	Displays the previous screen.
6	Home	Displays the home screen.
7	Recent	Displays recently used applications.

Status Bar

The Status bar displays the time, notification icons (left side), and status icons (right side).

If there are more notifications than can fit in the Status bar, a dot displays indicating that more notifications exist. Swipe down from the Status bar to open the Notification panel and view all notifications and status.

Figure 5 Notifications and Status Icons



1	Notification icons
2	Status icons





Notification Icons

Notification icons indicate app events and messages.

Table 2 Notification Icons

Icons	Description
	Main battery is low.
	More notifications are available for viewing.
	Data is syncing.
	Indicates an upcoming event. GMS devices only.
	Open Wi-Fi network is available.
	Audio is playing.
	Problem with sign-in or sync has occurred.
	Device is uploading data.
	Animated: the device is downloading data. Static: the download is complete.
	Device is connected to or disconnected from a virtual private network (VPN).
	Preparing internal storage by checking it for errors.
	USB debugging is enabled on the device.

Table 2 Notification Icons (Continued)

Icons	Description
	PTT Express Voice client status.
	Indicates the RxLogger app is running.
	Indicates the Bluetooth scanner is connected to the device.
	Indicates the ring scanner is connected to the device in HID mode.

Status Icons

Status icons display system information for the device.

Table 3 Status Icons



























Icon	Description
	Alarm is active.
	Main battery is fully charged.
	Main battery is partially drained.
	Main battery charge is low.
	Main battery charge is very low.
	Main battery is charging.
	Problem reading the battery meter.
	All sounds, except media and alarms, are muted. Vibrate mode is active.
	All sounds except media and alarms are muted.
	Do Not Disturb mode active.

Table 3 Status Icons (Continued)



Icon	Description
	Airplane Mode is active. All radios are turned off.
	Bluetooth is on.
	Connected to a Bluetooth device.
	Connected to a Wi-Fi network. Indicates the Wi-Fi version number.
	Not connected to a Wi-Fi network or no Wi-Fi signal.
	Connected to an Ethernet network.
	Speakerphone enabled.
	Indicates that the Orange key is locked.
	Indicates that the Blue key is pressed.
	Indicates that the Blue key is locked.
	Indicates that the ALT key is pressed.
	Indicates that the CTRL key is pressed.
	Indicates that the Shift key is pressed.
	Indicates that the Shift key is locked.
	Indicates that the Large Key Indicator is selected. To enable the large key indicator, go to Settings > System > Languages & input > Advanced > Keypad Indicators .
	Indicates that the Blue Key and SHIFT key are pressed enabling CAPSLOCK.

Special Keys

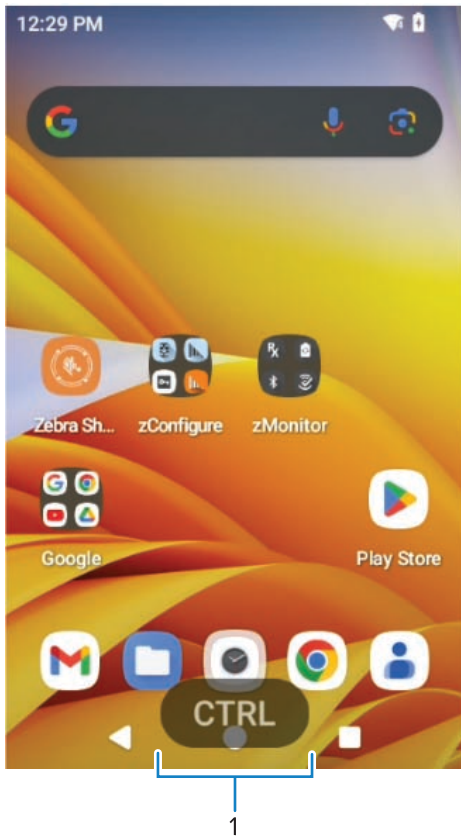
The lower part of the home screen displays if certain special keys are active.



	<p>Indicates that the Blue key is pressed.</p>
	<p>Indicates that the Blue key is locked.</p>
	<p>Indicates that the ALT key is pressed.</p>
	<p>Indicates that the CTRL key is pressed.</p>

	<p>Indicates that the Shift key is pressed.</p>
	<p>Indicates that the Shift key is locked.</p>

Managing Notifications

Notification icons report the arrival of new messages, calendar events, alarms, and ongoing events. When a notification occurs, an icon appears in the Status bar with a brief description.

Figure 6 Notification Panel

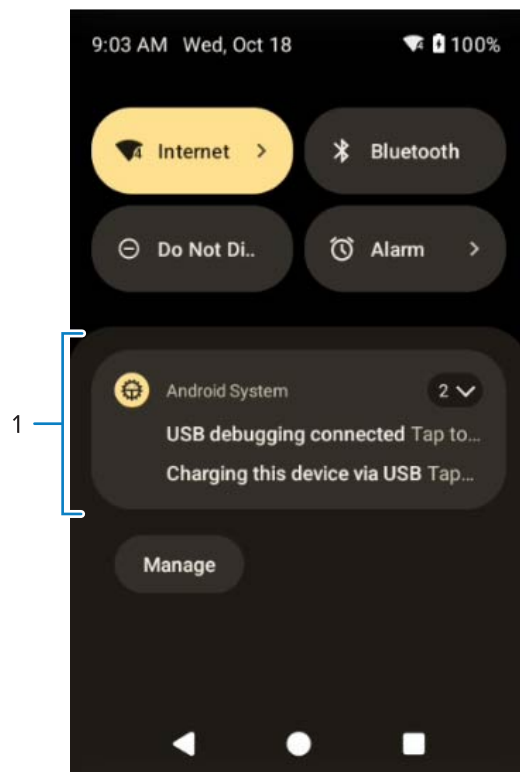

1	Notifications
---	---------------

- To view a list of all notifications, open the Notification panel by dragging the Status bar down from the top of the screen.
- To respond to a notification, open the Notification panel and then touch a notification. The Notification panel closes and the corresponding app opens.
- To manage recent or frequently used notifications, open the Notification panel and then touch Manage notifications. Touch the toggle switch next to an app to turn off all notifications, or touch an app for more notification options.

- To clear all notifications, open the Notification panel and then touch **Clear all**. All event-based notifications are removed. Ongoing notifications remain in the list.
- To close the Notification panel, swipe the Notification panel up.

Opening the Quick Access Panel

Use the Quick Access panel to access frequently used settings (for example, Airplane mode).



NOTE: Not all icons are pictured. Icons may vary.

Figure 7 Quick Access Panel

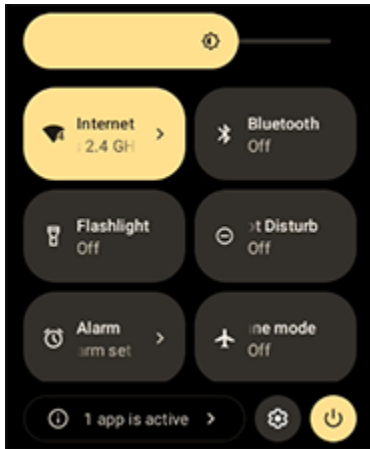

- If the device is locked, swipe down once.
- If the device is unlocked, swipe down once with two fingers, or twice with one finger.
- If the Notification panel is open, swipe down from the Quick Settings bar.

Quick Access Panel Icons

Quick Access panel icons indicate frequently used settings (for example, Airplane mode).

Table 4 Quick Access Icons

Icon	Description
	Display brightness - Use the slider to decrease or increase the brightness of the screen.
	Internet/Wi-Fi network - Turn Wi-Fi on or off. To open Wi-Fi settings, touch the Wi-Fi network name.
	Bluetooth settings - Turn Bluetooth on or off. To open Bluetooth settings, touch Bluetooth.
	Do not disturb - Control how and when to receive notifications.

Table 4 Quick Access Icons (Continued)





















Icon	Description
	Flashlight - Turn the flashlight or camera flash on or off. When the flashlight is activated, it stays on unless it is turned off or the camera app is run.
	Auto-rotate - Lock the device's orientation in portrait or landscape mode or set to automatically rotate.
	Wallet - Opens Android wallet.
	Alarm - Opens the Alarm app.
	Battery saver - Turn Battery saver mode on or off. When Battery saver mode is on the performance of the device is reduced to preserve battery power (not applicable).
	Airplane mode - Turn Airplane mode on or off. When Airplane mode is on the device does not connect to Wi-Fi or Bluetooth.
	Screen Cast - Share phone content on Chromecast or a television with Chromecast built-in. On the Cast screen, check the "enable wireless display" option, and then touch "cast screen" to display a list of devices. Touch a device in the list to begin casting.
	Screen Record - Makes a video recording of everything that happens on the screen, with options to include audio and screen touches.
	NFC - Enable or disable NFC communication.
	Nearby Share - Helps find and interact with services and devices close to the device.
	Night Light - Tint the screen amber to make it easier to look at the screen in dim light. Set Night Light to turn on automatically from sunset to sunrise, or at other times.
	Hotspot - Turn on to share the device's mobile data connection with other devices.
	Invert colors - Invert the display colors.
	Data Saver - Turn on to prevent some apps from sending or receiving data in the background.

Table 4 Quick Access Icons (Continued)

Icon	Description
	Dark Theme - Toggles dark theme on and off. Dark themes reduce the luminance emitted by the screen, while meeting minimum color contrast ratios. It helps improve visual ergonomics by reducing eye strain, adjusting brightness to current lighting conditions, and facilitating screen use in dark environments, while conserving battery power.
	Color correction - Enable to help your device compensate for color blindness.
	Focus mode - Turn on to pause distracting apps. To open Focus mode settings, touch and hold.
	Bedtime mode - Turn grayscale on and off. Grayscale turns the screen black and white, reducing phone distractions and improving battery life.
	Live caption - Enables captions to appear for any media playing, regardless of the device's volume level.
	Calculator - Open the calculator app.

Editing the Quick Access Tiles

The first four setting tiles from the Quick Access panel become the Quick Access tiles on the Notification panel.

Figure 8 Notification Panel

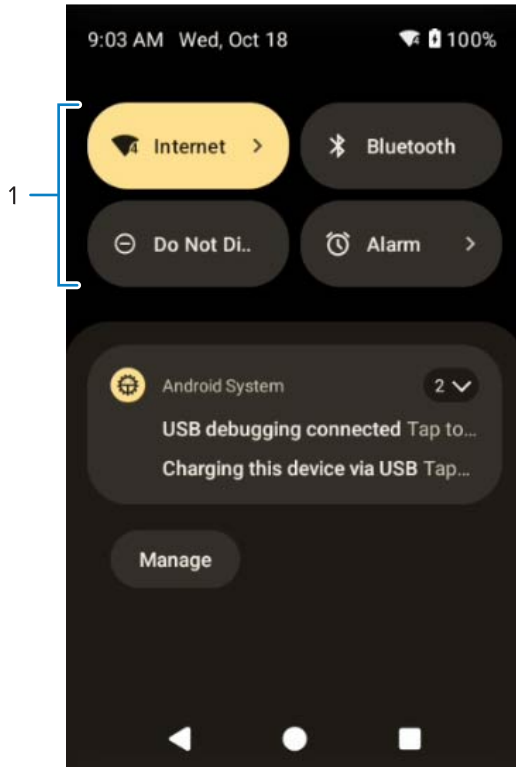

1	Quick access tiles
---	--------------------

- Open the Quick Access panel and touch  to edit, add, or remove settings tiles.

Battery Management

Observe the recommended battery optimization tips for the device.

- Set the screen to turn off after a short period of inactivity.
- Reduce screen brightness.
- Turn off all wireless radios when not in use.
- Turn off automatic syncing for Email, Calendar, Contacts, and other apps.
- Minimize the use of apps that keep the device from sleeping, for example, music and video apps.



NOTE: Before checking the battery charge level, remove the device from any AC power source (cradle or cable).

Checking Battery Status

Check the battery status through the Battery Information settings, the Battery Manager app, or the quick access panel.

- Open **Settings** and touch **About phone > Battery Information**. Or swipe up from the bottom of the screen and touch  to open the **Battery Manager** app.

Battery present status indicates if the battery is present.

Battery level lists the battery charge (as a percentage of fully charged).

- Swipe down with two fingers from the status bar to open the quick access panel.

The **battery percentage** is displayed next to the battery icon.

Low Battery Notification

When the battery charge level drops below the change level in the table below, the device displays a notice to connect the device to power. Charge the battery using one of the charging accessories.

Table 5 Low Battery Notification

Charge Level Drops Below	Action
15% (Standard battery)	The user should charge the battery soon.
30% (Freezer battery)	The user should charge the battery soon.
9% (Standard battery)	The user must charge the battery.
20% (Freezer battery)	The user must charge the battery.
6% (Standard battery)	The device turns off. The user must charge the battery.
6% (Freezer battery)	The device turns off. The user must charge the battery.

Monitoring Battery Usage

The Battery screen provides battery charge details and power management options to extend battery life.

1. Go to **Settings**.
2. Touch **Battery**.

The device displays the battery settings and options.

Monitoring App Battery Usage

Different apps may provide different battery usage information. Some apps include buttons that open screens with settings to adjust power use.

1. Go to **Settings**.
2. Touch **Apps**.
3. Touch **All Apps**.
4. Touch an app.

5. Touch **App Battery Usage**.

You may choose to turn off the app if it consumes too much power.

- Use **FORCE STOP** to close the app.
- Use **DISABLE** to deactivate the app.

USB Communication

Connect the device to a host computer to transfer files between the device and the host computer.

When connecting the device to a host computer, follow the host computer's instructions for connecting and disconnecting USB devices, to avoid damaging or corrupting files.

Transferring Files

Use Transfer files to copy files between the device and the host computer.

1. Connect the device to a host computer using a USB accessory.
2. On the device, pull down the Notification panel and touch **Charging this device via USB**.
By default, **No data transfer** is selected.
3. Touch **File Transfer**.



NOTE: After changing the setting to **File Transfer**, and then disconnecting the USB cable, the setting reverts back to **No data transfer**. If the USB cable is reconnected, select **File Transfer** again.

4. On the host computer, open **File Explorer**.
5. Locate the **device** as a portable device.
6. Open the **Internal storage** folder.
7. Copy files to and from the device or delete files as required.

Transferring Photos

Use PTP to copy photos from the device to the host computer.

It is recommended to install a microSD card in the device for storing photos due to limited internal storage.

1. Connect the device to a host computer using a USB accessory.
2. On the device, pull down the Notification panel and touch **Charging this device via USB**.
The USB Preferences screen displays.
3. Under **Use USB**, touch **PTP**.
4. Under **This PC**, touch **Transfer photos PTP**.
5. On the host computer, open **File Explorer**.
6. Under **This PC**, locate the device and open it.
7. Open the SD card or the Internal shared storage folder.
8. Copy or delete photos as required.
9. On the USB Preferences screen under **Use USB**, touch **No data transfer** to end the transfer process.

Disconnecting from the Host Computer



CAUTION: Carefully follow the host computer's instructions to disconnect USB devices correctly to avoid losing information.

1. On the host computer, unmount the device.
2. Remove the device from the USB accessory.

Interactive Sensor Technology

To take advantage of these sensors, applications use API commands. Refer to the Google Android Sensor APIs for more information. For information on the Zebra Android EMDK, go to: techdocs.zebra.com.

The device contains sensors that monitor movement, orientation, and ambient light.



- Gyroscope - Measures angular rotational velocity to detect rotation of the device.
- Accelerometer - Measures the linear acceleration of movement to detect the orientation of the device.
- Light Sensor - Detects ambient light and adjusts the screen brightness.

Settings

This section describes the settings on the device.

Accessing Settings

There are multiple ways to access settings on a device.

- Swipe down with two fingers from the top of the Home screen to open the Quick Access panel and touch .
- Double-swipe down from the top of the Home screen to open the Quick Access panel and touch .
- Swipe up from the bottom of the Home screen to open APPS and touch **Settings**.

Display Settings

Use Display settings to change the screen brightness, enable night light, change the background image, enable screen rotation, set screen timeout, and change font size.

You can also control the keyboard backlight.

Setting the Screen Brightness Manually

Manually set the screen brightness using the touchscreen.

To manually set the screen brightness using the keypad also see Keypad Special Functions.

1. Swipe down with two fingers from the Status bar to open the Quick Access panel.
2. Slide  left or right to adjust the screen brightness level.

Setting the Screen Brightness Automatically

Automatically adjust the screen brightness using the built-in light sensor.

1. Go to **Settings**.
2. Touch **Display**.
3. If disabled, touch **Adaptive brightness** to automatically adjust the brightness.

By default, **Adaptive brightness** is enabled. Toggle the switch to disable.

Setting Night Light

The Night Light setting tints the screen amber, making the screen easier to look at in low light.

1. Go to **Settings**.
2. Touch **Display > Night Light > Schedule**.
3. Select one of the schedule values:
 - **None (default)**
 - **Turns on at a custom time**
 - **Turns on from sunset to sunrise**
4. By default, **Night Light** is disabled. Touch **Use Night Light** to enable.
5. Adjust the tint using the **Intensity** slider.

Setting the Screen Timeout Value

The screen turns off and goes into Suspend mode after the selected period of inactivity. The **Screen attention** feature uses the front camera to determine if you are looking at the screen and prevents the screen from turning off if you are.

1. Go to **Settings**.
2. Touch **Display > Screen timeout**.
3. Select one of the sleep values.
 - **15 seconds**
 - **30 seconds**
 - **1 minute**
 - **2 minutes**
 - **5 minutes**
 - **10 minutes**
 - **30 minutes (default)**
 - **Never**

Setting Screen Rotation

By default, screen rotation is disabled.



NOTE: To change the Home screen rotation, see [Setting Home Screen Rotation](#).

1. Go to **Settings**.
2. Touch **Display > Auto-rotate screen**.

Setting Font Size

Set the size of the font in system apps.

1. Go to **Settings**.
2. Touch **Display > Display size and text**.
3. Scroll to **Font size**.
4. Select a font size option:
 - **Small**
 - **Default**
 - **Large**
 - **Largest**

Setting Display Size

By default, the display size is set to Default.

1. Go to **Settings**.
2. Touch **Display > Display size and text**.
3. Scroll to **Display size**.
4. Touch - and + to change the display size.
 - **Small**
 - **Default**
 - **Large**

Setting the Lock Screen Notifications

The lock screen display setting wakes the screen when notifications are received.

1. Go to **Settings > Display > Lock screen**.
2. Enable or disable the desired options.

Setting the Touch Panel Mode

The device display is able to detect touches using a finger, a conductive-tip stylus, or a gloved finger.



NOTE: A glove can be made of medical latex, leather, cotton, or wool. For optimal performance, use a Zebra-certified stylus.

1. Go to **Settings**.
2. Touch **Display > Touch panel mode**.

3. Select one of the following:
 - **Stylus and Finger (Screen Protector OFF)** to use a finger or a stylus on the screen without a screen protector.
 - **Glove and Finger (Screen Protector OFF)** to use a finger or a gloved finger on the screen without a screen protector.
 - **Stylus and Finger (Screen Protector ON)** to use a finger or a stylus on the screen with a screen protector.
 - **Glove and Finger (Screen Protector ON)** to use a finger or a gloved finger on the screen with a screen protector.
 - **Finger Only** to use a finger on the screen.

Setting Keyboard Backlight

The intensity of the keyboard backlight and the conditions under which this backlight is activated can be configured by opening the Keyboard Light settings.

1. Go to **Settings**.
2. Touch **Display > Keyboard backlight**.
3. Touch **Keyboard light level**.

A slider appears.
4. Adjust the light level by sliding the icon. Change level by 10% increments.
5. Touch **Keyboard light timeout**.

The Keyboard light timeout dialog appears.
6. Select the amount of time that the backlight stays on before turning off:
 - **6 seconds** (default)
 - **10 seconds**
 - **15 seconds**
 - **30 seconds**
 - **1 minute**
 - **2 minutes**
 - **5 minutes**
 - **Always on**
7. Enable **Adaptive keyboard brightness** to optimize the setting for available light.

Setting the Date and Time

The date and time are automatically synchronized using a NITZ server when the device is connected to a cellular/wireless network. You are only required to set the time zone or set the date and time if the wireless LAN does not support Network Time Protocol (NTP) or when not connected to a cellular/wireless network.

1. Go to **Settings**.
2. Touch **System > Date & time**.

3. Touch **Set time automatically** to disable automatic date and time synchronization.
The Date and Time options are enabled for editing.
4. Touch **Use network-provided time zone** to disable automatic time zone synchronization.
5. Touch **Date** to select the date in the calendar.
6. Touch **OK**.
7. Touch **Time**.
 - a) Touch the circle, drag to the current hour, and then release.
 - b) Touch the circle, drag to the current minute, and then release.
 - c) Touch **AM** or **PM**.
8. Touch **OK**.
9. Touch **Time zone** to select the current time zone from the list.
10. Touch **Update Interval** to select an interval to synchronize the system time from the network.
11. In **TIME FORMAT**, choose either **Use locale default** or **Use 24-hour format**.

General Sound Setting

Press the volume buttons on the device to display on-screen volume controls.

Use the Sound settings to configure media and alarm volumes.

1. Go to **Settings**.
2. Touch **Sound & vibration**.
3. Touch an option to set sounds.

Sound Options

- **Volume settings:**
 - **Media volume** - Controls the music, games, and media volume.
 - **Call volume** - Controls the volume during a call.
 - **Notification volume** - Controls the notification volume.
 - **Alarm volume** - Controls the alarm clock volume.
- **Do Not Disturb** - Mutes some or all sounds and vibrations.
- **Live Caption** - Automatically caption speech.
- **Media** - Shows the media player in Quick Settings while sound is playing, allowing quick access.
- **Vibration & haptics:**
 - **Ring vibration** - Vibrate the device when the phone rings.
 - **Notification vibration** - Vibrate the device when a notification comes in.
 - **Alarm vibration** - Vibrate the device when an alarm goes off.
 - **Touch feedback** - Vibrate the device when making screen selections.
 - **Media vibration** - Enable vibration when using a media player.

- **Shortcut to prevent ringing** - Select how the shortcut method prevents ringing.
- **Default notification sound** - Select a sound to play for all system notifications.
- **Default alarm sound** - Select a sound to play for alarms.
- **Other sounds and vibrations:**
 - **Screen locking sound** - Play a sound when locking and unlocking the screen (default – enabled).
 - **Charging sounds and vibration** - Play a sound and vibrate when power is applied to the device (default - enabled).
 - **Touch sounds** - Play a sound when making screen selections (default – enabled).
 - **Always show icon when in vibrate mode**- Enable the vibrate mode status bar icon.

Setting Wake-Up Sources

By default, the device wakes from Sleep mode when the user presses **Power**. The device can be configured to wake when the user presses **PTT** or **Scan**.

1. Go to **Settings**.
2. Touch **Wake-Up Sources**.
 - **GRIP_TRIGGER**
 - **P1**
 - **SCAN**
3. Touch a checkbox.

A check appears in the checkbox.

Remapping a Button

Buttons on the device can be programmed to perform different functions or as shortcuts to installed apps. For a list of key names and descriptions, refer to: techdocs.zebra.com.



NOTE: It is not recommended to remap the scan button.

1. Go to **Settings**.
2. Touch **Key Programmer**. A list of programmable buttons displays.
3. Select a button to remap.
4. Touch the **Shortcut** tab, the **Keys and Buttons** tab, or the **Trigger** tab.

The tabs list the available functions and applications.

5. Touch a function or application shortcut to map to the button.



NOTE: If you select an application shortcut, the application icon appears next to the button on the Key Programmer screen.

Keyboards

The device provides multiple keyboard options.

- Gboard - GMS devices only
- Physical Keyboard



NOTE: By default, the Enterprise and Virtual Keyboards are disabled. The Enterprise Keyboard is available for download from the [Zebra Support Site](#).

Keyboard Configuration

This section describes configuring the device's keyboard.



Enabling Virtual Keyboards

Enable a virtual keyboard like Gboard or [Enterprise keyboard](#).

1. Go to **Settings**.
2. Touch **System > Languages & input**.
3. In the **KEYBOARDS** section, touch **Physical keyboard**.
4. In the **Physical keyboard** section, enable **Use on-screen keyboard**.

Switching Between Keyboards

To switch between keyboards, touch in a text box to display the current keyboard.

- On the Gboard keyboard, touch and hold  (GMS devices only).
- On the Android keyboard, touch, and hold  (AOSP devices only).
- On the Enterprise keyboard, touch . Only available with Mobility DNA Enterprise License. Not preinstalled on the device. Contact Zebra Support for more information.

Using the Android and Gboard Keyboards

Use the Android or Gboard keyboards to enter text in a text field.

- To configure the keyboard settings, touch and hold "," (comma) and then select **Android keyboard settings**.

Edit Text

Edit entered text and use menu commands to cut, copy, and paste text within or across apps. Some apps do not support editing some or all of the text they display; others may offer their own way to select text.

Entering Numbers, Symbols, and Special Characters

1. Enter numbers and symbols.
 - Touch and hold one of the top-row keys until a menu appears then select a number or special character.
 - Touch the Shift key once for a single capital letter. Touch the Shift key twice to lock in uppercase. Touch the Shift key a third time to unlock Capslock.
 - Touch **?123** to switch to the numbers and symbols keyboard.
 - Touch the =\< key on the numbers and symbols keyboard to view additional symbols.
2. Enter special characters.
 - Touch and hold a number or symbol key to open a menu of additional symbols. A larger version of the key displays briefly over the keyboard.

Enterprise Keyboard

The Enterprise Keyboard contains multiple keyboard types.



NOTE: Only available with Mobility DNA Enterprise License.

- Numeric
- Alpha
- Special characters
- Data capture.

Numeric Tab

The numeric keyboard is labeled **123**. The keys displayed vary on the app being used. For example, an arrow displays in **Contacts**, however **Done** displays in **Email** account setup.

Alpha Tab

The alpha keyboard is labeled using the language code. For English, the alpha keyboard is labeled **EN**.

Additional Character Tab

The additional characters keyboard is labeled **#*/**.

- Touch 😊 to enter emoji icons in a text message.
- Touch **ABC** to return to the Symbols keyboard.

Scan Tab

The Scan tab provides an easy data capture feature for scanning barcodes.

Language Usage

Use the **Language & input** settings to change the device's language, including words added to the dictionary.

Changing the Language Setting

1. Go to **Settings**.
2. Touch **System > Languages & input**.
3. Touch **Languages**.
A list of available languages displays.
4. If the desired language is not listed, touch **Add a language** and select a language from the list.
5. Touch and hold  to the right of the desired language, then drag it to the top of the list.
The operating system text changes to the selected language.

Adding Words to the Dictionary

1. Go to **Settings**.
2. Touch **System > Languages & input > Personal dictionary**.
3. If prompted, select the language where this word or phrase is stored.
4. Touch + to add a new word or phrase to the dictionary.
5. Enter the word or phrase.
6. In the Shortcut text box, enter a shortcut for the word or phrase.
7. Save or cancel the changes:
 - To exit and save the word, click the back arrow.
 - To cancel, click the trash can icon in the top-right corner.

Notifications

The user can configure notifications for the device and for specific apps. Device notifications settings allow you to configure how notifications occur on the device. App notification settings allow you to configure how notifications occur for a specific app.

To view device notification settings, touch **Settings > Notifications**.

To view app notifications, touch **Settings > Apps > All Apps**. Select an app, and then touch **Notifications**.

Enabling Blink Light

The Notification LED lights blue when an app, such as email and VoIP, generates a programmable notification or to indicate when the device is connected to a Bluetooth device. By default, LED notifications are enabled.

1. Touch **Settings** > **Notifications** .
2. Touch **Blink light** to toggle the notification on or off.

Applications

Apart from the standard pre-installed Android applications, the following table lists Zebra-specific applications installed on the device.

Installed Applications

Aside from the common Google apps, the Zebra-specific apps that are installed on the device are described in this section.

Table 6 Apps















Item	Description
	Battery Manager - Displays battery information, including charge level, status, health and wear levels. Use to place the device in Battery Swap mode (non-premium models only) when replacing the battery.
	Bluetooth Pairing Utility – Use to pair a Zebra Bluetooth scanner with the device by scanning a barcode.
	DataWedge - Enables data capture using the imager.
	DWDemo - Provides a way to demonstrate the data capture features using the imager.
	Enterprise Browser - Industrial browser that provides everything needed to quickly build device apps for barcode scanning, signature capture, payment processing, printing, and most other enterprise applications. For more information, go to techdocs.zebra.com/enterprise-browser/ .
	License Manager - Use to manage software licenses on the device.
	RxLogger - Use to diagnose device and app issues.

Table 6 Apps (Continued)

Item	Description
	StageNow - Allows the device to stage a device for initial use by initiating the deployment of settings, firmware, and software.
	Velocity - Opens the Ivanti (formerly Wavelink) terminal emulation app.
	VoD - The Video on Device basic app provides a how-to video for proper device cleaning. For Video on Device licensing information, contact learningservices@zebra.com .
	Wireless Analyzer - A diagnostic intelligent app. Use to diagnose surrounding area and display network stats, such as coverage hole detection or AP in the vicinity. Refer to the Worry Free Wi-Fi Analyzer Administrator Guide for Android. Only available with Mobility DNA Enterprise License.
	Zebra Bluetooth Settings - Use to configure Bluetooth logging.
	Zebra Data Services - Use to enable or disable Zebra Data Services. Some options are set by the system administrator.
	Zebra Showcase - Provides a way to experience and learn about Zebra's new or existing capabilities.

Accessing Apps

Access all apps installed on the device using the APPS window.

1. On the Home screen, swipe up from the bottom of the screen.
2. Slide the **APPS** window up or down to view more app icons.
3. Touch an icon to open the app.

Switching Between Recent Apps

1. Touch **Recent**.
A window appears on the screen with icons of recently used apps.
2. Swipe left or right to view all recently used apps.
3. Slide an app up to remove it from the list and force close the app.
4. Touch an icon to open an app or touch **Back** to return to the current screen.

Battery Manager

The Battery Manager provides detailed information about the battery.

This section also provides battery swap procedures for supported devices.



Opening Battery Manager

- To open the Battery Manager app, swipe up from the bottom of the Home screen, and then touch .

Battery Manager Information

The Battery Manager displays detailed information about battery charging, health, and status.

Table 7 Battery Icons

Battery Icon	Description
	Battery charge level is between 85% and 100%.
	Battery charge level is between 19% and 84%.
	Battery charge level is between 0% and 18%.

- Level** - The current battery charge level as a percentage. Displays -% when the level is unknown.
- Wear** - The health of the battery in graphical form. When the wear level exceeds 80%, the bar color changes to red.
- Health** - The health of the battery. If a critical error occurs,  appears. Touch to view the error description.
 - Decommission** - The battery is past its useful life and should be replaced. See system administrator.
 - Good** - The battery is good.
 - Charge error** - An error occurred while charging. See system administrator.
 - Over Current** - An over-current condition occurred. See system administrator.
 - Dead** - The battery has no charge. Replace the battery.
 - Over Voltage** - An over-voltage condition occurred. See system administrator.
 - Below Temperature** - The battery temperature is below the operating temperature. See system administrator.
 - Failure Detected** - A failure has been detected in the battery. See system administrator.
 - Unknown** - See system administrator.

- **Charge Status**
 - **Not charging** - The device is not connected to AC power.
 - **Not charging** - The device is not charging.
 - **Charging-AC** - The device is connected to AC power and charging or is fast charging via USB.
 - **Charging-USB** - The device is connected to a host computer with a USB cable and charging.
 - **Discharging** - The battery is discharging.
 - **Full** - The battery is fully charged.
 - **Unknown** - The battery status is unknown.
- **Time until Full** - The amount of time until the battery is fully charged.
- **Time since charging** - The amount of time since the device began charging.
- **Time until empty** - The amount of time until the battery is empty.
- **Advanced info** - Touch to view additional battery information.
 - **Battery present status** - Indicates that the battery is present.
 - **Battery level** - The battery charge level as a percentage of scale.
 - **Battery scale** - The battery scale level used to determine battery level (100).
 - **Battery voltage** - The current battery voltage in millivolts.
 - **Battery temperature** - The current battery temperature in degrees Centigrade.
 - **Battery technology** - The type of battery.
 - **Battery current** - The average current into or out of the battery over the last second in mAh.
 - **Battery manufacture date** - The date of manufacture.
 - **Battery serial number** - The battery serial number. The number matches the serial number printed on the battery label.
 - **Battery part number** - The battery part number.
 - **Battery decommission status** - Indicates if the battery is past its life span.
 - **Battery Good** - The battery is in good health.
 - **Decommissioned Battery** - The battery is past its useful life and should be replaced.
 - **Base cumulative charge** - Cumulative charge using Zebra charging equipment only.
 - **Battery present capacity** - Maximum amount of charge that could be pulled from the battery under the present discharge conditions if the battery were fully charged.
 - **Battery health percentage** - With a range from 0 to 100, this is the ratio of “present_capacity” to “design_capacity” at a discharge rate of “design_capacity”.
 - **% decommission threshold** - The default % decommission threshold for a gifted battery as 80%.
 - **Battery present charge** - Amount of usable charge remaining in the battery at present under the current discharge conditions.
 - **Battery total cumulative charge** - The total accumulated charge in all chargers.
 - **Battery time since first use** - The time passed since the battery was placed in a Zebra terminal for the first time.
 - **Battery error status** - The error status of the battery.

- **App version** - The application version number.

Heater Control

The Heater Control application provides information about the sensors and heater applicable to the freezer device. To open the Heater Control, swipe up from the bottom of the Home screen and touch .



IMPORTANT: The Heater Control app is only applicable to freezer configurations.

The scanner exit window heater ensures optimum scanner performance in freezer applications.

The Status tab displays the following details:

- **Temperature**
 - Display
 - MLB
 - Scanner
 - Vent
 - Scanner Window
 - Scanner Bay.
- **Humidity**
 - Scanner
 - Vent
- **Heater**
 - Touch Panel Heater (default - disabled). This option should always be enabled for the heater to function properly. Disable this option only if you are performing debugging activities on the heater system.
 - Scanner Window Heater (default - enabled). This option should always be enabled for the heater to function properly. Disable this option only if you are performing debugging activities on the heater system.

The Advanced tab displays the following details:

- In the Heater area, tap to disable Scanner Window Heater. (default - enabled).
- In the Advanced area, tap to enable Logging. Logging allows you to log data for the heating system (heaters and sensors). The data resides in the `/sdcard/Android/data/com.symbol.heatercontrolserv/files/HeaterLogs/` location in a .csv file on the device.
- Click TEST HEATER to perform a diagnostic test on the heating system.



NOTE: Heater tests must be performed in an ambient environment with a temperature of less than +30° C (86° F).

After the tests are complete, the results screen displays.

Camera

The device has two integrated digital cameras, a rear-facing 16MP and a front-facing 8MP. This section provides information for taking photos and recording videos.



NOTE: The device saves photos and videos on the microSD card, if installed and the storage path is changed manually. By default, or if a microSD card is not installed, the device saves photos and videos on internal storage.

On this device, you can use the imager and camera simultaneously. By default, third-party camera applications are associated with the Datawedge Profile0 where scanning is enabled. In these applications, the Scan button initiates the scan session. If you do not want scanning to be enabled in the application, you must associate a new Datawedge profile with the application and disable scanning.



NOTE: The native Google camera application is associated with a hidden DataWedge profile. The scanning functionality is temporarily disabled when the Google camera application is being used. If a third-party camera application is utilized the scanning functionality will not be disabled allowing the simultaneous use of the scanner and the camera. This will have a direct impact on image quality. It is strongly recommended that you use the native Google camera application.

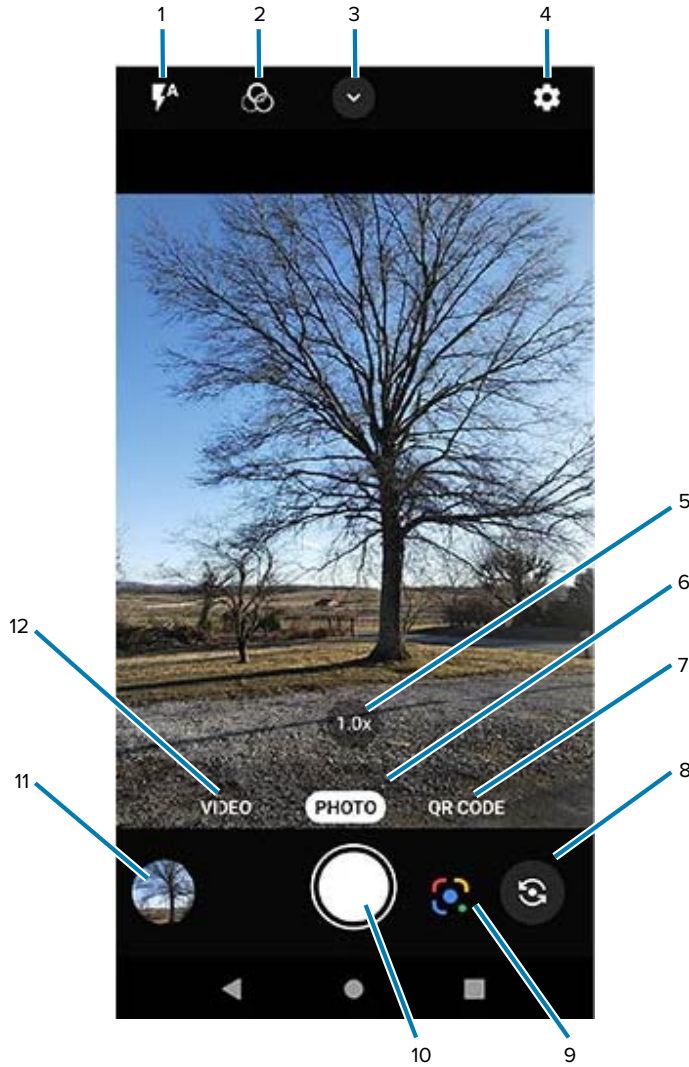

Taking Photos

1. Swipe up from the bottom of the Home screen and touch  to access the Camera application. Photo mode is the standard mode that displays.



1	Flash
2	Filters
3	Camera Quick Settings
4	Camera App Settings
5	Zoom
6	Photo mode
7	QR Code mode
8	Rear/front cameras

9	Google Lens app
10	Shutter button
11	Thumbnail of last photo or video
12	Video mode

2. To switch between the rear camera and front camera, touch .
3. Frame the subject on the screen.
4. Touch an area on the screen to focus. The yellow focus box displays and places that area into focus. Alternatively, the AutoFocus Animation can be enabled in the Settings menu, and the yellow focus box automatically appears when in focus.
5. To turn the Flash on, touch the  icon, which can also be accessed via the Quick Settings Menu.
6. To zoom in or out, the following options are available:
 - Tap the 1.0x zoom button to toggle between 1.0x and 2.0x.
 - Press and hold the **1.0x** zoom icon until the zoom slider displays. Slide the slider to the desired zoom.
 - Touch and hold an area with two fingers, then spread them apart to zoom in or pinch them together to zoom out.
7. Touch  to take a photo.
A shutter sound emits.

The last photo displays as a thumbnail in the lower-left corner.

See Also

[Camera Settings](#)

Recording Videos



1. Swipe up from the bottom of the Home screen and touch  to launch the Camera application.

2. Touch **Video** to access Video mode.



1	Flash
2	Filters
3	Camera Quick Settings
4	Camera App Settings
5	Zoom

6	Photo mode
7	QR Code mode
8	Rear/front cameras
9	Google Lens app
10	Record button
11	Thumbnail of last photo or video
12	Video mode

3. To switch between the rear camera and front camera, touch .
4. Point the camera and frame the scene.
5. Touch an area on the screen to focus. The yellow focus box displays and places that area into focus. Alternatively, the AutoFocus Animation can be enabled in the Settings menu and the yellow focus box automatically appears when in focus.
6. To turn the Flash on, touch the  icon which can also be accessed via the Quick Settings Menu.
7. Tap the 1.0x zoom button to toggle between 1.0x and 2.0x or press and hold the 1.0x zoom icon until the zoom slider displays and slide the slider to the desired zoom.

8. Touch the **Record** button. The video timer displays at the top of the screen.



1	Video timer
2	Audio
3	Zoom
4	Pause recording button
5	Start/stop recording button
6	Still image capture button (during video recording)

9. Touch the **Record** button to end the recording.



The last photo or video displays as a thumbnail in the lower-left corner.

Quick Camera Photo Mode and Video Mode Settings



Use the Quick Camera Settings to adjust commonly used settings.

In Photo mode, touch  to display the Quick Camera Setting options.

- **Flash** - Flash's light can compensate for the lack of brightness when shooting in dimly lit situations. Options: Auto, On, or Off.

Icon	Description
	Auto - Adjust the flash automatically depending upon the light meter (default).
	On - Enable the flash upon taking a photo.
	Off - Disable the flash.



- **Timer** - Select Off (default), 3 seconds, or 10 seconds.
- **White Balance** - Select how the camera adjusts colors in different kinds of light.

Icon	Description
	Auto - Adjust the white balance automatically (default).
	Incandescent - Adjust the white balance for incandescent lighting.
	Fluorescent - Adjust the white balance for fluorescent lighting.

- **Pro Mode** - Easy access to ISO, exposure, white balance, and focus advanced settings.



In Video mode, touch  prior to video recording to display the Quick Camera Setting options.

- **Flash** - Flash's light can compensate for the lack of brightness when shooting in dimly lit situations. Options: Auto, On, or Off.

Icon	Description
	Auto - Adjust the flash automatically depending upon the light meter (default).
	On - Enable the flash upon taking a photo.

Icon	Description
	Off - Disable the flash.

- **Resolution** - Select from options: 4K UHD, HD 1080p, SD 480p.
- **Audio** - Enable or disable the audio.
- **White Balance** - Select how the camera adjusts colors in different kinds of light.

Icon	Description
	Auto - Adjust the white balance automatically (default).
	Incandescent - Adjust the white balance for incandescent lighting.
	Fluorescent - Adjust the white balance for fluorescent lighting.

Camera and Video Settings

While in the Camera app, touch  to display the camera and video setting options.

General

- **Camera Sounds** - Select to play a shutter sound when taking a photo. Options: Disable or Enable (default).
- **Location Tags** - Includes location information when pictures and videos are taken.
- **Storage** – Set the location to store the photo to: Phone or SD Card.
- **Dirty Lens Detection** - Notifies when the camera lens might be dirty. Options: Disable (default) or Enable.
- **QR Code Mode** - Enable to scan QR Codes with the option to launch URL. Options: Disable (default) or Enable.
- **Google Lens** - Select to enable Google-developed recognition technology that brings up relevant information related to identified objects within an image.
- **Digital Level** - Display a level line to ensure the photo or video is level. Options: Disable (default) or Enable.
- **Face Detection** - Select to turn face detection Off (default) or On.
- **Gestures** - View gestures and power user controls. Gestures include: Swipe Down, Swipe Up, Side Swipe, Tap, Tap + Hold, Double Tap, and Hold Zoom.

Still Camera

- **Photo Grid** - Displays a 3 x 3 grid guide on the camera viewport. Options: Disabled (default), or Enable.
- **Countdown timer** - Select Off (default), 3 seconds, or 10 seconds.

- **Picture size** - The size (in pixels) of the photo to: 16M pixels (default), 8M pixels, WVGA, VGA, QVGA.
- **Picture quality** - Set the picture quality setting to: Low, Standard, or High (default).
- **Picture Format** - All still images are saved in JPEG (default) or RAW format.
- **MFNR** - Sets multi-frame noise reduction to improve quality in low light conditions. Options: Enabled (default), or Disabled.
- **AutoFocus Animation** - Select to enable or disable the camera focus ring in the camera preview. Options: Disable (default) or Enable.

Video Camera

- **Video quality** - Set video quality to: 4k UHD (rear camera only), HD 1080p (default), HD 720p, SD 480p, VGA, CIF, or QVGA.
- **Video duration** - Set to: 30 seconds (MMS), 10 minutes, 30 minutes (default), or no limit.
- **Noise Reduction** - Off, Fast, or High Quality (default).
- **HEVC Encoder** - Save video recordings using high-efficiency video codec (HEVC/h265) for smaller file size. Options: Disabled (default), or Enable.
- **Audio Encoder** - Set the audio encoder to: AMRNB, or AAC (default).
- **Video Rotation** - Set the rotation of the video to: 0 (default), 90, 180, or 270.

System

- **Restore defaults** - Select to restore all settings to the default values.
- **About** - Displays the software version of the camera app.

DataWedge Demonstration

Use DataWedge Demonstration (DWDemo) to demonstrate data capture functionality. To configure DataWedge, refer to techdocs.zebra.com/datawedge/.



NOTE: DataWedge is enabled on the Home screen. To disable this feature, go to the DataWedge settings and disable the **Launcher** profile.

DataWedge Demonstration Icons

Table 8 DataWedge Demonstration Icons









Category	Icon	Description
Illumination		Imager illumination is on. Touch to turn illumination off.
Illumination		Imager illumination is off. Touch to turn illumination on.
Data Capture		The data capture function is through the internal imager.
Data Capture		A Bluetooth scanner is connected.

Table 8 DataWedge Demonstration Icons (Continued)

Category	Icon	Description
Data Capture		A Bluetooth scanner is not connected.
Scan Mode		Imager is in picklist mode. Touch to change to normal scan mode.
Scan Mode		Imager is in normal scan mode. Touch to change to picklist mode.
Menu		Opens a menu to view the application information or to set the application DataWedge profile.

PTT Express Voice Client

PTT Express Voice Client enables Push-To-Talk (PTT) communication between disparate enterprise devices. Leveraging existing Wireless Local Area Network (WLAN) infrastructure, PTT Express delivers simple PTT communication without requiring a voice communication server.



NOTE: The PTT Express app is available on Google Play. Use requires a PTT Express license, which can be purchased through the Zebra License Manager. Not available in all countries.

- **Group Call** - Press and hold **PTT (Talk)** to start communicating with other voice client users.
- **Private Response** - Double-press **PTT** to respond to the originator of the last broadcast or to make a Private Response.

PTT Express User Interface

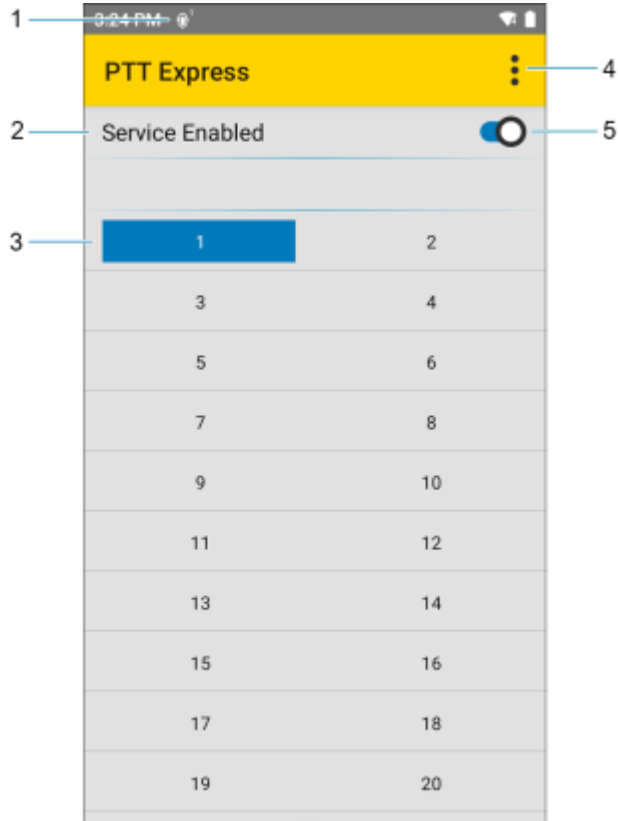

Number	Item	Description
1	Notification icon	Indicates the current state of the PTT Express client.
2	Service indication	Indicates the status of the PTT Express client. Options are: Service Enabled, Service Disabled or Service Unavailable.
3	Talk group	Lists all 32 Talk Groups available for PTT communication.
4	Settings	Opens the PTT Express Settings screen.
5	Enable/disable switch	Turns the PTT service on and off.

PTT Audible Indicators

The following tones provide helpful cues when using the voice client.







- **Talk Tone:** Double chirp. Plays when the Talk button is depressed. This is a prompt for you to start talking.
- **Access Tone:** Single beep. Plays when another user just finished a broadcast or response. You can now initiate a Group Broadcast or Private Response.
- **Busy Tone:** Continuous tone. Plays when the Talk button is depressed and another user is already communicating on the same talkgroup. Plays after the maximum allowed talk time is reached (60 seconds).

- **Network Tone:**
 - Three increasing pitch beeps. Plays when PTT Express acquires the WLAN connection and the service is enabled.
 - Three decreasing pitch beeps. Plays when PTT Express loses the WLAN connection or the service is disabled.

PTT Notification Icons

Notification icons indicate the current state of the PTT Express Voice client.

Table 9 PTT Express Icons

Status Icon	Description
	The PTT Express Voice client is disabled.
	The PTT Express Voice client is enabled but not connected to a WLAN.
	The PTT Express Voice client is enabled, connected to a WLAN, and listening on the Talk Group indicated by the number next to the icon.
	The PTT Express Voice client is enabled, connected to a WLAN, and communicating on the Talk Group indicated by the number next to the icon.
	The PTT Express Voice client is enabled, connected to a WLAN, and in a private response.
	The PTT Express Voice client is enabled and muted.
	The PTT Express Voice client is enabled but it is not able to communicate due to a VoIP telephony call in progress.

Enabling PTT Communication

1. Swipe up from the bottom of the Home screen and touch .
2. Slide the Enable/Disable Switch to the **ON** position. The button changes to **ON**.

Selecting a Talk Group

There are 32 Talk Groups that can be selected by PTT Express users. However, only one talk group can be enabled at a time on the device.

- Touch one of the 32 Talk Groups. The selected Talk Group is highlighted.

PTT Communication

This section describes the default PTT Express client configuration. Refer to the PTT Express V1.2 User Guide for detailed information on using the client.

Creating a Group Call

1. Press and hold **PTT** (or **Talk** on the headset) and listen for the talk tone.

If you hear a busy tone, release the button and wait a moment before making another attempt. Ensure that PTT Express and the WLAN are enabled.



NOTE: Holding the button for more than 60 seconds (default) drops the call, allowing others to make Group Calls. Release the button when finished talking to allow others to make calls.

2. Start talking after hearing the talk tone.
3. Release the button when finished talking.

Responding with a Private Response

The Private Response can only be initiated once a Group Call has been established. The initial Private Response is made to the originator of the Group Call.

1. Wait for an access tone.
2. Within 10 seconds, double-press **PTT**, and listen for the talk tone.
3. If you hear a busy tone, release the button and wait a moment before making another attempt. Ensure that PTT Express and the WLAN are enabled.
4. Start talking after the talk tone plays.
5. Release the button when finished talking.

Disabling PTT Communication

1. Swipe up from the bottom of the Home screen and touch .
2. Slide the **Enable/Disable Switch** to the **OFF** position. The button changes to **OFF**.

RxLogger

RxLogger is a comprehensive diagnostic tool that provides application and system metrics, and diagnoses device and application issues.

RxLogger logs the following information: CPU load, memory load, memory snapshots, battery consumption, power states, wireless logging, cellular logging, TCP dumps, Bluetooth logging, GPS logging, logcat, FTP push/pull, ANR dumps, etc. All generated logs and files are saved onto flash storage on the device (internal or external).

RxLogger Configuration

RxLogger is built with an extensible plug-in architecture and comes packaged with a number of plug-ins already built-in. For information on configuring RxLogger, refer to techdocs.zebra.com/rxlogger/.

To open the configuration screen, from the RxLogger home screen touch **Settings**.

Configuration File

All RxLogger settings are stored in a file on the device, permitting remote configuration and mass deployment of setting files using an enterprise mobile management (EMM) system.

The config.json configuration file is located in the RxLogger\config folder. Copy the file from the device to a host computer using a USB connection. Edit the configuration file and then replace the JSON file on the device. There is no need to stop and restart the RxLogger service because the file change is automatically detected.

The config.json configuration file is located on the microSD card in the RxLogger\config folder. Copy the file from the device to a host computer using a USB connection. Edit the configuration file and then replace the JSON file on the device. There is no need to stop and restart the RxLogger service because the file change is automatically detected.



IMPORTANT: The RxLogger configuration file is human-readable, but it should not be edited by hand as doing so can lead to unpredictable behavior. Zebra recommends modifying RxLogger settings only through the RxLogger UI.

- File name: config.json
- Location: /<internal_storage>/RxLogger
- With external SD Card: /storage/sdcard1/RxLogger
- With no external SD Card: /storage/sdcard0/RxLogger When a new settings file is pushed to the device, RxLogger restarts all affected modules and applies the new settings immediately.

Copy the file from the device to a host computer using a USB connection. Edit the configuration file through the RxLogger UI and then replace the JSON file on the device. There is no need to stop and restart the RxLogger service because the file change is automatically detected.

Enabling Logging

1. Swipe the screen up and select .
2. Touch **Start**.

Disabling Logging

1. Swipe the screen up and select .
2. Touch **Stop**.

Extracting Log Files

1. Connect the device to a host computer using a USB connection.
2. Using a file explorer, navigate to the RxLogger folder.
3. Copy the file from the device to the host computer.
4. Disconnect the device from the host computer.

Backing Up Data

RxLogger Utility allows the user to make a zip file of the RxLogger folder in the device, which by default contains all the RxLogger logs stored in the device.

- To save the backup data, touch  > **BackupNow**.

RxLogger Utility

RxLogger Utility is a data monitoring application for viewing logs in the device while RxLogger is running. Logs and RxLogger Utility features are accessed using Main Chat Head.

Initiating the Main Chat Head

1. Open **RxLogger**.
2. Touch  > **Toggle Chat Head**.
The Main Chat Head icon appears on the screen.
3. Touch and drag the Main Chat Head icon to move it around the screen.

Removing the Main Chat Head

1. Touch and drag the icon.
A circle with an X appears.
2. Move the icon over the circle and then release.

Viewing Logs

1. Touch the Main Chat Head icon.
The RxLogger Utility screen appears.
2. Touch a log to open it.
The user can open many logs with each displaying a new Sub Chat Head.
3. If necessary, scroll left or right to view additional Sub Chat Head icons.
4. Touch a Sub Chat Head to display the log contents.

Removing a Sub Chat Head Icon

- To remove a Sub Chat Head icon, press and hold the icon until it disappears.

Backing Up In Overlay View

RxLogger Utility allows the user to make a zip file of the RxLogger folder in the device, which by default contains all the RxLogger logs stored in the device.

The Backup icon is always available in Overlay View.

1. Touch .

The Backup dialog box appears.

2. Touch **Yes** to create the backup.

Data Capture

This section provides information for capturing barcode data using various scanning options.



NOTE: DataWedge is installed and enabled on the device by default.

The device supports data capture using:

- Internal imager (SE4770 and SE58)
- RS507/RS507X Hands-free Imager
- RS5100 Bluetooth Ring Scanner
- RS6000 Hands-free Imager
- RS6100 Hands-free Imager
- LI3678 Linear Scanner
- DS2278 Digital Scanner
- DS3678 Digital Scanner
- DS8178 Digital Scanner

By default, the good decode beep is set to system volume (Notifications). The good decode beep can be set to another sound (Music and Media), and the volume can be independently controlled.

Imaging

The device with an integrated 2D imager has the following features:

- Omnidirectional reading of a variety of barcode symbologies, including the most popular linear, postal, PDF417, Digimarc, and 2D matrix code types.
- The ability to capture and download images to a host for a variety of imaging applications.
- Advanced intuitive laser aiming cross-hair and dot aiming for easy point-and-shoot operation.

The imager uses imaging technology to take a picture of a barcode, stores the resulting image in memory, and executes state-of-the-art software decoding algorithms to extract the barcode data from the image.

Operational Modes

The device with an integrated imager supports three modes of operation.

Activate each mode by pressing **Scan**.

- Decode mode — The device attempts to locate and decode enabled barcodes within its field of view. The imager remains in this mode as long as you hold the scan button, or until it decodes a barcode.



NOTE: To enable Picklist Mode, configure in DataWedge or set in an application using an API command.

- Picklist mode — Selectively decode a barcode when more than one barcode is in the device's field of view by moving the aiming crosshair or dot over the required barcode. Use this feature for pick lists containing multiple barcodes and manufacturing or transport labels containing more than one barcode type (either 1D or 2D).



NOTE: To enable MultiBarcode Mode, configure in DataWedge or set in an application using an API command.

- MultiBarcode Mode — In this mode, the device attempts to locate and decode a specific number of unique barcodes within its field of view. The device remains in this mode as long as the user holds the scan button, or until it decodes all the barcodes.
 - The device attempts to scan the programmed number of unique barcodes (from 2 through 100). This may be a fixed amount, meaning it scans X unique barcodes, or can be set as a range to scan a different number of unique barcodes each session.
 - If there are duplicate barcodes (same symbology type and data), only one of the duplicate barcodes is decoded and the remainder are ignored. If the label has two duplicate barcodes plus another two different barcodes, a maximum of three barcodes will be decoded from that label; one will be ignored as a duplicate.
 - Barcodes can be of multiple symbology types and still be acquired together. For example, if the specified quantity for a MultiBarcode Mode scan is four, two barcodes can be symbology type Code 128 and the other two can be symbology type Code 39.
 - If the specified number of unique barcodes is not initially in view of the device, the device will not decode any data until the device is moved to capture the additional barcode(s) or time out occurs. If the device field of view contains a number of barcodes greater than the specified quantity, the device randomly decodes barcode(s) until the specified number of unique barcodes is reached. For example, if the count is set to two and eight barcodes are in the field of view, the device decodes the first two unique barcodes it sees, returning the data in random order.
 - MultiBarcode Mode does not support concatenated barcodes.

Scanning Considerations

Typically, scanning is a simple matter of aim, scan, and decode, with a few quick trial efforts to master it.

However, consider the following to optimize scanning performance:

- Range — Scanners decode optimally over a particular working range — minimum and maximum distances from the barcode. This range varies according to barcode density and scanning device optics. Scan within range for quick and constant decodes; scanning too close or too far away prevents decodes. Move the scanner closer and further away to find the right working range for the barcodes being scanned.

- Angle — Scanning angle is important for quick decodes. When the illumination/flash reflects directly back into the imager, the specular reflection can blind/saturate the imager. To avoid this, scan the barcode so that the beam does not bounce directly back. Do not scan at too sharp an angle; the scanner needs to collect scattered reflections from the scan to make a successful decode. Practice quickly shows what tolerances to work within.
- Hold the device farther away for larger symbols.
- Move the device closer for symbols with bars that are close together.



NOTE: Scanning procedures depend on the app and device configuration. An app may use different scanning procedures from the one listed above.

Scanning with the Internal Imager

To read a barcode, a scan-enabled application is required. The device contains the DataWedge application, which allows you to enable the imager, decode the barcode data, and display the barcode content.



NOTE: The SE4770 imager displays a red crosshair aimer. The SE58 displays a green crosshair aimer.

1. Ensure that an application is open on the device and a text field is in focus (text cursor in text field).
2. Point the exit window on the top of the device at a barcode or QR code.
3. Press and hold the scan button.

The device projects the aiming pattern.

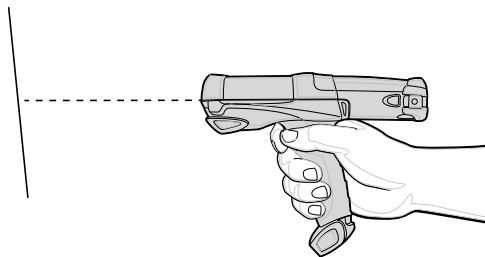

NOTE: Imager decoding usually occurs instantaneously. When the device is in Picklist mode, the imager does not decode the barcode until the red or green crosshair touches the barcode.

- Ensure that the barcode is within the area formed in the aiming pattern.

Figure 9 Aiming Patterns

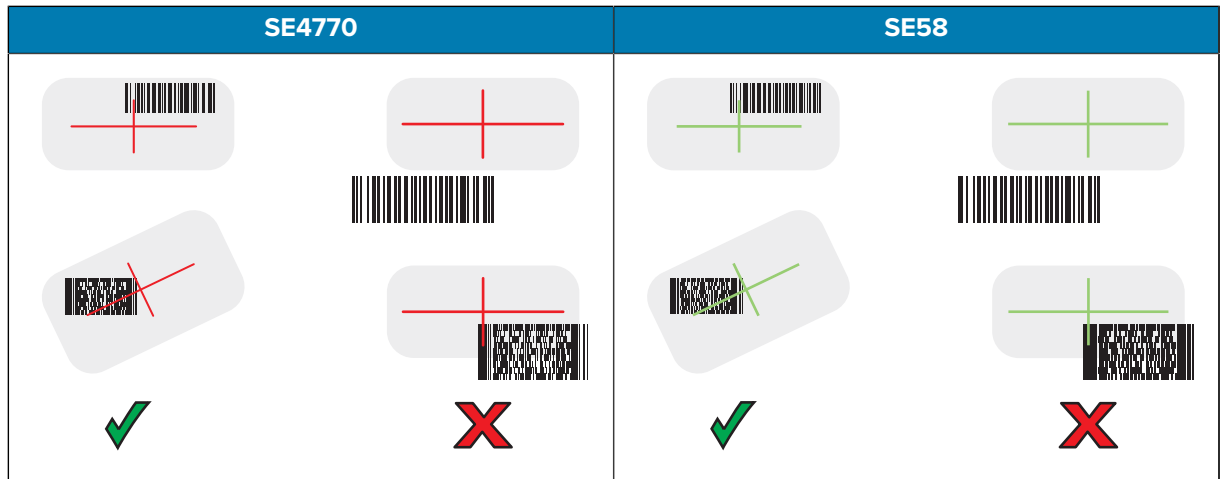
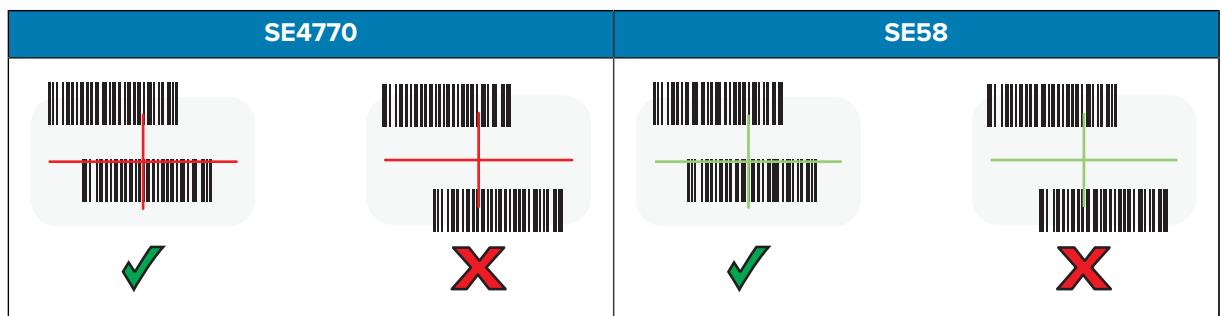

Figure 10 Picklist Mode with Multiple Barcodes in Aiming Pattern



The Data Capture LED lights green, and the device beeps, by default, to indicate that the barcode or QR code was decoded successfully.



NOTE: The device repeats the steps required to take a digital picture (image) of a poor or difficult barcode as long as the scan button remains pressed.

- Release the scan button.

The device displays the barcode or QR code data in the text field.

Pairing a Bluetooth Ring Scanner

Before using a Bluetooth Ring Scanner with the device, connect the device to the Ring Scanner.

To connect the Ring Scanner to the device, use one of the following methods:

- Near Field Communication (NFC)
- Simple Serial Interface (SSI)
- Bluetooth Human Interface Device (HID) Mode

Pairing in SSI Mode Using Near Field Communication

The device provides the ability to pair NFC-capable ring scanners (such as the RS5100, RS6000, or RS6100) in SSI Mode using NFC.

1. Ensure that NFC is enabled on the device.
2. Align the NFC icon on the Ring Scanner with the NFC antenna on the front of the device.

The Status LED blinks blue indicating that the Ring Scanner is attempting to establish a connection with the device. When a connection is established, the Status LED turns off and the Ring Scanner emits a single string of low/high beeps.

A notification appears on the device screen.

The  icon appears in the Status bar.

Pairing in HID Mode Using Near Field Communication

The device provides the ability to pair NFC-capable ring scanners (such as the RS5100, RS6000, or RS6100) in HID Mode using NFC.

1. Ensure that NFC is enabled on the device.
2. Ensure that Bluetooth is enabled on both devices.
3. Ensure that the Bluetooth device to discover is in discoverable mode.
4. Ensure that the two devices are within 10 meters (32.8 feet) of one another.
5. Place the Ring Scanner in Human Interface Device (HID) mode. If the Ring Scanner is already in HID mode, skip to step 6.
 - a) Remove the battery from the Ring Scanner.
 - b) Press and hold the Restore key.
 - c) Install the battery onto the Ring Scanner.
 - d) Keep holding the Restore key for about five seconds until a chirp is heard and the Scan LEDs flash green.
 - e) Scan the barcode below to place the Ring Scanner in HID mode.

Figure 11 Bluetooth HID Barcode

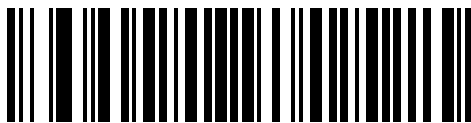

6. Remove the battery from the Ring Scanner.
7. Re-install the battery into the Ring Scanner.
8. Align the NFC icon on the Ring Scanner with the NFC antenna on the device.

The Status LED blinks blue indicating that the Ring Scanner is attempting to establish a connection with the device. When a connection is established, the Status LED turns off and the Ring Scanner emits a single string of low/high beeps.

A notification appears on the device screen.

The **A** icon appears in the Status bar.

Pairing Using Simple Serial Interface (SSI)

Pair the Ring Scanner to the device using Simple Serial Interface.

1. Swipe up from the bottom of the Home screen and touch .
2. Using the Ring Scanner, scan the barcode on the screen.

The Ring Scanner emits a string of high/low/high/low beeps. The Scan LED flashes green indicating that the Ring Scanner is attempting to establish a connection with the device. When a connection is established, the Scan LED turns off and the Ring Scanner emits one string of low/high beeps.

A notification appears on the Notification panel and the  icon appears in the Status bar.

Pairing Using Bluetooth Human Interface Device

Pair the Ring Scanner to the device using Human Interface Device (HID).

1. Ensure that Bluetooth is enabled on both devices.
2. Ensure that the Bluetooth device to discover is in discoverable mode.
3. Ensure that the two devices are within 10 meters (32.8 feet) of one another.
4. Place the Ring Scanner in HID mode. If the Ring Scanner is already in HID mode, skip to step 5.
 - a) Remove the battery from the Ring Scanner.
 - b) Press and hold **Restore**.
 - c) Install the battery onto the Ring Scanner.
 - d) Keep holding the Restore key for about five seconds until a chirp is heard and the Scan LEDs flash green.
 - e) Scan the barcode below to place the Ring Scanner in HID mode.

Figure 12 RS507 Bluetooth HID Barcode

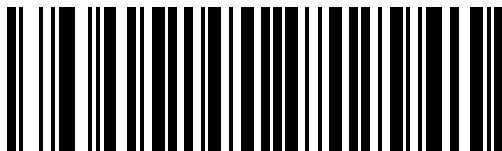
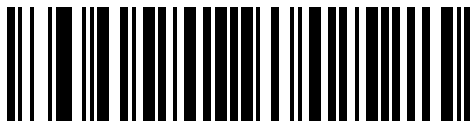



Figure 13 RS6000 Bluetooth HID Barcode



5. Remove the battery from the Ring Scanner.
6. Re-install the battery into the Ring Scanner.
7. Swipe down from the Status bar to open the Quick Access panel and then touch .
8. Touch **Bluetooth**.

9. Touch **Pair new device**. The device begins searching for discoverable Bluetooth devices in the area and displays them under **Available devices**.
10. Scroll through the list and select Ring Scanner.

The device connects to the Ring Scanner and **Connected** appears below the device name. The Bluetooth device is added to the **Paired devices** list and a trusted (“paired”) connection is established.

A notification appears on the Notification panel and the  icon appears in the Status bar.

Pairing a Bluetooth Scanner

Before using a Bluetooth scanner with the device, connect the device to the Bluetooth scanner.

Connect the scanner to the device using one of the following methods:

- Simple Serial Interface (SSI) mode
- Bluetooth Human Interface Device (HID) mode

Pairing Using Simple Serial Interface

Pair the Ring Scanner to the device using Simple Serial Interface.

1. Ensure that the two devices are within 10 meters (32.8 feet) of one another.
2. Install the battery into the scanner.
3. Swipe up from the bottom of the Home screen and touch .

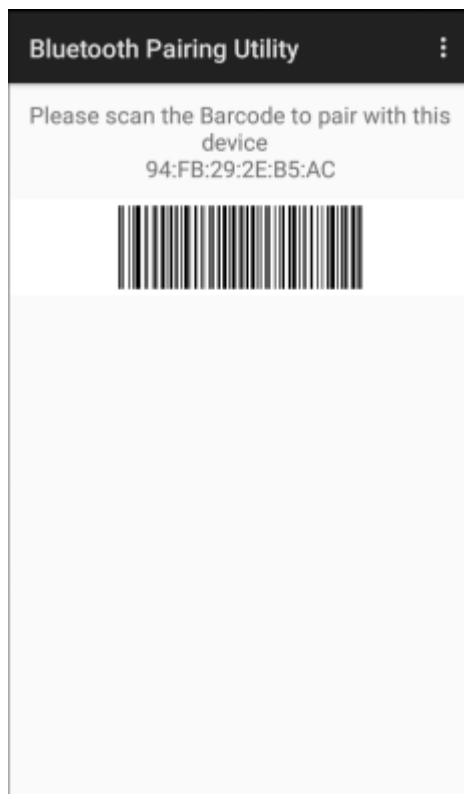

4. Using the Ring Scanner, scan the barcode on the screen.

The Ring Scanner emits a string of high/low/high/low beeps. The Scan LED flashes green indicating that the Ring Scanner is attempting to establish a connection with the device. When a connection is established, the Scan LED turns off and the Ring Scanner emits one string of low/high beeps.

A notification appears on the Notification panel and the  icon appears in the Status bar.

Pairing Using Bluetooth Human Interface Device

Pair the Bluetooth scanner to the device using HID.

To pair the scanner with the device using HID:

1. Remove the battery from the scanner.
2. Replace the battery.
3. After the scanner reboots, scan the barcode below to place the scanner in HID mode.



4. On the device, swipe down from the Status bar to open the Quick Access panel and then touch .
5. Touch **Bluetooth**.
6. Touch **Pair new device**. The device begins searching for discoverable Bluetooth devices in the area and displays them under **Available devices**.
7. Scroll through the list and select XXXXX xxxxxx, where XXXXX is the scanner and xxxxxx is the serial number.

The device connects to the scanner, the scanner beeps once and **Connected** appears below the device name. The Bluetooth device is added to the **Paired devices** list and a trusted (paired) connection is established.

DataWedge

DataWedge is a utility that adds advanced barcode scanning capability to any application without writing code. It runs in the background and handles the interface to built-in barcode scanners. The captured barcode data is converted to keystrokes and sent to the target application as if it was typed on the keypad.

DataWedge allows any app on the device to get data from input sources such as a barcode scanner, MSR, RFID, voice, or serial port and manipulate the data based on options or rules.



Configure DataWedge to:

- Provide data capture services from any app.
- Use a particular scanner, reader, or other peripheral devices.
- Properly format and transmit data to a specific app.

To configure DataWedge, refer to techdocs.zebra.com/datawedge/.

Enabling DataWedge



This procedure provides information on how to enable DataWedge on the device.

1. Swipe up from the bottom of the Home screen and touch .
2. Touch  > **Settings**.
3. Touch the **DataWedge enabled** checkbox.

A blue checkmark appears in the checkbox indicating that DataWedge is enabled.

Disabling DataWedge

This procedure provides information on how to disable DataWedge on the device.

1. Swipe up from the bottom of the Home screen and touch .
2. Touch .
3. Touch **Settings**.
4. Touch **DataWedge enabled**.

Supported Decoders

This sections provides the supported decoders for each data capture option.

Camera Supported Decoders

Lists the supported decoders for the internal camera.

Table 10 Camera Supported Decoders

Decoder	Default State	Decoder	Default State	Decoder	Default State
Australian Postal	O	EAN8	X	MSI	O
Aztec	X	Grid Matrix	O	PDF417	X
Canadian Postal	O	GS1 DataBar	X	QR Code	X
Chinese 2 of 5	O	GS1 DataBar Expanded	X	Decoder Signature	O
Codabar	X	GS1 DataBar Limited	O	TLC 39	O
Code 11	O	GS1 Datamatrix	O	Trioptic 39	O
Code 128	X	GS1 QRCode	O	UK Postal	O
Code 39	X	HAN XIN	O	UPCA	X
Code 93	O	Interleaved 2 of 5	O	UPCE0	X
Composite AB	O	Japanese Postal	O	UPCE1	O

Table 10 Camera Supported Decoders (Continued)

Decoder	Default State	Decoder	Default State	Decoder	Default State
Composite C	O	Korean 3 of 5	O	US4state	O
Discrete 2 of 5	O	MAIL MARK	X	US4state FICS	O
Datamatrix	X	Matrix 2 of 5	O	US Planet	O
Dutch Postal	O	Maxicode	X	US Postnet	O
DotCode	X	MicroPDF	O		
EAN13	X	MicroQR	O		

Key: X = Enabled, O = Disabled, - = Not Supported

SE4770 Internal Imager Supported Decoders

Lists the supported decoders for the SE4770 internal imager.

Table 11 SE4770 Internal Imager Supported Decoders

Decoder	Default State	Decoder	Default State	Decoder	Default State
Australian Postal	O	EAN8	X	MSI	O
Aztec	X	Grid Matrix	O	PDF417	X
Canadian Postal	O	GS1 DataBar	X	QR Code	X
Chinese 2 of 5	O	GS1 DataBar Expanded	X	Decoder Signature	O
Codabar	X	GS1 DataBar Limited	O	TLC 39	O
Code 11	O	GS1 Datamatrix	O	Trioptic 39	O
Code 128	X	GS1 QRCode	O	UK Postal	O
Code 39	X	HAN XIN	O	UPCA	X
Code 93	O	Interleaved 2 of 5	O	UPCE0	X
Composite AB	O	Japanese Postal	O	UPCE1	O
Composite C	O	Korean 3 of 5	O	US4state	O
Discrete 2 of 5	O	MAIL MARK	X	US4state FICS	O
Datamatrix	X	Matrix 2 of 5	O	US Planet	O
Dutch Postal	O	Maxicode	X	US Postnet	O
DotCode	O	MicroPDF	O		
EAN13	X	MicroQR	O		

Key: X = Enabled, O = Disabled, - = Not Supported

SE58 Internal Imager Supported Decoders

Lists the supported decoders for the SE58 internal imager.

Table 12 SE58 Internal Imager Supported Decoders

Decoder	Default State	Decoder	Default State	Decoder	Default State
Australian Postal	X	EAN8	X	MSI	O
Aztec	X	Grid Matrix	O	PDF417	X
Canadian Postal	O	GS1 DataBar	X	QR Code	X
Chinese 2 of 5	O	GS1 DataBar Expanded	X	Decoder Signature	O
Codabar	O	GS1 DataBar Limited	X	TLC 39	O
Code 11	O	GS1 Datamatrix	O	Trioptic 39	O
Code 128	X	GS1 QRCode	O	UK Postal	X
Code 39	X	HAN XIN	O	UPCA	X
Code 93	O	Interleaved 2 of 5	O	UPCE0	X
Composite AB	O	Japanese Postal	X	UPCE1	X
Composite C	O	Korean 3 of 5	O	US4state	O
Discrete 2 of 5	O	MAIL MARK	O	US4state FICS	O
Datamatrix	X	Matrix 2 of 5	O	US Planet	O
Dutch Postal	O	Maxicode	X	US Postnet	O
DotCode	O	MicroPDF	O		
EAN13	X	MicroQR	X		

Key: X = Enabled, O = Disabled, - = Not Supported

LI3678 Supported Decoders

Lists the supported decoders for the LI3678 scanner.

Table 13 LI3678 Supported Decoders

Decoder	Default State	Decoder	Default State	Decoder	Default State
Australian Postal	—	EAN8	X	MSI	O
Aztec	—	Grid Matrix	O	PDF417	—
Canadian Postal	—	GS1 DataBar	X	QR Code	—

Table 13 LI3678 Supported Decoders (Continued)

Decoder	Default State	Decoder	Default State	Decoder	Default State
Chinese 2 of 5	O	GS1 DataBar Expanded	X	Decoder Signature	—
Codabar	X	GS1 DataBar Limited	O	TLC 39	O
Code 11	O	GS1 Datamatrix	—	Trioptic 39	O
Code 128	X	GS1 QRCode	—	UK Postal	—
Code 39	X	HAN XIN	O	UPCA	X
Code 93	O	Interleaved 2 of 5	O	UPCE0	X
Composite AB	—	Japanese Postal	—	UPCE1	O
Composite C	—	Korean 3 of 5	O	US4state	—
Discrete 2 of 5	O	MAIL MARK	—	US4state FICS	—
Datamatrix	—	Matrix 2 of 5	O	US Planet	—
Dutch Postal	—	Maxicode	—	US Postnet	—
DotCode	O	MicroPDF	—		
EAN13	X	MicroQR	—		

Key: X = Enabled, O = Disabled, — = Not Supported

DS2278 Supported Decoders

Lists the supported decoders for the DS2278 Digital Scanner.

Table 14 DS2278 Digital Scanner Supported Decoders

Decoder	Default State	Decoder	Default State	Decoder	Default State
Australian Postal	O	EAN8	X	MSI	O
Aztec	X	Grid Matrix	O	PDF417	X
Canadian Postal	—	GS1 DataBar	X	QR Code	X
Chinese 2 of 5	O	GS1 DataBar Expanded	X	Decoder Signature	O
Codabar	X	GS1 DataBar Limited	O	TLC 39	O
Code 11	O	GS1 Datamatrix	O	Trioptic 39	O
Code 128	X	GS1 QRCode	O	UK Postal	O
Code 39	X	HAN XIN	—	UPCA	X

Table 14 DS2278 Digital Scanner Supported Decoders (Continued)

Decoder	Default State	Decoder	Default State	Decoder	Default State
Code 93	O	Interleaved 2 of 5	O	UPCE0	X
Composite AB	O	Japanese Postal	O	UPCE1	O
Composite C	O	Korean 3 of 5	O	US4state	O
Discrete 2 of 5	O	MAIL MARK	X	US4state FICS	O
Datamatrix	X	Matrix 2 of 5	O	US Planet	O
Dutch Postal	O	Maxicode	X	US Postnet	O
DotCode	O	MicroPDF	O		
EAN13	X	MicroQR	O		

Key: X = Enabled, O = Disabled, — = Not Supported

DS3678 Supported Decoders

Lists the supported decoders for the DS3678 scanner.

Table 15 DS3678 Supported Decoders

Decoder	Default State	Decoder	Default State	Decoder	Default State
Australian Postal	O	EAN8	X	MSI	O
Aztec	X	Grid Matrix	O	PDF417	X
Canadian Postal	—	GS1 DataBar	X	QR Code	X
Chinese 2 of 5	O	GS1 DataBar Expanded	X	Decoder Signature	—
Codabar	X	GS1 DataBar Limited	O	TLC 39	O
Code 11	O	GS1 Datamatrix	O	Trioptic 39	O
Code 128	X	GS1 QRCode	O	UK Postal	O
Code 39	X	HAN XIN	O	UPCA	X
Code 93	O	Interleaved 2 of 5	O	UPCE0	X
Composite AB	O	Japanese Postal	O	UPCE1	O
Composite C	O	Korean 3 of 5	O	US4state	O
Discrete 2 of 5	O	MAIL MARK	X	US4state FICS	O
Datamatrix	X	Matrix 2 of 5	O	US Planet	O
Dutch Postal	O	Maxicode	X	US Postnet	O

Table 15 DS3678 Supported Decoders (Continued)

Decoder	Default State	Decoder	Default State	Decoder	Default State
DotCode	O	MicroPDF	O		
EAN13	X	MicroQR	O		

Key: X = Enabled, O = Disabled, — = Not Supported

DS8178 Supported Decoders

Lists the supported decoders for the DS8178 Digital scanner.

Table 16 DS8178 Digital Scanner Supported Decoders

Decoder	Default State	Decoder	Default State	Decoder	Default State
Australian Postal	O	EAN8	X	MSI	O
Aztec	X	Grid Matrix	O	PDF417	X
Canadian Postal	—	GS1 DataBar	X	QR Code	X
Chinese 2 of 5	O	GS1 DataBar Expanded	X	Decoder Signature	—
Codabar	X	GS1 DataBar Limited	O	TLC 39	O
Code 11	O	GS1 Datamatrix	O	Trioptic 39	O
Code 128	X	GS1 QRCode	O	UK Postal	O
Code 39	X	HAN XIN	—	UPCA	X
Code 93	O	Interleaved 2 of 5	O	UPCE0	X
Composite AB	O	Japanese Postal	O	UPCE1	O
Composite C	O	Korean 3 of 5	O	US4state	O
Discrete 2 of 5	O	MAIL MARK	X	US4state FICS	O
Datamatrix	X	Matrix 2 of 5	O	US Planet	O
Dutch Postal	O	Maxicode	X	US Postnet	O
DotCode	O	MicroPDF	O		
EAN13	X	MicroQR	O		

Key: X = Enabled, O = Disabled, — = Not Supported

RS507/RS507x Supported Decoders

Lists the supported decoders for the RS507/RS507x Ring Scanner.

Table 17 RS507/RS507x Supported Decoders

Decoder	Default State	Decoder	Default State	Decoder	Default State
Australian Postal	O	EAN8	X	MSI	O
Aztec	X	Grid Matrix	O	PDF417	X
Canadian Postal	-	GS1 DataBar	X	QR Code	X
Chinese 2 of 5	O	GS1 DataBar Expanded	X	Decoder Signature	O
Codabar	X	GS1 DataBar Limited	O	TLC 39	O
Code 11	O	GS1 Datamatrix	-	Trioptic 39	O
Code 128	X	GS1 QRCode	-	UK Postal	O
Code 39	O	HAN XIN	-	UPCA	X
Code 93	O	Interleaved 2 of 5	O	UPCE0	X
Composite AB	O	Japanese Postal	O	UPCE1	O
Composite C	O	Korean 3 of 5	O	US4state	O
Discrete 2 of 5	O	MAIL MARK	-	US4state FICS	O
Datamatrix	X	Matrix 2 of 5	O	US Planet	O
Dutch Postal	O	Maxicode	X	US Postnet	O
DotCode	O	MicroPDF	O		
EAN13	X	MicroQR	O		

Key: X = Enabled, O = Disabled, - = Not Supported

RS5100 Supported Decoders

Lists the supported decoders for the RS5100 Ring Scanner.

Table 18 RS5100 Supported Decoders

Decoder	Default State	Decoder	Default State	Decoder	Default State
Australian Postal	O	EAN8	X	MSI	O
Aztec	X	Grid Matrix	O	PDF417	X
Canadian Postal	O	GS1 DataBar	X	QR Code	X

Table 18 RS5100 Supported Decoders (Continued)

Decoder	Default State	Decoder	Default State	Decoder	Default State
Chinese 2 of 5	O	GS1 DataBar Expanded	X	Decoder Signature	O
Codabar	X	GS1 DataBar Limited	O	TLC 39	O
Code 11	O	GS1 Datamatrix	O	Trioptic 39	O
Code 128	X	GS1 QRCode	O	UK Postal	O
Code 39	X	HAN XIN	O	UPCA	X
Code 93	O	Interleaved 2 of 5	O	UPCE0	X
Composite AB	O	Japanese Postal	O	UPCE1	O
Composite C	O	Korean 3 of 5	O	US4state	O
Discrete 2 of 5	O	MAIL MARK	X	US4state FICS	O
Datamatrix	X	Matrix 2 of 5	O	US Planet	O
Dutch Postal	O	Maxicode	X	US Postnet	O
DotCode	O	MicroPDF	O		
EAN13	X	MicroQR	O		

Key: X = Enabled, O = Disabled, - = Not Supported

RS6000 Supported Decoders

Lists the supported decoders for the RS6000 Ring Scanner.

Table 19 RS6000 Supported Decoders

Decoder	Default State	Decoder	Default State	Decoder	Default State
Australian Postal	O	EAN8	X	MSI	O
Aztec	X	Grid Matrix	O	PDF417	X
Canadian Postal	O	GS1 DataBar	X	QR Code	X
Chinese 2 of 5	O	GS1 DataBar Expanded	X	Decoder Signature	O
Codabar	X	GS1 DataBar Limited	O	TLC 39	O
Code 11	O	GS1 Datamatrix	O	Trioptic 39	O
Code 128	X	GS1 QRCode	O	UK Postal	O
Code 39	X	HAN XIN	O	UPCA	X

Table 19 RS6000 Supported Decoders (Continued)

Decoder	Default State	Decoder	Default State	Decoder	Default State
Code 93	O	Interleaved 2 of 5	O	UPCE0	X
Composite AB	O	Japanese Postal	O	UPCE1	O
Composite C	O	Korean 3 of 5	O	US4state	O
Discrete 2 of 5	O	MAIL MARK	X	US4state FICS	O
Datamatrix	X	Matrix 2 of 5	O	US Planet	O
Dutch Postal	O	Maxicode	X	US Postnet	O
DotCode	O	MicroPDF	O		
EAN13	X	MicroQR	O		

Key: X = Enabled, O = Disabled, - = Not Supported

RS6100 Supported Decoders

Lists the supported decoders for the RS6100 Ring Scanner.

Table 20 RS6100 Supported Decoders

Decoder	Default State	Decoder	Default State	Decoder	Default State
Australian Postal	O	EAN8	X	MSI	O
Aztec	X	Grid Matrix	O	PDF417	X
Canadian Postal	O	GS1 DataBar	X	QR Code	X
Chinese 2 of 5	O	GS1 DataBar Expanded	X	Decoder Signature	O
Codabar	X	GS1 DataBar Limited	O	TLC 39	O
Code 11	O	GS1 Datamatrix	O	Trioptic 39	O
Code 128	X	GS1 QRCode	O	UK Postal	O
Code 39	X	HAN XIN	O	UPCA	X
Code 93	O	Interleaved 2 of 5	O	UPCE0	X
Composite AB	O	Japanese Postal	O	UPCE1	O
Composite C	O	Korean 3 of 5	O	US4state	O
Discrete 2 of 5	O	MAIL MARK	X	US4state FICS	O
Datamatrix	X	Matrix 2 of 5	O	US Planet	O
Dutch Postal	O	Maxicode	X	US Postnet	O

Table 20 RS6100 Supported Decoders (Continued)

Decoder	Default State	Decoder	Default State	Decoder	Default State
DotCode	O	MicroPDF	O		
EAN13	X	MicroQR	O		

Key: X = Enabled, O = Disabled, - = Not Supported

Wireless

This section provides information on the wireless features of the device.

- Wireless Local Area Network (WLAN)
- Wireless Wide Area Network (WWAN)
- Bluetooth
- Cast
- Near Field Communications (NFC)

Wireless Local Area Networks

Wireless local area networks (WLANs) allow the device to communicate wirelessly inside a building. Before using the device on a WLAN, the facility must be set up with the required hardware to run the WLAN (sometimes known as infrastructure). The infrastructure and the device must both be properly configured to enable this communication.



NOTE: To extend the life of the battery, turn off Wi-Fi when not in use.

The **Status** bar displays icons that indicate Wi-Fi network availability and Wi-Fi status.

Refer to the documentation provided with the infrastructure (access points (APs), access ports, switches, Radius servers, and so on) for instructions on how to set up the infrastructure.

After the infrastructure is set up to enforce the chosen WLAN security scheme, use the **Network & internet** settings to configure the device to match the security scheme.

- None
- Enhanced Open
- Wireless Equivalent Privacy (WEP)
- Wi-Fi Protected Access (WPA)/WPA2 Personal (PSK)
- WPA3-Personal
- WPA/WPA2-Enterprise
- WPA3-Enterprise
- WPA3-Enterprise 192-bit

Connecting to a Wi-Fi Network

Connect to a nearby Wi-Fi network.

1. Go to **Settings**.

2. Touch **Network & internet > Internet**.

The device searches for WLANs in the area and lists them.

3. Scroll through the list and select the desired WLAN network.

- For open networks, touch the profile once, or press and hold the profile and then select **Connect**.
- For secure networks, touch the profile, enter the required password or other credentials, and then touch **Connect**. See the system administrator for more information.

The device obtains a network address and other required information from the network using the dynamic host configuration protocol (DHCP) protocol. To configure the device with a fixed internet protocol (IP) address, see [Configuring the Device to Use a Static IP Address](#) on page 94.

4. In the Wi-Fi setting field, **Connected** appears indicating that the device is connected to the WLAN.

Removing a Wi-Fi Network

Remove a remembered or connected Wi-Fi network.

1. Go to **Settings**.

2. Touch **Network & internet > Internet**.

The device searches for WLANs in the area and lists them.

3. Scroll down to the bottom of the list and touch **Saved networks**.

4. Touch the name of the network.

5. Touch **FORGET**.

WLAN Configuration

This section provides information on configuring Wi-Fi settings.

Configuring a Secure Wi-Fi Network

1. Go to **Settings**.

2. Touch **Network & internet > Internet**.

The device searches for WLANs in the area and lists them.

3. Slide the Wi-Fi switch to the **ON** position.

4. Scroll through the list and select the desired WLAN network.

5. Touch the desired network. If network security is **Open**, the device automatically connects to the network. For all other network security, a dialog box appears.

6. If network security is:

WPA/WPA2-Personal	Enter the required password and then touch Connect .
--------------------------	---

<p>WPA3-Personal</p> <p>WEP</p>	
<p>WPA/WPA2/WPA3 Enterprise</p>	<p>a. Touch the EAP method drop-down list and select one of the following:</p> <ul style="list-style-type: none"> • PEAP • TLS • TTLS • PWD • LEAP <p>b. Fill in the appropriate information. Options vary depending on the EAP method chosen.</p> <ul style="list-style-type: none"> • When selecting CA certificate, Certification Authority (CA) certificates are installed using the Security settings. • When using the EAP methods PEAP, TLS, or TTLS, specify a domain. • Touch Advanced options to display additional network options.
<p>WPA3-Enterprise 192-bit</p>	<p>a. Touch CA certificate and select a Certification Authority (CA) certificate. Note: Certificates are installed using the Security settings.</p> <p>b. Touch User certificate and select a user certificate. Note: User certificates are installed using the Security settings.</p> <p>c. In the Identity text box, enter the username credentials.</p>



NOTE: By default, the network Proxy is set to None and the IP settings is set to DHCP. See [Configuring for a Proxy Server](#) on page 94 for setting the connection to a proxy server and see [Configuring the Device to Use a Static IP Address](#) on page 94 for setting the device to use a static IP address.

7. Touch **Connect**.

Manually Adding a Wi-Fi Network

Manually add a Wi-Fi network if the network does not broadcast its name (SSID) or add a Wi-Fi network when out of range.

1. Go to **Settings**.
2. Touch **Network & internet > Internet**.
3. Slide the Wi-Fi switch to the **On** position.
4. Scroll to the bottom of the list and select **Add network**.
5. In the **Network name** text box, enter the name of the Wi-Fi network.

6. In the **Security** drop-down list, set the type of security to:

- **None**
- **Enhanced Open**
- **WEP**
- **WPA/WPA2-Personal**
- **WPA3-Personal**
- **WPA/WPA2/WPA3-Enterprise**
- **WPA3-Enterprise 192-bit**

7. If the network security is:

<p>None Enhanced Open</p>	<p>Touch Save.</p>
<p>WEP WPA2-Personal WPA/WPA3-Personal</p>	<p>Enter the required password and then touch Save.</p>
<p>WPA/WPA2/WPA3 Enterprise</p>	<p>a. Touch the EAP method drop-down list and select one of the following:</p> <ul style="list-style-type: none"> • PEAP • TLS • TTLS • PWD • LEAP <p>b. Fill in the appropriate information. Options vary depending on the EAP method chosen.</p> <ul style="list-style-type: none"> • When selecting CA certificate, Certification Authority (CA) certificates are installed using the Security settings. • When using the EAP methods PEAP, TLS, or TTLS, specify a domain. • Touch Advanced options to display additional network options.
<p>WPA3-Enterprise 192-bit</p>	<p>a. Touch CA certificate and select a Certification Authority (CA) certificate. Note: Certificates are installed using the Security settings.</p> <p>b. Touch User certificate and select a user certificate. Note: User certificates are installed using the Security settings.</p>

c. In the **Identity** text box, enter the username credentials.



NOTE: By default, the network Proxy is set to None and the IP settings is set to DHCP. See [Configuring for a Proxy Server](#) on page 94 for setting the connection to a proxy server and see [Configuring the Device to Use a Static IP Address](#) on page 94 for setting the device to use a static IP address.

8. Touch **Save**. To connect to the saved network, touch and hold on the saved network and select **Connect to network**.

Configuring for a Proxy Server

A proxy server is a server that acts as an intermediary for requests from clients seeking resources from other servers. A client connects to the proxy server and requests some service, such as a file, connection, web page, or other resource, available from a different server. The proxy server evaluates the request according to its filtering rules. For example, it may filter traffic by IP address or protocol. If the request is validated by the filter, the proxy provides the resource by connecting to the relevant server and requesting the service on behalf of the client.

It is important for enterprise customers to be able to set up secure computing environments within their companies, making proxy configuration essential. Proxy configuration acts as a security barrier ensuring that the proxy server monitors all traffic between the Internet and the intranet. This is normally an integral part of security enforcement in corporate firewalls within intranets.

1. Go to **Settings**.
2. Touch **Network & internet > Internet**.
3. Slide the Wi-Fi switch to the **On** position.
4. In the network dialog box, select and touch a network.
5. If configuring the connected network, touch  to edit the network details and then touch the down arrow to hide the keyboard.
6. Touch **Advanced options**.
7. Touch **Proxy** and select **Manual**.
8. In the **Proxy hostname** text box, enter the address of the proxy server.
9. In the **Proxy port** text box, enter the port number for the proxy server.
10. In the **Bypass proxy for** text box, enter addresses for web sites that are not required to go through the proxy server. Use a comma “,” between addresses. Do not use spaces or carriage returns between addresses.
11. If configuring the connected network, touch **Save** otherwise, touch **Connect**.
12. Touch **Connect**.

Configuring the Device to Use a Static IP Address

By default, the device is configured to use Dynamic Host Configuration Protocol (DHCP) to assign an Internet protocol (IP) address when connecting to a wireless network.

1. Go to **Settings**.
2. Touch **Network & internet > Internet**.
3. Slide the Wi-Fi switch to the **On** position.

4. In the network dialog box, select and touch a network.
5. If configuring the connected network, touch  to edit the network details and then touch the down arrow to hide the keyboard.
6. Touch **Advanced options**.
7. Touch **IP settings** and select **Static**.
8. In the **IP address** text box, enter an IP address for the device.
9. If required, in the **Gateway** text box, enter a gateway address for the device.
10. If required, in the **Network prefix length** text box, enter the prefix length.
11. If required, in the **DNS 1** text box, enter a Domain Name System (DNS) address.
12. If required, in the **DNS 2** text box, enter a DNS address.
13. If just configuring the connected network, touch **Save**. Otherwise, touch **Connect**.

Wi-Fi Preferences

Use the Wi-Fi preferences to configure advanced Wi-Fi settings. From **Network & internet > Internet**, scroll down to the bottom of the screen and then touch **Network preferences**.

- **Turn on Wi-Fi automatically** - When enabled, Wi-Fi automatically turns back on when near high-quality saved networks.
- **Notify for public network** - When enabled, notifies the user when an open network is available.
- **Additional settings** - Touch to view additional Wi-Fi settings.
- **Install Certificates** – Touch to install certificates.
- **Wi-Fi Direct** - Displays a list of devices available for a direct Wi-Fi connection.

Additional Wi-Fi Settings

Use the Additional Settings option to configure detailed Wi-Fi settings. From **Network & internet > Internet**, scroll down to the bottom of the screen and then touch **Network preferences > Additional Settings**.



NOTE: Additional Wi-Fi settings are for the device, not for a specific wireless network.

- **Regulatory**
 - **Country Selection** - Displays the acquired country code if 802.11d is enabled, else it displays the currently selected country code.
 - **Region code** - Displays the current region code.

- **Band and Channel Selection**
 - **Wi-Fi frequency band** - Set the frequency band to: **Auto** (default), **6 GHz only**, **5 GHz only** or **2.4 GHz only**.
 - **Available channels (2.4 GHz)** - Touch to display the **Available channels** menu. Select specific channels and touch **OK**.
 - **Available channels (5 GHz)** - Touch to display the **Available channels** menu. Select specific channels and touch **OK**.
 - **Available channels (6 GHz)** - Touch to display the **Available channels** menu. Select specific channels and touch **OK**.
- **Logging**
 - **Advanced Logging** – Touch to enable advanced logging or change the log directory.
 - **Wireless logs** Wireless logs - Use to capture Wi-Fi log files.
 - **Fusion Logger** - Touch to open the **Fusion Logger** application. This application maintains a history of high level WLAN events which helps to understand the status of connectivity.
 - **Fusion Status** - Touch to display live status of WLAN state. Also provides information about the device and connected profile.
- **About**
 - **Version** - Displays the current version information. Touch the version to display additional version details.

Wi-Fi Direct

Wi-Fi Direct devices can connect to each other without having to go through an access point. Wi-Fi Direct devices establish their own ad-hoc network when required, letting you see which devices are available and choose which one you want to connect to.

1. Go to **Settings**.
2. Touch **Network & internet > Internet** .
3. Slide the **Wi-Fi** switch to the **On** position.
4. In the network dialog box, select and touch a network.
5. Scroll to the bottom of the screen and touch **Network preferences > Wi-Fi Direct**.

The device begins searching for another Wi-Fi Direct device.

Wireless Wide Area Networks

Use Wireless wide area networks (WWANs) to access data over a cellular network.

This section provides information on:

- Sharing a data connection
- Monitoring data usage
- Changing Cellular Network settings

Sharing the Mobile Data Connection

The **Tethering & Portable Hotspot** settings allow sharing the mobile data connection with a single computer via USB tethering or Bluetooth tethering.

Share the data connection with up to eight devices at once, by turning it into a portable Wi-Fi hotspot. While the device is sharing its data connection, an icon displays at the top of the screen and a corresponding message appears in the notification list.

Enabling Bluetooth Tethering

Use Bluetooth tethering to share the data connection with a host computer.

Configure the host computer to obtain its network connection using Bluetooth. For more information, see the host computer's documentation.

1. Pair the device with the host computer.
2. Go to **Settings**.
3. Touch **Networking & internet > Hotspot & tethering**
4. Touch the **Bluetooth tethering** switch to enable.

The host computer is now sharing the device's data connection.

To stop sharing the data connection, touch the **Bluetooth tethering** switch again.

Configuring the Wi-Fi Hotspot

1. Go to **Settings**.
2. Touch **Network & internet**.
3. Touch **Hotspot & tethering**.
4. Touch **Wi-Fi hotspot**.
5. In the **Hotspot name** text field, edit the name for the hotspot.
6. Touch **OK**.
7. Touch **Security** and select a security method from the drop-down list.
 - **WPA3-Personal**
 - **WPA2/WPA3-Personal**
 - **WPA2-Personal**
 - **None** - If **None** is selected in the Security option, a password is not required.
8. Touch **Hotspot password**.
9. Enter a password.
10. Touch **OK**.
11. If desired, touch **Turn off hotspot automatically** to turn off Wi-Fi Hotspot when no devices are connected.
12. Select **Additional Settings** to configure the Hotspot channel for the chosen band, maximum clients, and connected devices.

Enabling the Wi-Fi Hotspot

After configuring the device as a Wi-Fi Hotspot, turn on **Wi-Fi hotspot** to begin using it.

1. Go to **Settings**.
2. Touch **Networking & internet**.
3. Touch **Hotspot & tethering**.
4. Touch **Wi-Fi hotspot**.
5. Toggle the switch to enable.

After a moment, the device starts broadcasting its Wi-Fi network name (SSID). Connect to it with up to eight computers or other devices. The Hotspot  icon appears in the Status bar.

To stop sharing the data connection, touch the toggle switch again.

Data Usage

Data usage refers to the amount of data uploaded or downloaded by the device during a given period. Depending on the wireless plan, you may be charged additional fees when your data usage exceeds your plan's limit.

Data usage settings allow you to:

- Enable Data Saver.
- Set the data usage warning level.
- Set a data usage limit.
- View or restrict data usage by app.
- Identify mobile hotspots and restrict background downloads that may result in extra charges.

Setting Data Usage Warning

Set a warning alert when the device has used a certain amount of mobile data.

1. Go to **Settings**.
2. Touch **Network & internet > Mobile network > Data usage > **.
3. If necessary, touch **Set data warning** to enable it.
4. Touch **Data warning**.
5. Enter a number.

To switch between megabytes (MB) and gigabytes (GB), touch the down arrow.

6. Touch **SET**.

When the data usage reaches the set level, a notification appears.

Setting Data Limit

1. Go to **Settings**.
2. Touch **Network & internet > Mobile network > Data usage > **.
3. Touch **Set data limit**.

4. Touch **OK**.

5. Touch **Data limit**.

6. Enter a number.

To switch between megabytes (MB) and gigabytes (GB), touch the down arrow.

7. Touch **Set**.

When the limit is reached, data automatically turns off and a notification appears.

Cellular Network Settings

Cellular network settings applies to WWAN devices only.

Data When Roaming

Roaming is disabled by default to prevent the device from transmitting data over other carriers' mobile networks when leaving an area that is covered by the carrier's networks. This is useful for controlling expenses if the service plan does not include data roaming.

Enabling Data on GSM Devices

1. Go to **Settings**.

2. Touch **Networking & Internet > Mobile network**.

3. Touch **Roaming**.

The switch moves to the on position.

Setting Preferred Network

Change the network operating mode.

1. Go to **Settings**.

2. Touch **Network & Internet > Mobile network > Advanced**.

3. Touch **Automatically select network**.

4. Touch **Network**.

5. In the **Available network** list, select a carrier network.

Configuring the Access Point Name

To use the data on a network, configure the APN information.



NOTE: Many service provider Access Point Name (APN) data are pre-configured in the device. The APN information for all other service providers must be obtained from the wireless service provider.

1. Go to **Settings**.

2. Touch **Network & Internet > Mobile network > Advanced**.

3. Touch **Access Point Names**.

4. Touch an APN name in the list to edit an existing APN or touch + to create a new APN.

5. Touch each APN setting and enter the appropriate data obtained from the wireless service provider.
6. When finished, touch  > **Save**.
7. Touch the radio button next to the APN name to start using it.

Locking the SIM Card

Locking the SIM card requires the user to enter a PIN every time the device is turned on. If the correct PIN is not entered, only emergency calls can be made.

1. Go to **Settings**.
2. Touch **Security** > **SIM card lock**.
3. Touch **Lock SIM card**.
4. Enter the PIN associated with the card.
5. Touch **OK**.
6. Reset the device.

Bluetooth

Bluetooth devices can communicate without wires, using frequency-hopping spread spectrum (FHSS) radio frequency (RF) to transmit and receive data in the 2.4 GHz Industry Scientific and Medical (ISM) band (802.15.1). Bluetooth wireless technology is specifically designed for short-range (10 m (32.8 ft)) communication and low power consumption.

Devices with Bluetooth capabilities can exchange information (for example, files, appointments, and tasks) with other Bluetooth enabled devices such as printers, access points, and other mobile devices.

The device supports Bluetooth Low Energy. Bluetooth Low Energy is targeted at applications in the healthcare, fitness, security, and home entertainment industries. It provides reduced power consumption and cost while maintaining standard Bluetooth range.

Adaptive Frequency Hopping

Adaptive Frequency Hopping (AFH) is a method of avoiding fixed frequency interferers, and can be used with Bluetooth voice. All devices in the piconet (Bluetooth network) must be AFH-capable in order for AFH to work. There is no AFH when connecting and discovering devices. Avoid making Bluetooth connections and discoveries during critical 802.11b communications.

AFH for Bluetooth consists of four main sections:

- Channel Classification - A method of detecting an interference on a channel-by-channel basis, or pre-defined channel mask.
- Link Management - Coordinates and distributes the AFH information to the rest of the Bluetooth network.
- Hop Sequence Modification - Avoids interference by selectively reducing the number of hopping channels.
- Channel Maintenance - A method for periodically re-evaluating the channels.

When AFH is enabled, the Bluetooth radio “hops around” (instead of through) the 802.11b high-rate channels. AFH coexistence allows enterprise devices to operate in any infrastructure.

The Bluetooth radio in this device operates as a Class 2 device power class. The maximum output power is 2.5 mW and the expected range is 10 m (32.8 ft). A definition of ranges based on power class is difficult to obtain due to power and device differences, and whether in open space or closed office space.



NOTE: It is not recommended to perform Bluetooth wireless technology inquiry when high rate 802.11b operation is required.

Security

The current Bluetooth specification defines security at the link level. Application-level security is not specified. This allows application developers to define security mechanisms tailored to their specific need. Link-level security occurs between devices, not users, while application-level security can be implemented on a per-user basis. The Bluetooth specification defines security algorithms and procedures required to authenticate devices, and if needed, encrypt the data flowing on the link between the devices. Device authentication is a mandatory feature of Bluetooth while link encryption is optional.

Pairing of Bluetooth devices is accomplished by creating an initialization key used to authenticate the devices and create a link key for them. Entering a common personal identification number (PIN) in the devices being paired generates the initialization key. The PIN is never sent over the air. By default, the Bluetooth stack responds with no key when a key is requested (it is up to user to respond to the key request event). Authentication of Bluetooth devices is based-upon a challenge-response transaction. Bluetooth allows for a PIN or passkey used to create other 128-bit keys used for security and encryption. The encryption key is derived from the link key used to authenticate the pairing devices. Also worthy of note is the limited range and fast frequency hopping of the Bluetooth radios that makes long-distance eavesdropping difficult.

Recommendations are:

- Perform pairing in a secure environment.
- Keep PIN codes private and do not store the PIN codes in the device.
- Implement application-level security.

Bluetooth Profiles

The device supports the Bluetooth services listed.

Table 21 Bluetooth Profiles

Profile	Description
Service Discovery Protocol (SDP)	Handles the search for known and specific services as well as general services.
Serial Port Profile (SPP)	Allows use of RFCOMM protocol to emulate serial cable connection between two Bluetooth peer devices. For example, connecting the device to a printer.
Object Push Profile (OPP)	Allows the device to push and pull objects to and from a push server.
Advanced Audio Distribution Profile (A2DP)	Allows the device to stream stereo-quality audio to a wireless headset or wireless stereo speakers.
Audio/Video Remote Control Profile (AVRCP)	Allows the device to control A/V equipment to which a user has access. It may be used in concert with A2DP.

Table 21 Bluetooth Profiles (Continued)

Profile	Description
Personal Area Network (PAN)	Allows the use of Bluetooth Network Encapsulation Protocol to provide L3 networking capabilities over a Bluetooth link. Only PANU role is supported.
Human Interface Device Profile (HID)	Allows Bluetooth keyboards, pointing devices, gaming devices and remote monitoring devices to connect to the device.
Headset Profile (HSP)	Allows a hands-free device, such as a Bluetooth headset, to place and receive calls on the device.
Hands-Free Profile (HFP)	Allows car hands-free kits to communicate with the device in the car.
Phone Book Access Profile (PBAP)	Allows exchange of Phone Book Objects between a car kit and a mobile device to allow the car kit to display the name of the incoming caller; allow the car kit to download the phone book so you can initiate a call from the car display.
Out of Band (OOB)	Allows exchange of information used in the pairing process. Pairing is completed using the Bluetooth radio, but requires information from the OOB mechanism. Using OOB with NFC enables pairing when devices simply get close, rather than requiring a lengthy discovery process.
Symbol Serial Interface (SSI)	Allows for communication with Bluetooth Imager.
Generic Attribute Profile (GATT)	Provides profile discovery and description services for Bluetooth Low Energy protocol. It defines how attributes are grouped together into sets to form services.
Dial Up Networking (DUN)	Provides a standard to access the Internet and other dial-up services over Bluetooth.
Generic Access Profile (GAP)	Use for device discovery and authentication.
Object EXchange (OBEX)	Facilitates the exchange of binary objects between devices.

Bluetooth Power States

The Bluetooth radio is off by default.

- **Suspend** - When the device goes into Sleep mode, the Bluetooth radio stays on.
- **Airplane Mode** - When the device is placed in Airplane Mode, the Bluetooth radio is not turned off when the device is connected to a Bluetooth headset or hearing device.

Bluetooth Radio Power

Turn off the Bluetooth radio to save power or if entering an area with radio restrictions (for example, an airplane). When the radio is off, other Bluetooth devices cannot see or connect to the device. Turn on the Bluetooth radio to exchange information with other Bluetooth devices (within range). Communicate only with Bluetooth radios in close proximity.



NOTE: To achieve optimal battery life, turn off radios when not in use.

Enabling Bluetooth

1. Swipe down from the Status bar to open the Notification panel.
2. Touch  to turn Bluetooth on.

Disabling Bluetooth

1. Swipe down from the Status bar to open the Notification panel.
2. Touch  to turn Bluetooth off.

Discovering Bluetooth Device(s)

The device can receive information from discovered devices without pairing. However, once paired, the device and a paired device exchange information automatically when the Bluetooth radio is on.

1. Ensure that Bluetooth is enabled on both devices.
2. Ensure that the Bluetooth device to discover is in discoverable mode.
3. Ensure that the two devices are within 10 meters (32.8 feet) of one another.
4. Swipe down from the Status bar to open the Quick Access panel.
5. Touch and hold **Bluetooth**.
6. Touch **Pair new device**. The device begins searching for discoverable Bluetooth devices in the area and displays them under **Available devices**.
7. Scroll through the list and select a device. The Bluetooth pairing request dialog box appears.
8. Touch **Pair** on both devices.
9. The Bluetooth device is added to the **Paired devices** list and a trusted (“paired”) connection is established.

Changing the Bluetooth Name

By default, the device has a generic Bluetooth name that is visible to other devices when connected.

1. Go to **Settings**.
2. Touch **Connected devices** > **Connection preferences** > **Bluetooth**.
3. If Bluetooth is not on, move the switch to turn Bluetooth on.
4. Touch **Device name**.
5. Enter a name and touch **RENAME**.

Connecting to a Bluetooth Device

Once paired, connect to a Bluetooth device.

1. Go to **Settings**.
2. Touch **Connected devices** > **Connection preferences** > **Bluetooth**.

3. In the list, touch the unconnected Bluetooth device.
When connected, **Connected** appears below the device name.

Selecting Profiles on the Bluetooth Device

Some Bluetooth devices have multiple profiles.

1. Go to **Settings**.
2. Touch **Connected devices** > **Connection preferences** > **Bluetooth**.
3. In the **Paired Devices** list, touch  next to the device name.
4. Turn on or off a profile to allow the device to use that profile.

Unpairing a Bluetooth Device

Unpairing a Bluetooth device erases all pairing information.

1. Go to **Settings**.
2. Touch **Connected devices** > **Connection preferences** > **Bluetooth**.
3. In the **Paired Devices** list, touch  next to the device name.
4. Touch **FORGET**.

Near Field Communications

NFC/HF RFID is a short-range wireless connectivity technology standard that enables a secure transaction between a reader and a contactless smart card.

The technology is based on ISO/IEC 14443 type A and B (proximity), ISO/IEC 15693 (vicinity), and FeliCa standards, using the HF 13.56 MHz unlicensed band.

The device supports the following operating modes:

- Reader mode
- Peer-to-Peer communication
- Card Emulation mode.

Using NFC, the device can:

- Read contactless cards, such as contactless tickets, ID cards, and ePassport.
- Read and write information to contactless cards, such as SmartPosters and tickets, as well as devices with an NFC interface, such as vending machines.
- Read information from supported medical sensors.
- Pair with supported Bluetooth devices such as printers (for example, ZQ5x, ZD5x), ring scanners (for example, RS6000), and headsets (for example, HS3100).
- Exchange data with another NFC device.
- Emulate contactless cards such as a payment, ticket, or SmartPoster.

Reading NFC Cards

Read contactless cards using NFC.

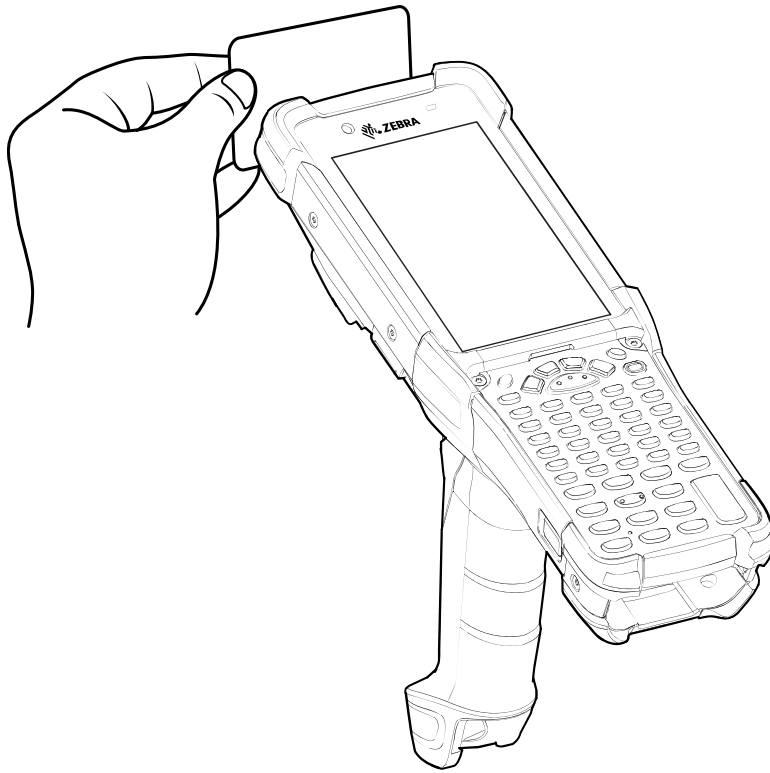

1. Launch an NFC enabled application.
2. Hold device as shown.
3. Move the device close to the NFC card until it detects the card.
4. Hold the card steadily until the transaction is complete (usually indicated by the application).

Sharing Information Using NFC

You can beam content like a web page, contact cards, pictures, YouTube links, or location information from your screen to another device by bringing the devices together back to back.

Make sure of the following:

- both devices are unlocked and support NFC
 - both devices have NFC and Nearby Share turned on
1. Open a screen that contains a web page, video, photo, or contact.
 2. Touch **Share**.
 3. Touch **Nearby Share**.
The device searches for other nearby devices.
 4. Move the front of the device toward the front of the other device.

When the devices connect, a sound emits, the image on the screen reduces in size, and the other device is prompted to accept the transfer.

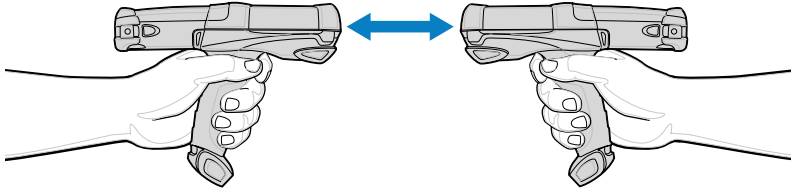

5. Click **Accept** on the other device.

The transfer begins.

Enterprise NFC Settings

Improve NFC performance or increase battery life by selecting which NFC features to use on the device.

- **Card Detection Mode** - Select a card detection mode.
 - **Low** - Increases battery life by lowering the NFC detection speed.
 - **Hybrid** - Provides a balance between NFC detection speed and battery life (default).
 - **Standard** - Provides the optimal NFC detection speed, but reduces battery life.
- **Supported Card Technology** - Select an option to detect only one NFC tag type, increasing battery life, but reducing detection speed.
 - **All (Default)** - Detects all NFC tag types. This provides the best detection speed, but reduces battery life.
 - **ISO 14443 Type A**
 - **ISO 14443 Type B**
 - FeliCa
 - **ISO 15693**
- **Other NFC settings available with Zebra administrator tools (CSP)** - Allows configuration of additional Enterprise NFC Settings through staging tools and Mobile Device Management (MDM) solutions with an MX version that supports the Enterprise NFC Settings Configuration Service Provider (CSP). For more information on using the Enterprise NFC Settings CSP, refer to: techdocs.zebra.com.

Cast

Use **Cast** to mirror the device screen on a Miracast enabled wireless display.

1. Go to **Settings**.
2. Touch **Connected devices** > **Connection preferences** > **Cast**.
3. Touch **⋮** > **Enable wireless display**.

The device searches for nearby Miracast devices and lists them.

4. Touch a device to begin casting.

Accessories

This section provides information for using the accessories for the device. The following table lists the accessories available for the device.

Accessory	Part Number	Description
Cradles		
1-Slot USB Charge Cradle with Spare Battery Charger	CRD-MC93-2SUCHG-01	Charges the main battery and a spare battery, and synchronizes the device with a host computer through a USB connection. Requires power supply (PWR-BGA12V50W0WW), DC line cord (CBL-DC-388A1-01), and a country-specific grounded AC line cord.
4-Slot Charge Only ShareCradle	CRD-MC93-4SCHG-01	Charges up to four devices. Requires power supply (PWR-BGA12V108W0WW), DC line cord (CBL-DC-381A1-01), and a country-specific grounded AC line cord.
4-Slot Ethernet ShareCradle	CRD-MC93-4SETH-01	Charges up to four devices through the main battery and synchronizes the devices with a host computer through an Ethernet connection. Requires power supply (PWR-BGA12V108W0WW), DC line cord (CBL-DC-381A1-01), and a country-specific grounded AC line cord.
Chargers		
4-Slot Spare Battery Charger	SAC-MC93-4SCHG-01	Charges up to four spare batteries. Requires power supply (PWR-BGA12V50W0WW), DC line cord (CBL-DC-388A1-01), and a country-specific grounded AC line cord.
16-Slot Spare Battery Charger	SAC-MC93-16SCHG-01	Charges up to 16 spare batteries. Requires power supply (PWR-BGA12V108W0WW), DC line cord (CBL-DC-381A1-01), and a country-specific grounded AC line cord.
Power Supply	PWR-BGA12V50W0WW	Provides 12 VDC, 4.16A power to the 1-Slot USB Charge Cradle, and the 4-Slot Spare Battery Charger. Requires a DC line cord (CBL-DC-388A1-01) and a country-specific grounded AC line cord.

Accessories

Accessory	Part Number	Description
Power Supply	PWR-BGA12V108W0WW	Provides 12 VDC, 9A power to the 4-Slot Charge Cradle with 4-Slot Battery Charger, and 16-Slot Battery Charger. Requires a DC line cord (CBL-DC-381A1-01) and a country-specific grounded AC line cord.
Power Supply	PWR-WUA5V12W0US	Provides 5 VDC, 2.5A power to the USB Charge Cable. Includes plug adapter for use in the United States.
Power Supply	PWR-WUA5V12W0GB	Provides 5 VDC, 2.5A power to the USB Charge Cable. Includes plug adapter for use in the European Union.
Power Supply	PWR-WUA5V12W0EU	Provides 5 VDC, 2.5A power to the USB Charge Cable. Includes plug adapter for use in the United Kingdom.
Power Supply	PWR-WUA5V12W0AU	Provides 5 VDC, 2.5A power to the USB Charge Cable. Includes plug adapter for use in Australia.
Power Supply	PWR-WUA5V12W0CN	Provides 5 VDC, 2.5A power to the USB Charge Cable. Includes plug adapter for use in China.
Power Supply	PWR-WUA5V12W0IN	Provides 5 VDC, 2.5A power to the USB Charge Cable. Includes plug adapter for use in India.
US AC Line Cord	23844-00-00R	Provides power to 3-wire power supplies PWR-BGA12V50W0WW and PWR-BGA12V108W0WW.
DC Line Cord	CBL-DC-381A1-01	Provides power from the power supply(PWR-BGA12V108W0WW) to the 4-Slot Charge Only Cradle, 4-Slot Ethernet Cradle, and 16-Slot Battery Charger.
DC Line Cord	CBL-DC-388A1-01	Provides power from the power supply (PWR-BGA12V150W0WW) to the 1-Slot USB Charge Cradle and 4-Slot Battery Charger.
Cables		
USB Charge/Com Snap-On Cup A separate USB cable and power supply are required to support fast charging. USB (Type-C) Cable is required to allow communication from the snap-on to the PC/laptop.	CBL-MC93-USBCHG-01	Provides power and/or communication over USB to the device. Requires wall adapter/power supply PWR-WUA5V12W0xx.
1-Slot Cradle USB Cable	CBL-TC2X-USBC-01	Provides USB communication through the 1-Slot USB cradle to the host computer.
Miscellaneous		
Cradle Adapter	ADP-MC93-CRDCUP-01	Charge Only Adapter for backward compatibility with other MC9XX cradles. Works with MC9XX 1-Slot USB Cradle and 4-Slot Charge Only Cradle.

Accessories

Accessory	Part Number	Description
7000mAh PowerPrecision+ standard battery	BTRY-MC93-STN-01	Replacement standard battery.
	BTRY-MC93-STN-10	Replacement standard battery (10-pack).
	BTRY-MC93-STN-IN	Replacement standard battery (India).
5000mAh PowerPrecision+ freezer battery	BTRY-MC93-FRZ-01	Replacement freezer battery.
	BTRY-MC93-FRZ-10	Replacement freezer battery (10-pack).
7000mAh PowerPrecision+ non-incendive battery	BTRY-MC93-NI-01	Replacement non-incendive battery.
	BTRY-MC93-NI-10	Replacement non-incendive battery (10-pack).
7000mAh PowerPrecision + standard battery with BLE beacon	BTRY-MC94-BLE-01	Replacement battery with BLE beacon.
	BTRY-MC94-BLE-10	Replacement battery with BLE beacon (10-pack).
	BTRY-MC94-BLE-IN	Replacement battery with BLE beacon (India).
Hand Strap	SG-MC93-HDSTPG-01	Replacement hand strap for the device. The hand strap loop holds an optional stylus (SG-TC7X-STYLUS-03).
Soft Holster for Gun	SG-MC9X-SHLSTG-01	Provides a soft, clip-on holster and a shoulder strap for the device.
Rubber Boot for Gun	SG-MC93-RBTG-01	Provides additional protection from wear and tear on the device.
Screen Protector	MISC-MC93-SCRN-01	Provides additional protection for display (5-pack).
Stylus and Tether	SG-TC7X-STYLUS-03	Conductive carbon-filled stylus for capacitive touch panel; includes coiled tether (3-pack).
Unpowered Forklift Mount	MNT-MC93-FLCH-01	Unpowered forklift mount. Allows installing the device on a roll bar or square surface of a forklift. Requires: <ul style="list-style-type: none"> • RAM double socket arm for 1-in. ball (MNT-RAM-B201U) • RAM forklift clamp 2.5-in. max width square rail base with 1-in. ball (MNT-RAM-B247U25)
34-key Numeric Keypad	KYPD-MC9334FNR-01	34-key Numeric Keypad
43-key Shifted Alpha Keypad	KYPD-MC9343FN-01	43-key Shifted Alpha Keypad
53-key Keypad (Alpha-Numeric)	KYPD-MC93535250-01	53-key Keypad (Alpha-Numeric)
53-key 5250 Emulator Keypad	KYPD-MC9353ANR-01	53-key 5250 Emulator Keypad
58-Keys OmniiXT15f Keypad	KYPD-MC9358ANR-01	58-Keys OmniiXT15f Keypad
29-Keys Shifted Alpha Keypad	KYPD-MC9329NMR-01	29-Keys Shifted Alpha Keypad

Accessories

Accessory	Part Number	Description
53-key 5250 Emulator Keypad (10 Pack)	KYPD-MC93535250-10	53-key 5250 Emulator Keypad (10 Pack) The 10 pack order includes a keypad installation tool.
53-key VT Emulator Keypad (10 Pack)	KYPD-MC9353VT-10	53-key VT Emulator Keypad (10 Pack) The 10 pack order includes a keypad installation tool.
53-key Keypad (Alpha-Numeric) (10 Pack)	KYPD-MC9353ANR-10	53-key Keypad (Alpha-Numeric) (10 Pack) The 10 pack order includes a keypad installation tool.
58-Keys OmniiXT15f Keypad	KYPD-MC9358ANR-10	58-Keys OmniiXT15f Keypad (10 Pack) The 10 pack order includes a keypad installation tool.

Accessories for Charging

Use one of the following accessories to charge the device and/or spare battery.

Table 22 Charging and Communication

Description	Part Number	Charging		Communication	
		Main Battery (In device)	Spare Battery	USB	Ethernet
1-Slot USB Charge Cradle with Spare Battery Charger	CRD-MC93-2SUCHG-01	Yes	Yes	Yes	No
4-Slot Charge Only ShareCradle	CRD-MC93-4SCHG-01	Yes	No	No	No
4-Slot Ethernet ShareCradle	CRD-MC93-4SETH-01	Yes	No	No	Yes
4-Slot Spare Battery Charger	SAC-MC93-4SCHG-01	No	Yes	No	No
16-Slot Spare Battery Charger	SAC-MC93-16SCHG-01	No	Yes	No	No
USB Charge/Com Snap-on Cup	CBL-MC93-USBCHG-01	Yes	No	Yes	No

1-Slot USB Charge Cradle with Spare Battery Charger

The 1-Slot USB charge cradle charges the main battery and a spare battery simultaneously.



NOTE: Ensure that you follow the guidelines for battery safety described in [Battery Safety Guidelines](#).

The 1-Slot USB Charge Cradle with spare battery:

- Provides 9 VDC power to operate the mobile computer and charge the battery.
- Provides 4.2 VDC power to charge the spare battery.
- Provides a USB port for data communication between the mobile computer and a host computer or other USB devices, for example, a printer.
- Synchronizes information between the mobile computer and a host computer. With customized or third-party software, it can also synchronize the mobile computer with corporate databases.
- Compatible with the following batteries:
 - 7000mAh PowerPrecision+ standard battery
 - 7000mAh PowerPrecision+ standard battery with BLE beacon
 - 5000mAh PowerPrecision+ freezer battery
 - 7000mAh PowerPrecision+ non-incendive battery.

Figure 14 1-Slot USB Charge Cradle with Spare Battery Charger

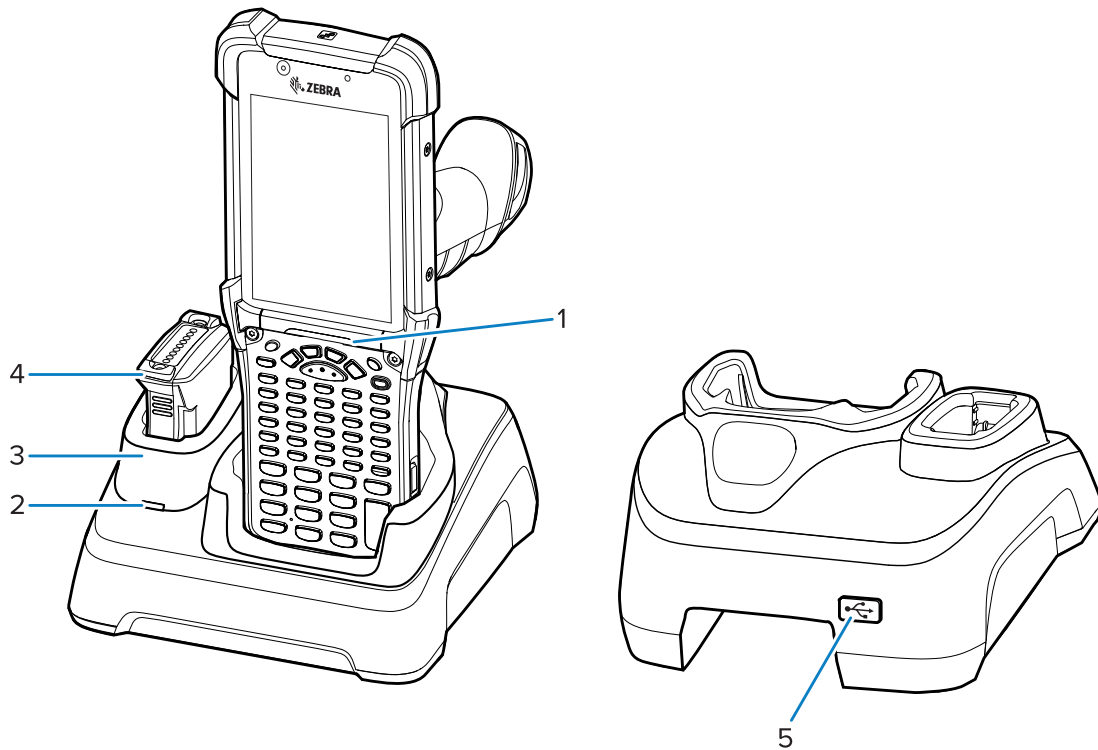

1	Indicator LED bar
2	Spare battery charging LED
3	Spare battery charging well
4	Spare battery
5	USB port (for service only)

Setup

Figure 15 1-Slot USB Charge Cradle with Spare Battery Charger Setup

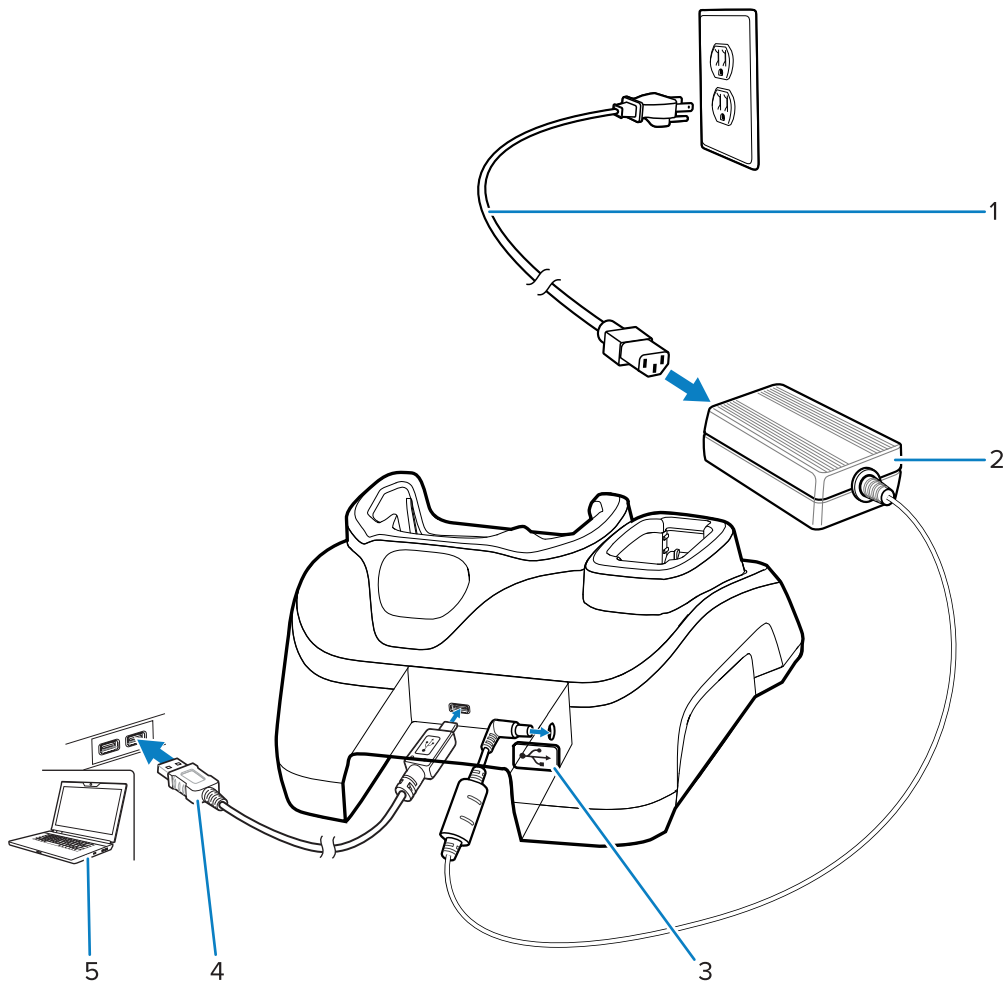

1	AC line cord
2	Power supply
3	USB port (for service only)
4	USB cable
5	Host computer

Charging the Device

To achieve optimal charging results, use only Zebra charging accessories and batteries. Charge batteries at room temperature with the device in sleep mode.

A standard battery charges from fully depleted to 90% in approximately 4 hours and from fully depleted to 100% in approximately 5 hours. In many cases, a 90% charge provides enough charge for daily use. Depending on the usage profile, a full 100% charge may last for approximately 14 hours of use.



NOTE: Follow the guidelines for battery safety described in the Batter Best Practices file available at zebra.com/powerprecision.

The device or accessory always performs battery charging in a safe and intelligent manner. The device or accessory indicates when charging is disabled due to abnormal temperatures via its LED, and a notification appears on the device display.

Temperature	Battery Charging Behavior
0°C to 40°C (32°F to 104°F)	Optimal charging range.
0 to 20°C (32 to 68°F) 37 to 40°C (98 to 104°F)	Charging slows to optimize the JEITA requirements of the cell.
Below 0°C (32°F) Above 40°C (104°F)	Charging stops.
Above 58°C (136°F)	The device shuts down.

To charge the device using a cradle:

1. Connect the cradle to the appropriate power source.
2. Insert the device into the slot in the cradle to begin charging. Gently press down on the device to ensure that it is properly seated.

Figure 16 1-Slot USB Charge Cradle with Spare Battery Charger

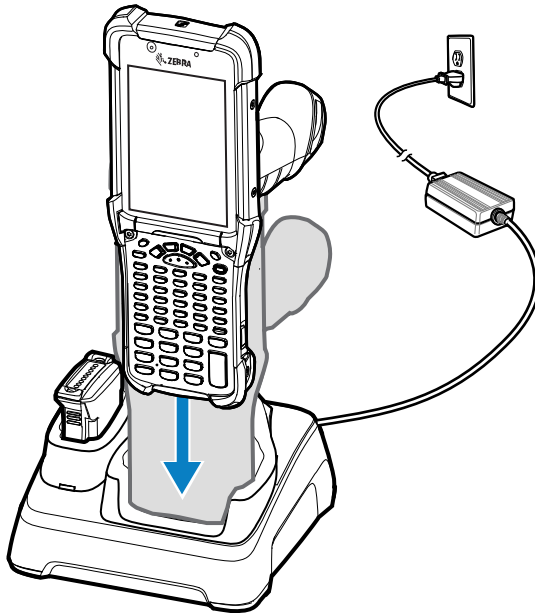

The device turns on and begins charging. The charging/notification LED indicates the battery charging status.

3. When charging is complete, remove the device from the cradle slot.

See Also

[Charging Indicators](#)

4-Slot Charge Only ShareCradle



NOTE: Ensure that you follow the guidelines for battery safety described in [Battery Safety Guidelines](#).

The 4-Slot Charge Only ShareCradle:

- Provides 9 VDC power to operate the mobile computer and charge the battery.
- Simultaneously charges up to four mobile computers.
- Compatible with devices using the following batteries:
 - 7000mAh PowerPrecision+ standard battery
 - 7000mAh PowerPrecision+ standard battery with BLE beacon
 - 5000mAh PowerPrecision+ freezer battery
 - 7000mAh PowerPrecision+ non-incendive battery.

Figure 17 4-Slot Charge Only ShareCradle

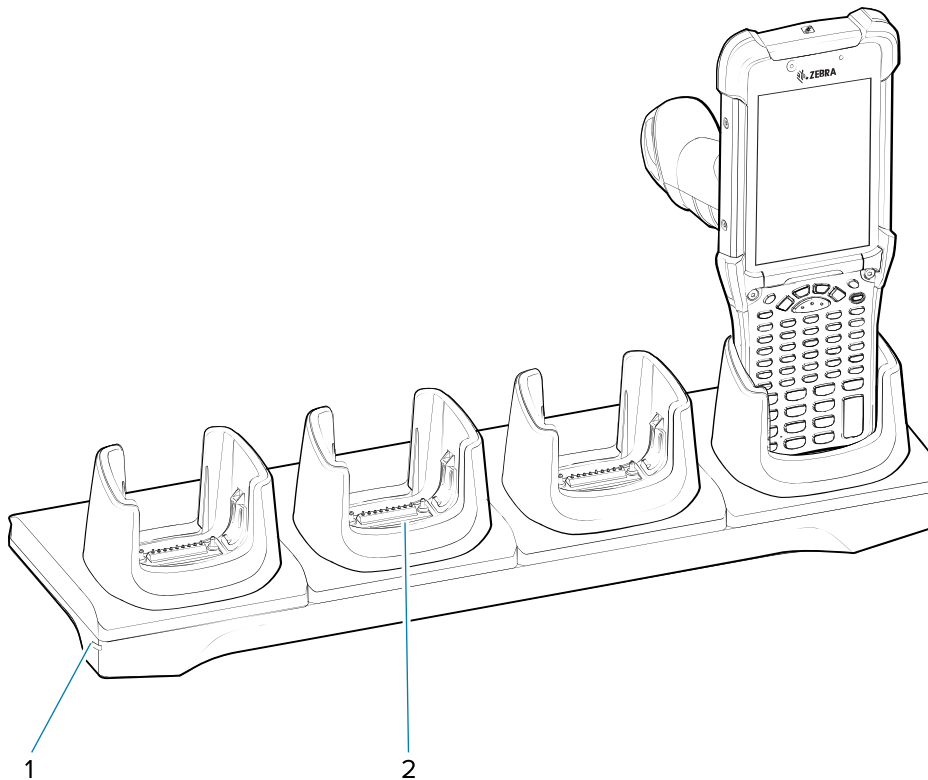

1	Power LED
2	Charging slot

Setup

Figure 18 4-Slot Charge Only ShareCradle Setup

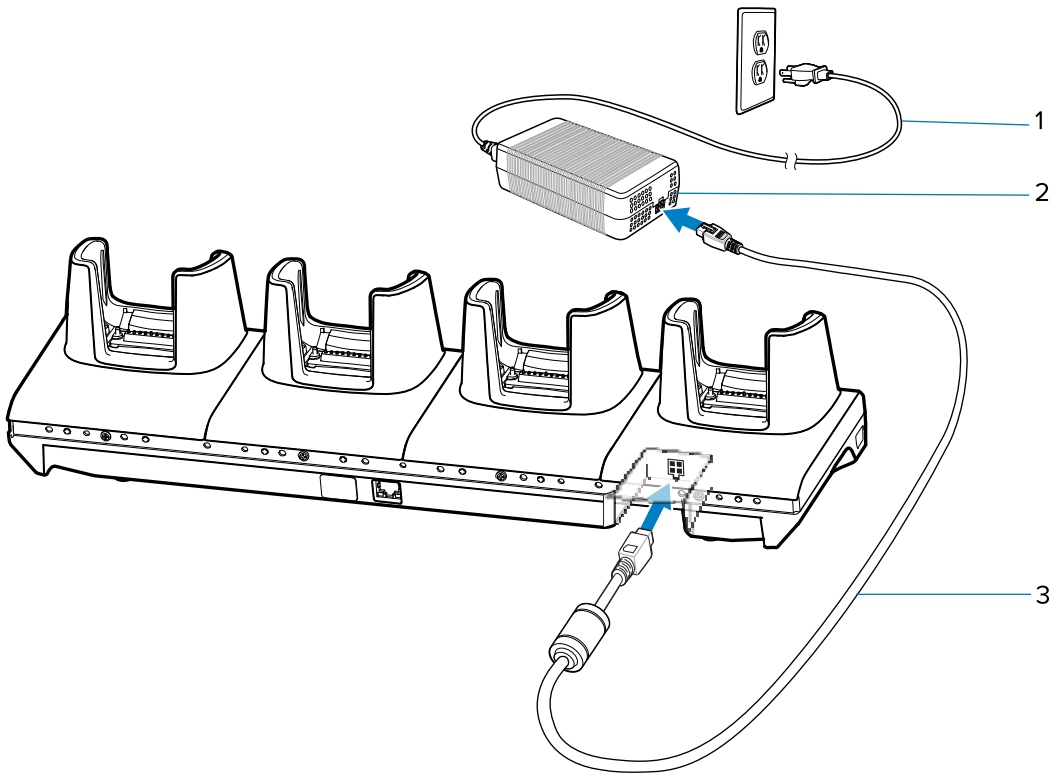

1	AC line cord
2	Power supply
3	DC line cord

Charging the Devices

1. Connect the cradle to a power source.

Figure 19 4-Slot Charge Only ShareCradle

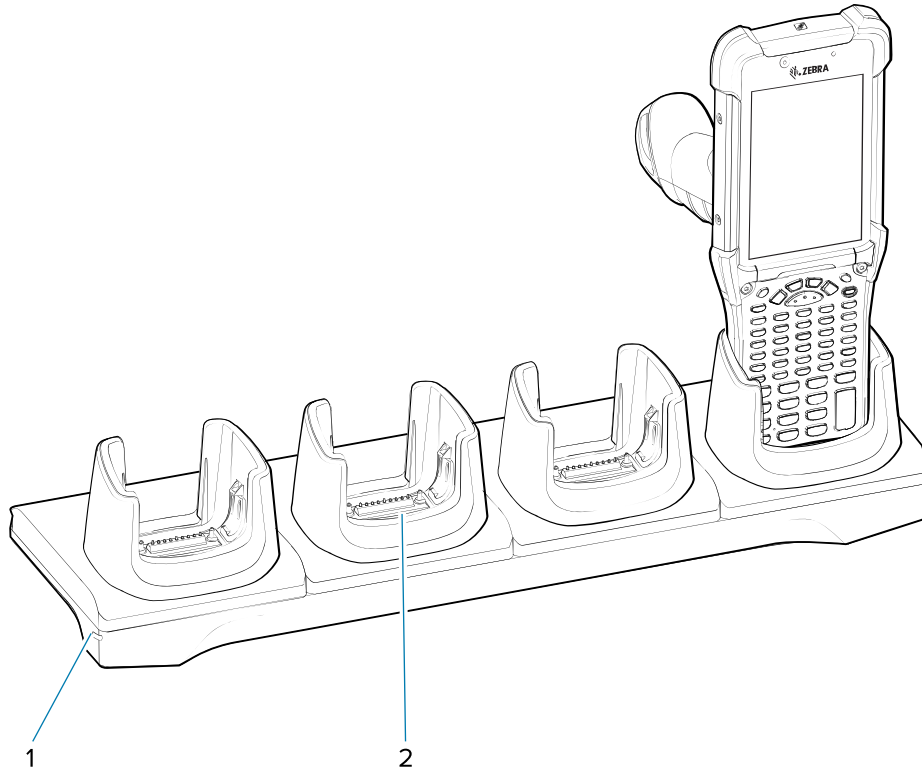

1	Power LED
2	Charging Slot

2. Slide the devices into the slots in the cradle. The device Charge LED Indicator, indicates the battery charging status.
3. Gently press down on the device to ensure proper contact.
4. When charging is complete, remove the devices from the cradle slot.

4-Slot Ethernet ShareCradle



NOTE: Ensure that you follow the guidelines for battery safety described in [Battery Safety Guidelines](#).

The 4-Slot Ethernet ShareCradle:

- Provides 9 VDC power to operate the mobile computer and charge the battery.
- Simultaneously charges up to four mobile computers.
- Connects up to four devices to an Ethernet network.

- Compatible with devices using the following batteries:
 - 7000mAh PowerPrecision+ standard battery
 - 7000mAh PowerPrecision+ standard battery with BLE beacon
 - 5000mAh PowerPrecision+ freezer battery
 - 7000mAh PowerPrecision+ non-incendive battery.

Figure 20 4-Slot Ethernet ShareCradle

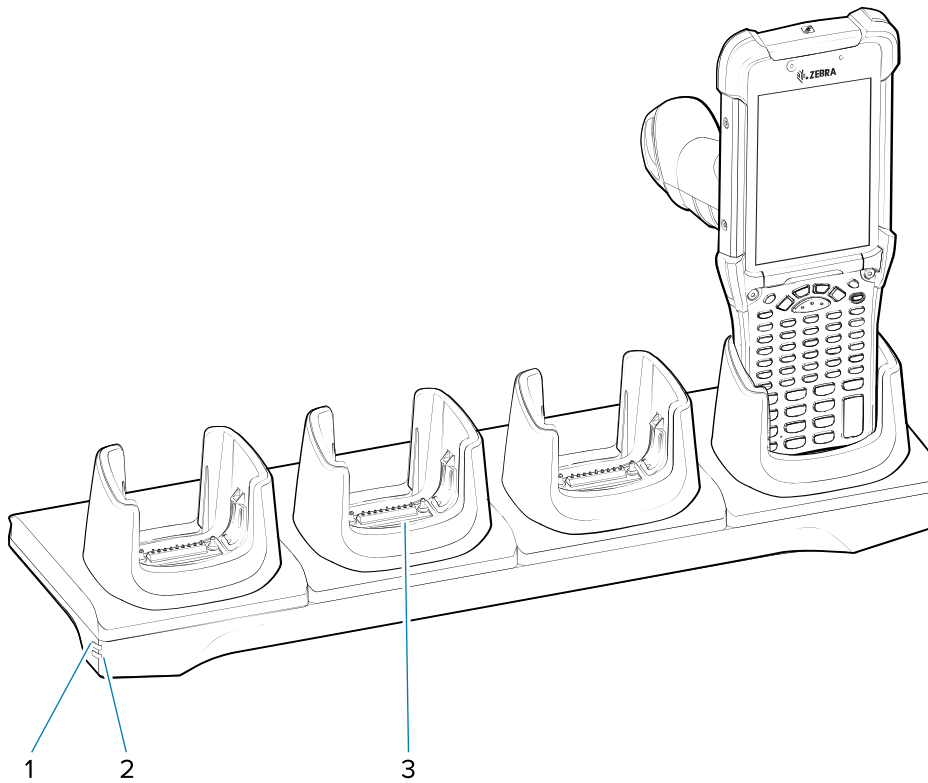

1	1000Base-T LED
2	10/100Base-T LED
3	Charging slot

Setup

Figure 21 4-Slot Ethernet ShareCradle Setup

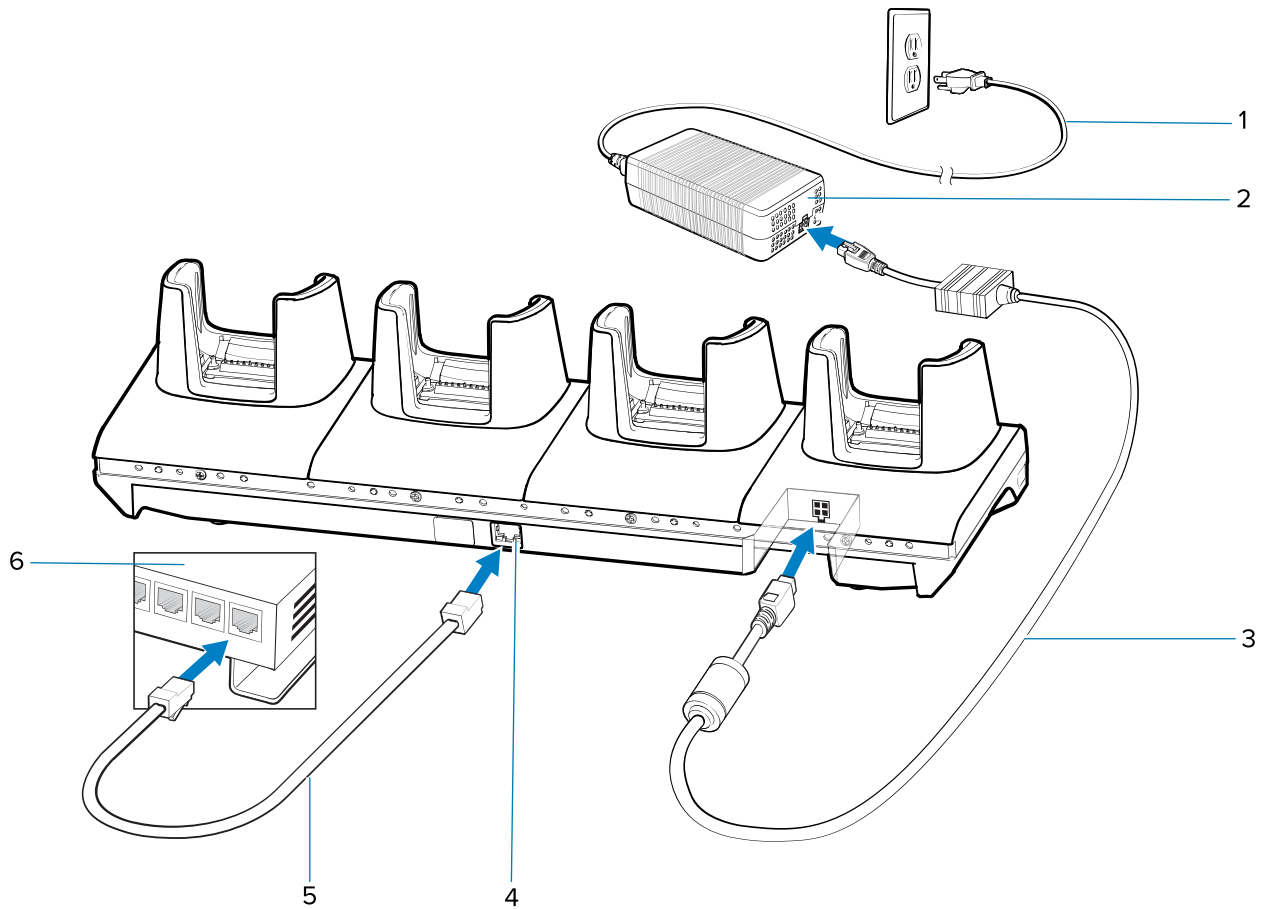

1	AC line cord
2	Power supply
3	DC line cord
4	Primary port
5	Ethernet cable
6	Router

Charging the Devices

1. Connect the cradle to a power source.

Figure 22 4-Slot Charge Only ShareCradle

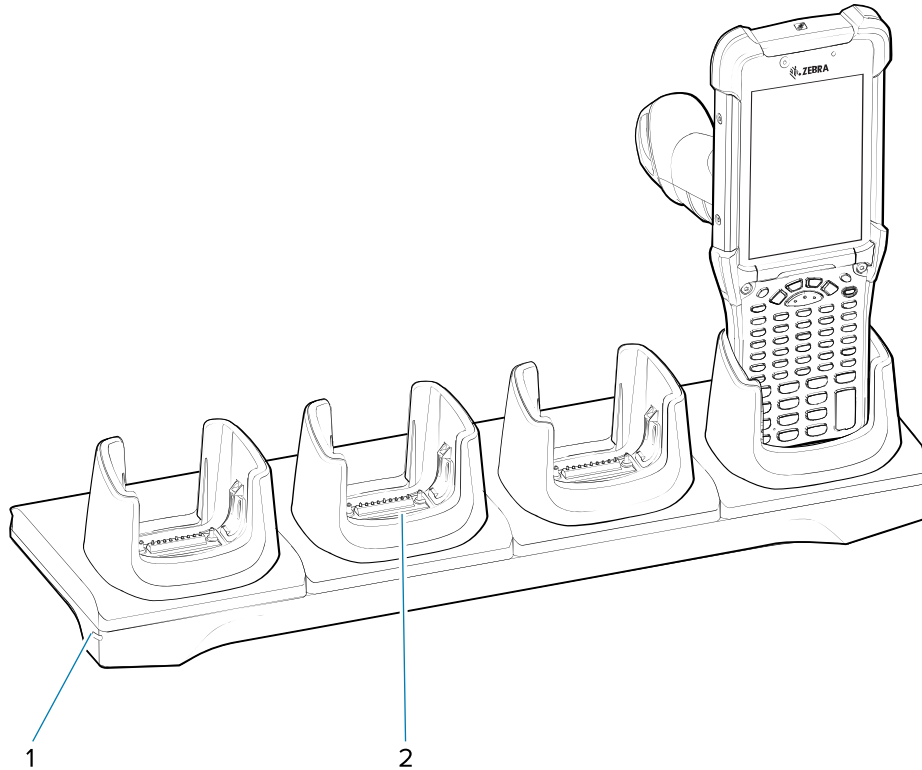

1	Power LED
2	Charging Slot

2. Slide the devices into the slots in the cradle. The device Charge LED Indicator, indicates the battery charging status.
3. Gently press down on the device to ensure proper contact.
4. When charging is complete, remove the devices from the cradle slot.

Daisy-chaining Ethernet ShareCradles

Daisy-chain up to ten 4-Slot Ethernet ShareCradles to connect several cradles to an Ethernet network. Use either a straight or crossover cable. Daisy-chaining should not be attempted when the main Ethernet connection to the first cradle is 10 Mbps as throughput issues will almost certainly result.

1. Connect power to each 4-Slot Ethernet ShareCradle.
2. Connect an Ethernet cable to one of the ports on the switch and the other end to the Primary Port of the first cradle.
3. Connect an Ethernet cable to the Secondary port of the first cradle.

- Connect the other end of the Ethernet cable to the Primary port of the next 4-Slot Ethernet ShareCradle.

Figure 23 Daisy-chaining 4-Slot Ethernet ShareCradles

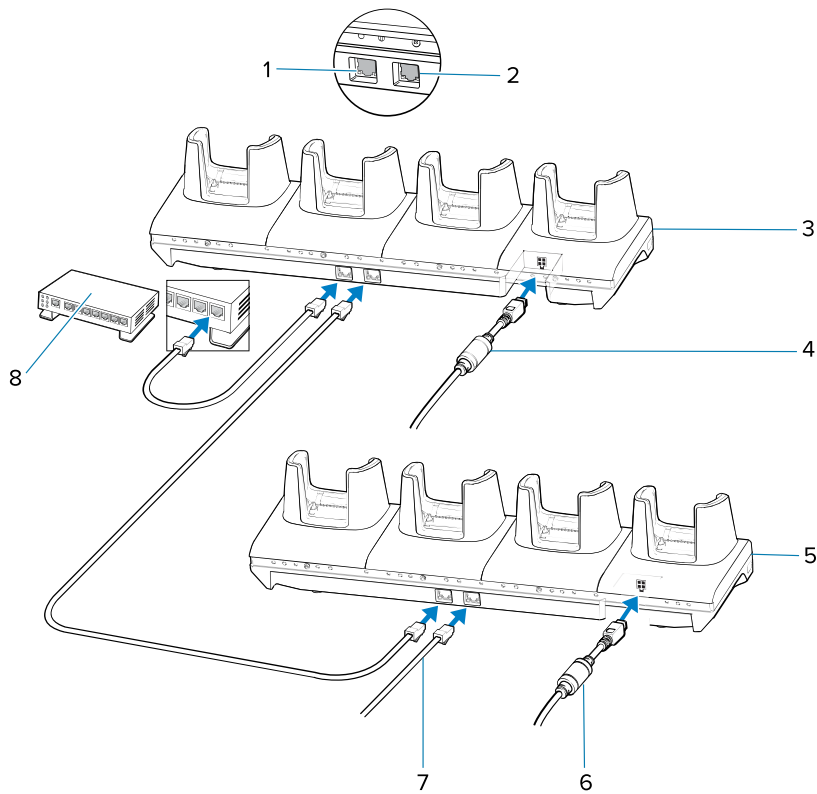

1	Primary port
2	Secondary port
3	First cradle
4	To power supply
5	Second cradle
6	To power supply
7	Ethernet cable to next cradle
8	To Ethernet switch

- Connect additional cradles as described in step 3 and 4.

Ethernet Settings

The following settings can be configured when using Ethernet communication:

- Proxy settings
- Static IP.

Configuring Ethernet Proxy Settings

The device includes Ethernet cradle drivers. After inserting the device into the cradle, configure the Ethernet connection.

1. Swipe down from the status bar to open the quick access panel and then touch .
2. Touch **Network & Internet > Ethernet**.
3. Slide the switch to the **ON** position.
4. Place the device into the Ethernet cradle slot.
5. Touch and hold **eth0** until the menu appears.
6. Touch **Modify Proxy**.
7. Touch the **Proxy** drop-down list and select **Manual**.
8. In the **Proxy hostname** field, enter the proxy server address.



NOTE: When entering proxy addresses in the Bypass proxy for field, do not use spaces or carriage returns between addresses.

9. In the **Proxy port** field, enter the proxy server port number.
10. In the **Bypass proxy for** text box, enter addresses for web sites that do not require to go through the proxy server. Use the separator comma “,” between addresses.
11. Touch **MODIFY**.
12. Touch the Home button.

Configuring Ethernet Static IP Address

The device includes Ethernet cradle drivers. After inserting the device into the cradle, configure the Ethernet connection.

1. Swipe down from the status bar to open the quick access panel and then touch .
2. Touch **Network & Internet > Ethernet**.
3. Slide the switch to the **ON** position.
4. Place the device into the Ethernet cradle slot.
5. Touch **eth0**.
6. Touch **Disconnect**.
7. Touch **eth0**.
8. Touch the IP settings drop-down list and select **Static**.
9. In the **IP** address field, enter the proxy server address.
10. If required, in the **Gateway** field, enter a gateway address for the device.
11. If required, in the **Netmask** field, enter the network mask address
12. If required, in the **DNS** address fields, enter a Domain Name System (DNS) addresses.
13. Touch **CONNECT**.
14. Touch the Home button.

Establishing Ethernet Connection

1. Double-swipe down from the top of the Home screen to open the Quick Access panel and touch .
2. Touch **Network & Internet > Ethernet**.
3. Slide the Ethernet switch to the **ON** position.
4. Place the device into the Ethernet cradle slot.
5. Touch **eth0** to view Ethernet connection details.

LED Indicators

There are two green LEDs on the side of the cradle. These green LEDs light and blink to indicate the data transfer rate.

Table 23 LED Data Rate Indicators

Data Rate	1000 LED	100/10 LED
1 Gbps	On/Blink	Off
100 Mbps	Off	On/Blink
10 Mbps	Off	On/Blink

4-Slot Spare Battery Charger



NOTE: Ensure that you follow the guidelines for battery safety described in [Battery Safety Guidelines](#).

The 4-Slot Spare Battery Charger:

- Charges up to four spare batteries.
- Provides 4.2 VDC power to charge the spare battery.

Figure 24 4-Slot Spare Battery Charger Cradle

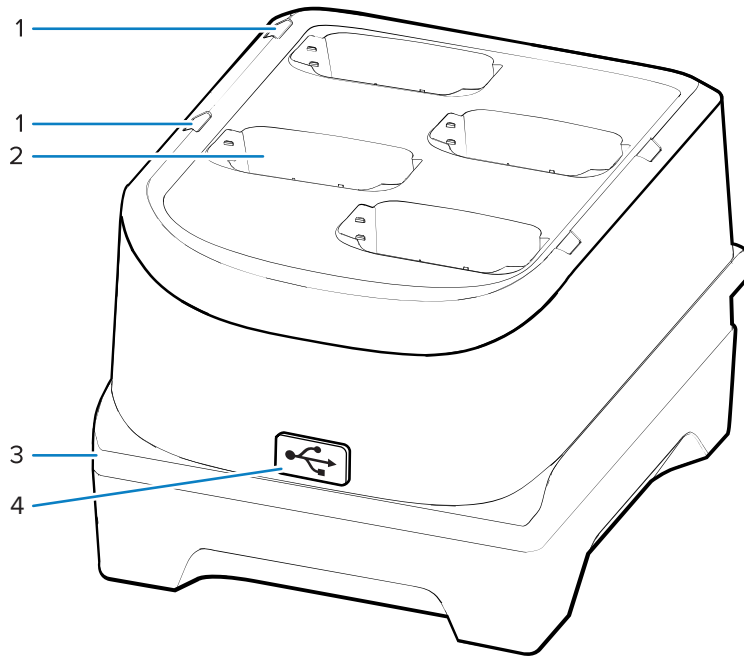

1	Spare battery charging LEDs
2	Charging slot
3	Power LED
4	USB port (for service only)

Setup

Figure 25 4-Slot Spare Battery Charger Setup

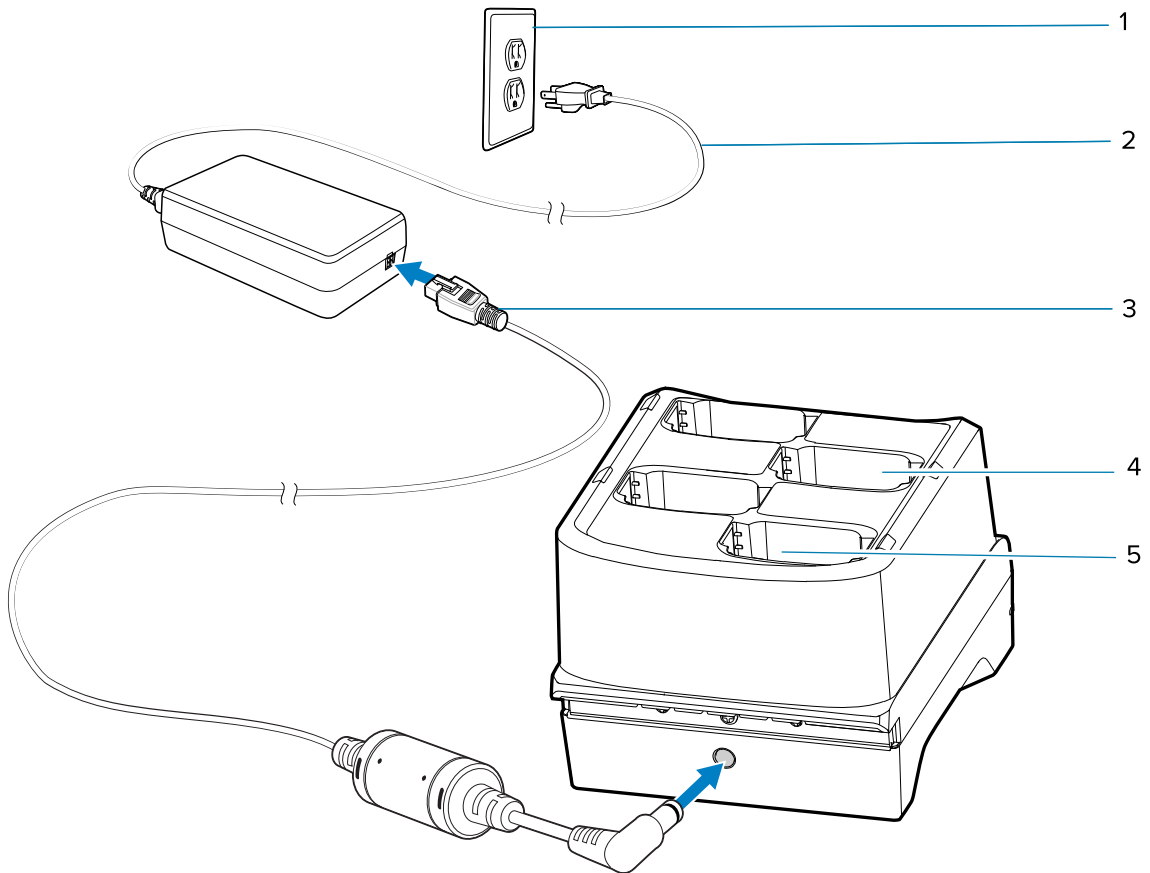

1	Power supply
2	AC line cord
3	DC line cord
4	Spare battery charging LED
5	Charging slot

Charging the Spare Batteries

1. Connect the charger to a power source.

Figure 26 4-Slot Spare Battery Charger

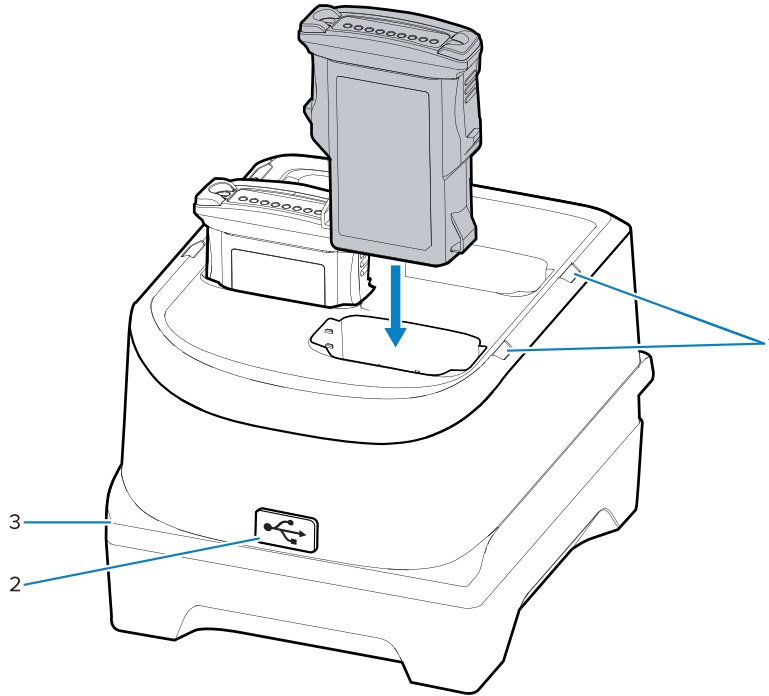

1	Spare battery charging LEDs
2	USB port (for service only)
3	Power LED

2. Insert the battery into a spare battery charging slot and gently press down on the battery to ensure proper contact.

16-Slot Spare Battery Charger



NOTE: Ensure that you follow the guidelines for battery safety described in [Battery Safety Guidelines](#).

The 16-Slot Spare Battery Charger:

- Charges up to 16 spare batteries.
- Provides 4.2 VDC power to charge the spare battery.

Figure 27 16-Slot Spare Battery Charger

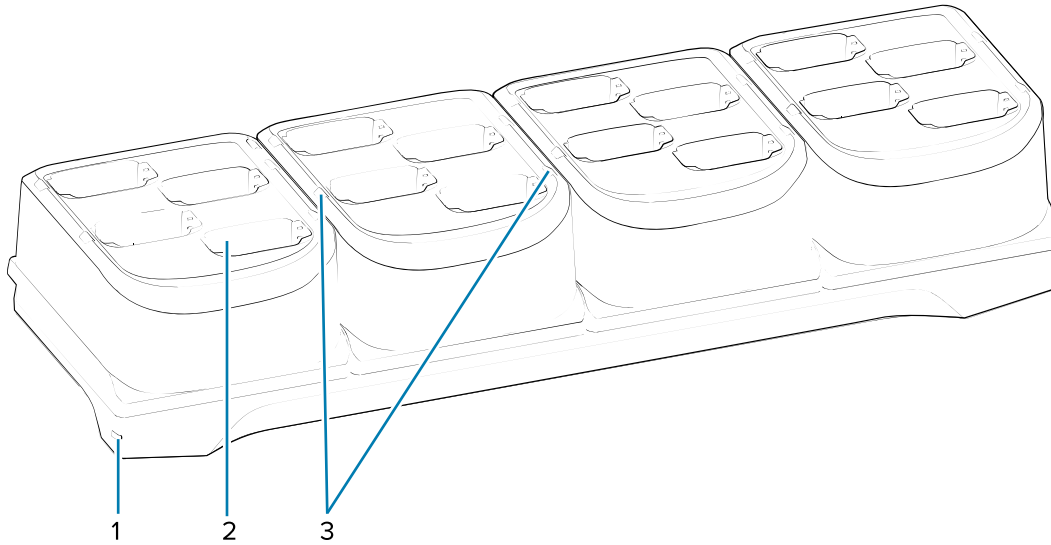

1	Power LED
2	Charging slot
3	Spare battery charging LEDs

Setup

Figure 28 16-Slot Spare Battery Charger Setup

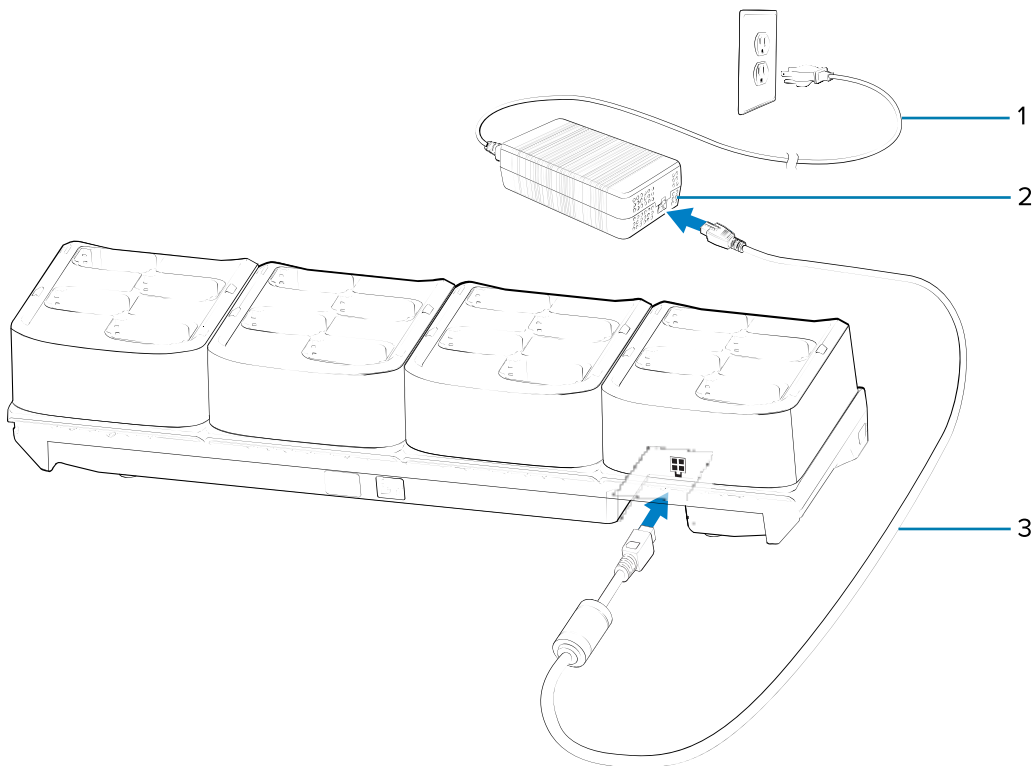

1	AC line cord
2	Power supply
3	DC line cord

Charging the Spare Batteries

1. Connect the charger to a power source.

Figure 29 16-Slot Spare Battery Charger

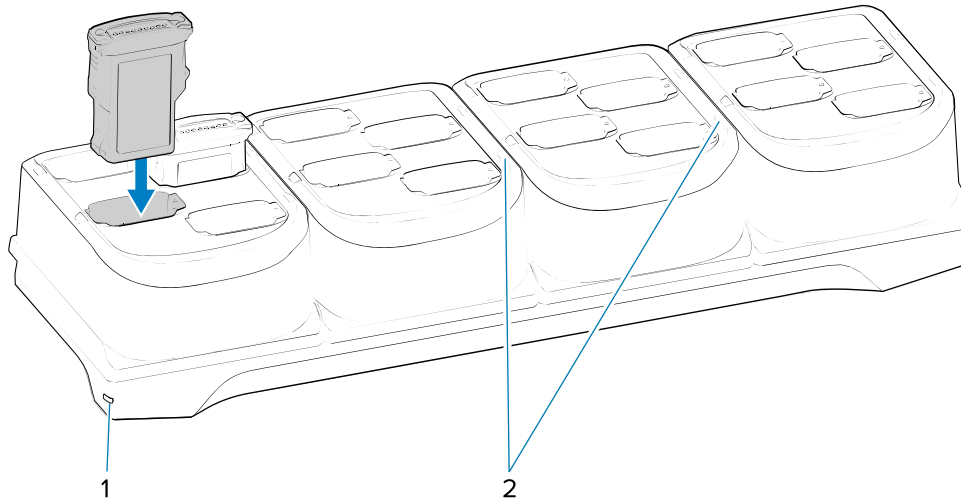

1	Power LED
2	Spare battery charging LEDs

2. Insert the battery into a spare battery charging slot and gently press down on the battery to ensure proper contact.

USB Charge/Com Snap-on Cup



NOTE: Ensure that you follow the guidelines for battery safety described in [Battery Safety Guidelines](#).

The USB Charge/Com Snap-on Cup:

- Provides 5 VDC power to operate the device and to charge the battery.
- Provides power and/or communication with the host computer over USB to the device.

Figure 30 USB Charge/Com Snap-on Cup

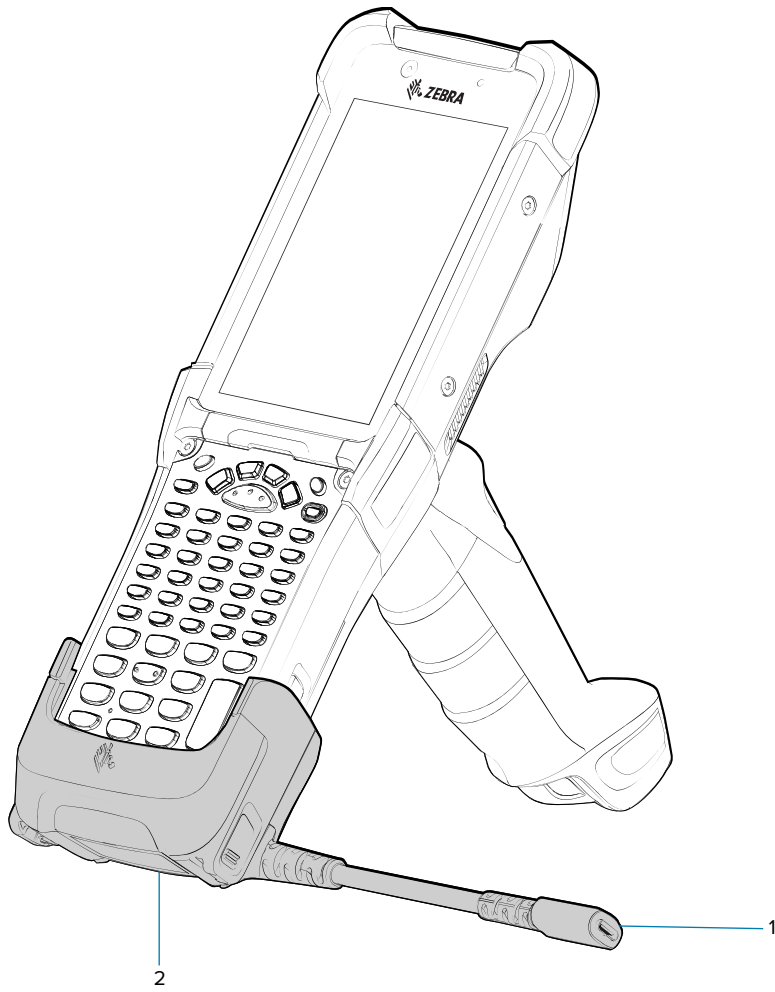

1	Pigtail with USB Type C socket
2	USB charge/com snap-on cup

Connecting to the Device

To function properly, remove the lower part of the rubber boot or the entire rubber boot before placing the device in a charging cradle.

- Insert the device straight onto the USB Charge/Com Snap-on Cup until the device touches the bottom of the cable cup.

Figure 31 Connecting the USB Charge/Com Snap-on Cup

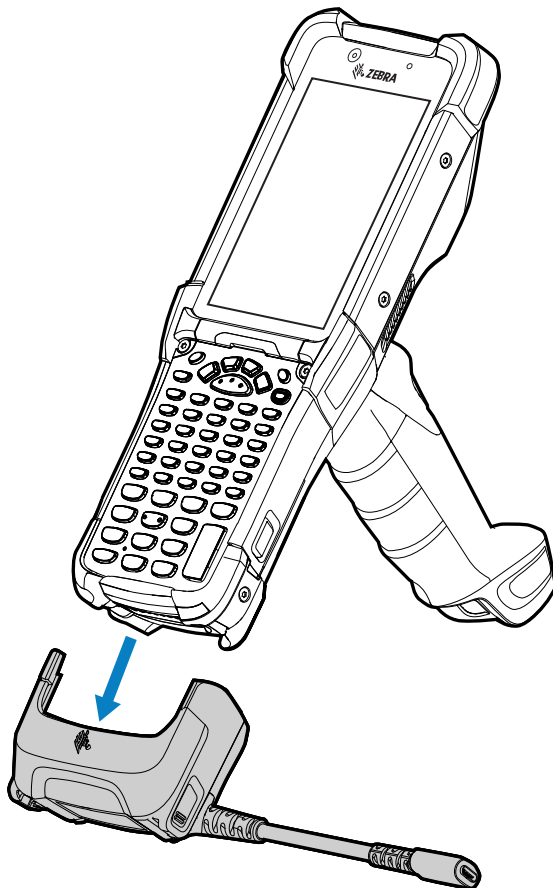

Connecting the USB Charge/Com Snap-on Cup Cable to Host Computer

1. Connect the USB Charge/Com Snap-on Cup (3) to the device.

2. Connect the USB connector (2) to a host computer (1).

Figure 32 Connecting USB Charge/Com Snap-on Cup to Host Computer

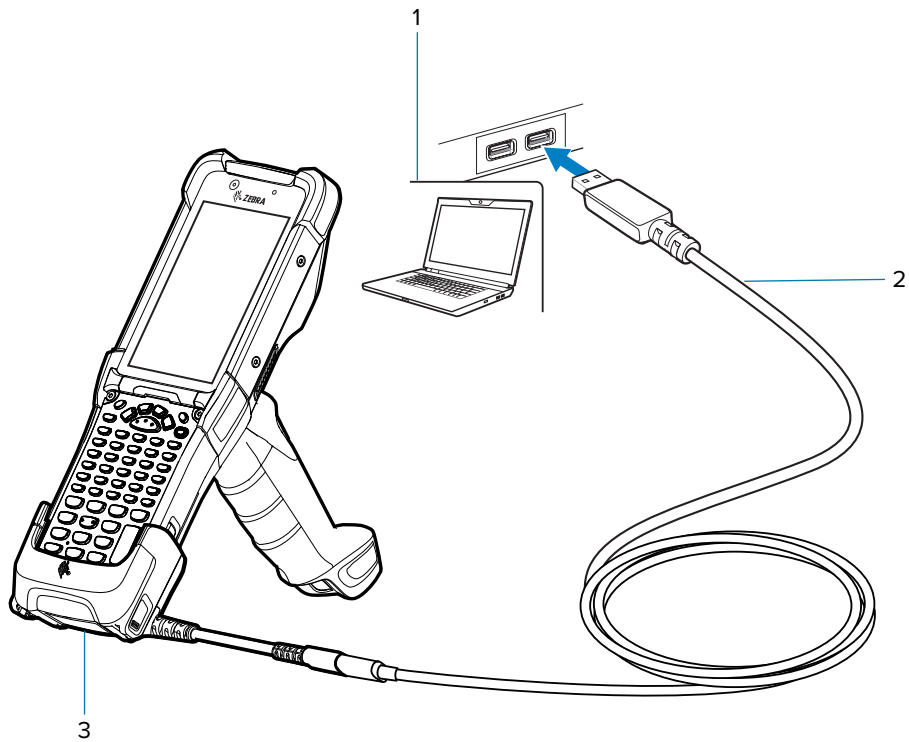

Charging the Device with the USB Charge/Com Snap-on Cup

To charge the device using the USB Charge/Com Snap-on Cup:

1. Connect the USB Charge/Com Snap-on Cup to the device.
2. Connect the USB connector (2) of the power supply.

3. Plug the power supply into a power outlet (1).

Figure 33 Charging the Device using the USB Charge Cable

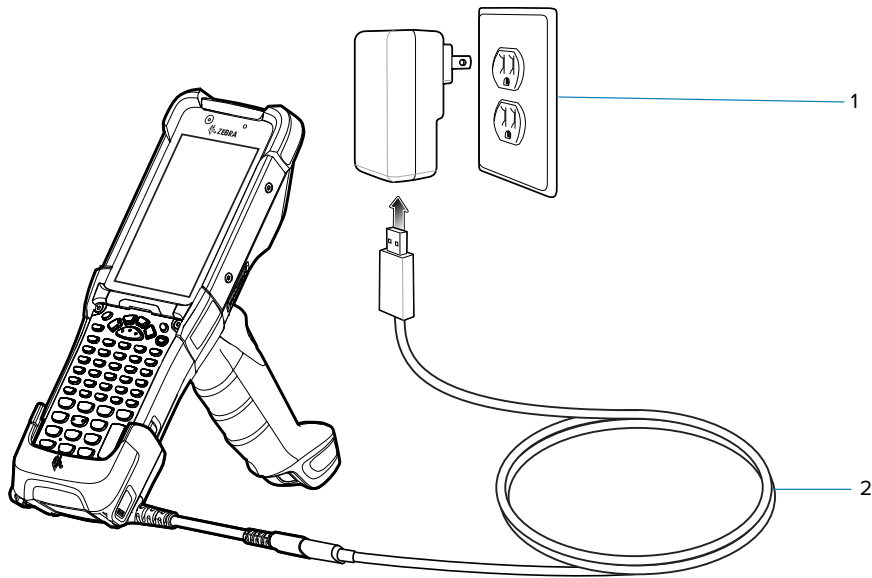

Disconnecting the USB Charge/Com Snap-on Cup

1. Depress the two latches on either side of the cup.
2. Pull the cup off the bottom of the device.

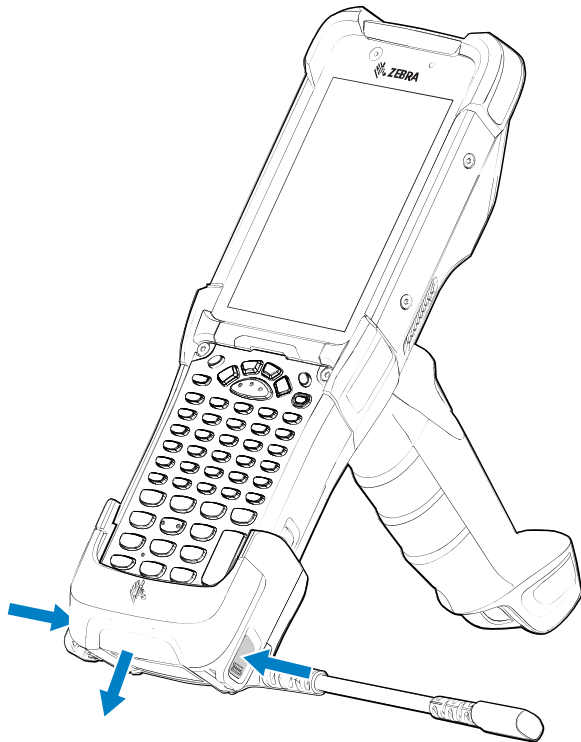

Charge Only Adapter

Use the charge only adapter for compatibility with other MC9x cradles.

- The charge only adapter can be installed on any MC9x single-slot or multi-slot cradle (charge only or Ethernet).
- When used with MC9x cradles, the adapter provides the ability to charge but no USB or Ethernet communication.

Figure 34 MC9x 1-Slot Cradle with Charge Only Adapter

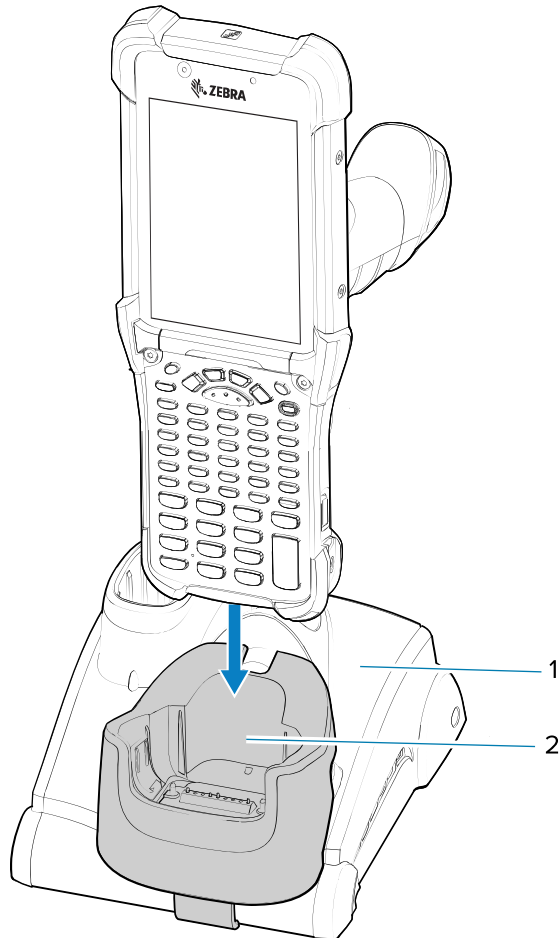

1	MC9x 1-Slot cradle
2	Charge only adapter

Figure 35 MC9x 4-Slot Cradle Charge Only Adapter

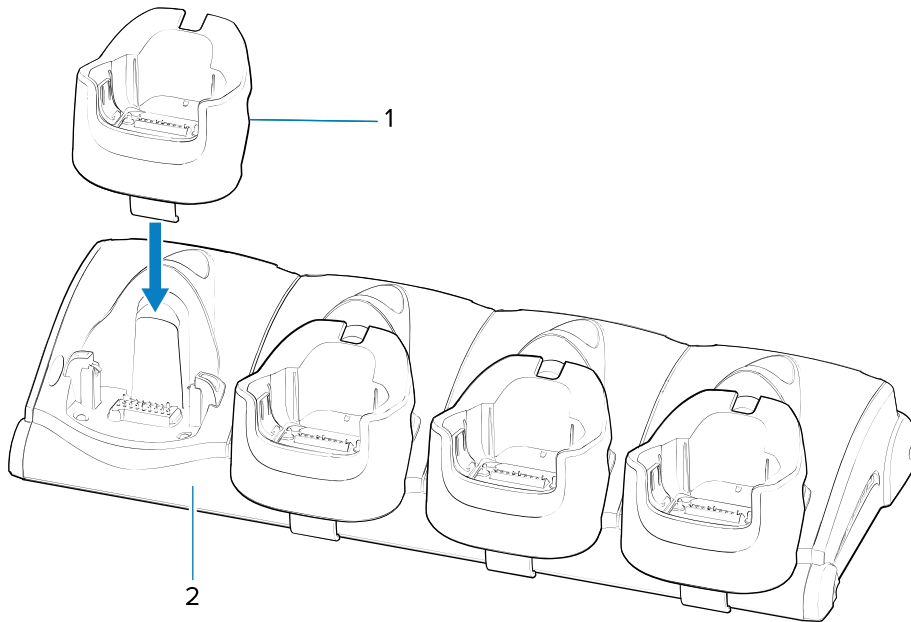

1	Charge only adapter
2	MC9x 4-Slot cradle

Installing the Adapter

Follow these instructions to install the charge only adapter.

1. Clean the cradle and contacts surface (1) with an alcohol wipe, using a back and forth motion with your finger. For more information about cleaning, see [Maintenance and Troubleshooting](#) on page 200.

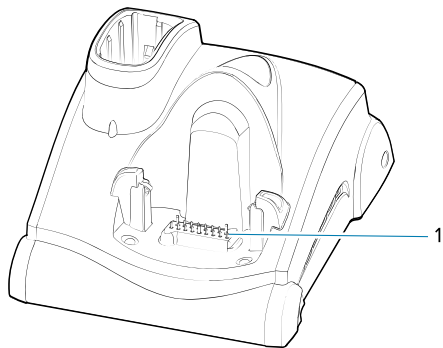

2. Peel and remove the adhesive (1) from the back of the adapter.

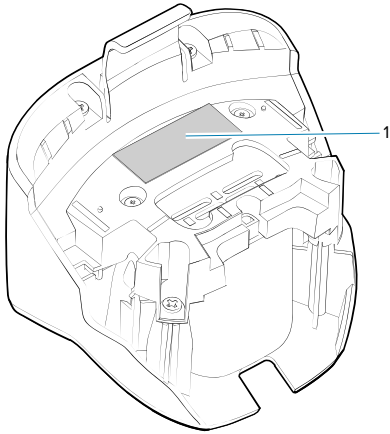

3. Insert the adapter into the MC9x cradle, and press it into the bottom of the cradle.

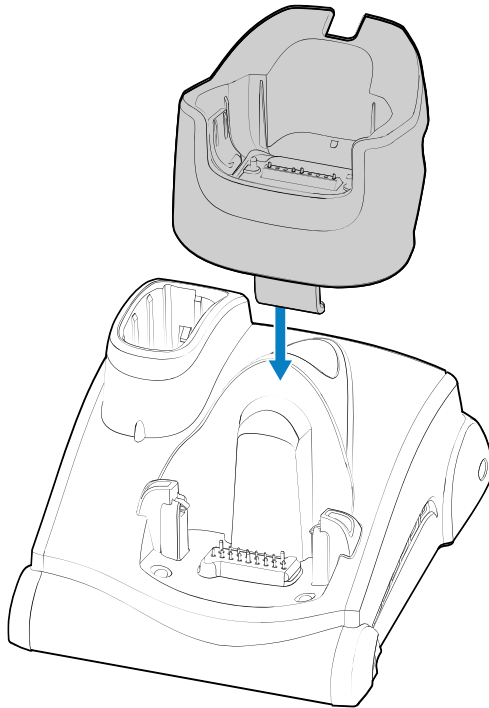

4. Insert the device into the adapter (2).

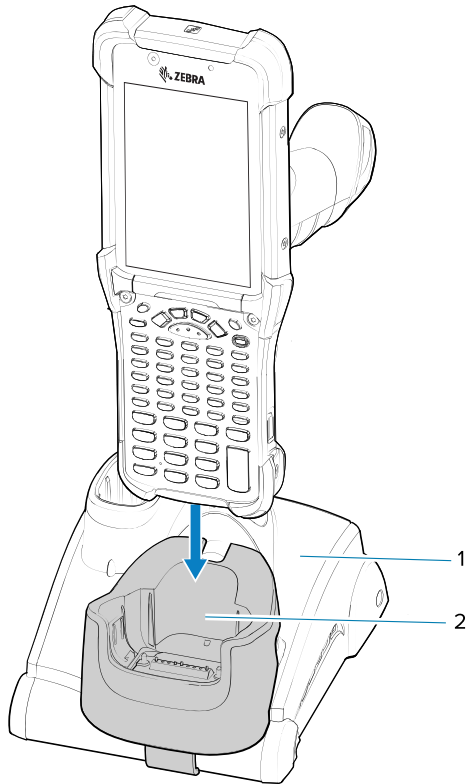

Attaching the Rubber Boot



NOTE: To charge the device in a cradle, completely remove the rubber boot.

1. Snap off the shim by pushing it through.

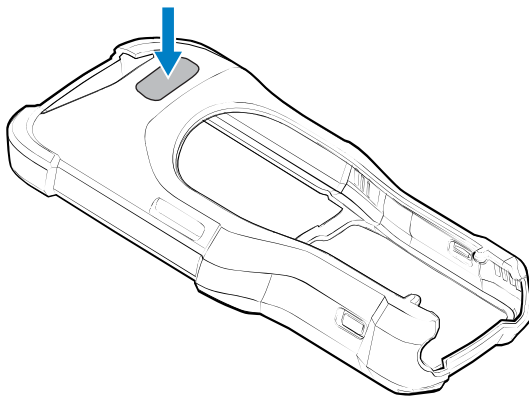

2. Slide the top of the device into the top of the rubber boot.

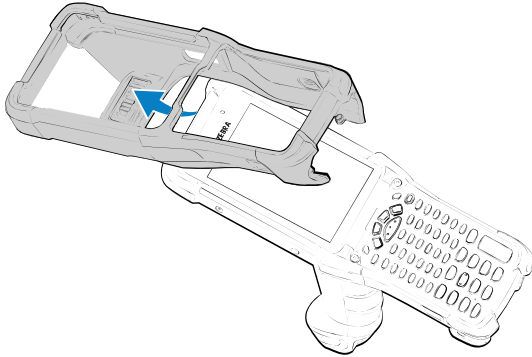

3. Grasp the bottom of the rubber boot and place it over the bottom of the device.

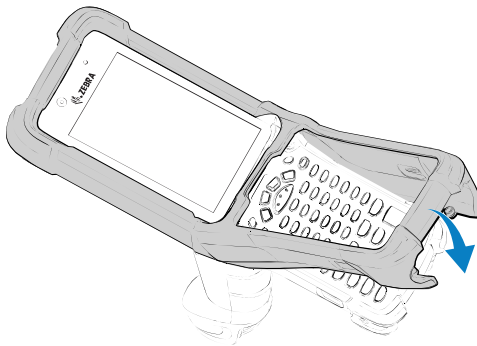

4. Turn the device over and ensure that the two alignment tabs (1) completely fit into the two alignment slots on the device.

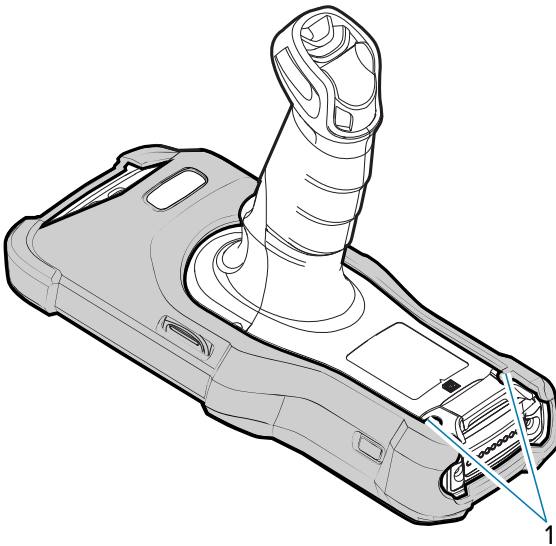

Installing the Hand Strap

1. Thread and pull through the short section through the opening near the base of the trigger handle.

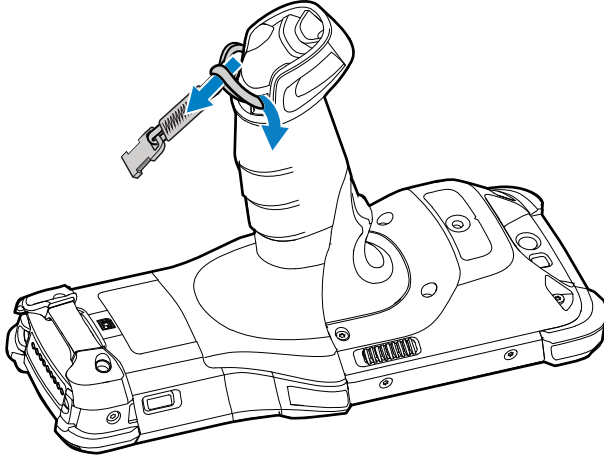

2. Thread and pull through the longer section through the opening near the battery.

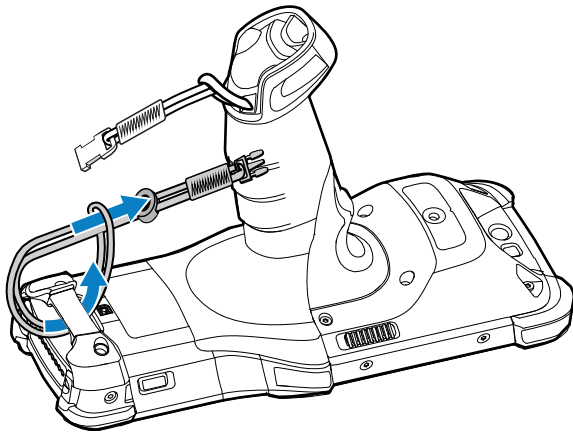

3. Attach the two plastic ends together.

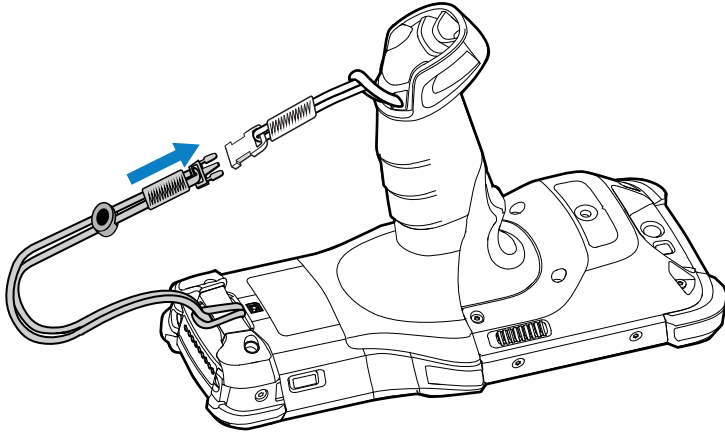

Fabric Holster

The fabric holster provides a soft holder for the device. Optional accessories, such as a detachable belt strap and a shoulder strap, are also available.

The following instructions tell how to attach the fabric holster to a belt or shoulder strap.

Using the Belt Strap

The fabric holster holds the device on a belt.

1. Position a belt loop over the belt, and snap it into place.

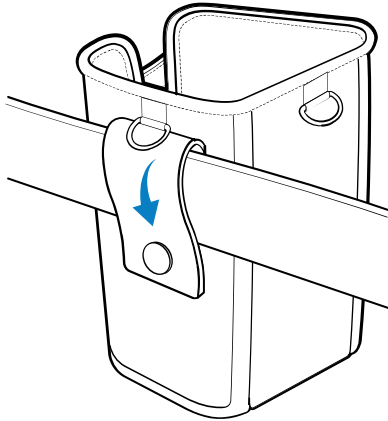

2. Slide the device into the fabric holster so that the handle fits into the cutout.

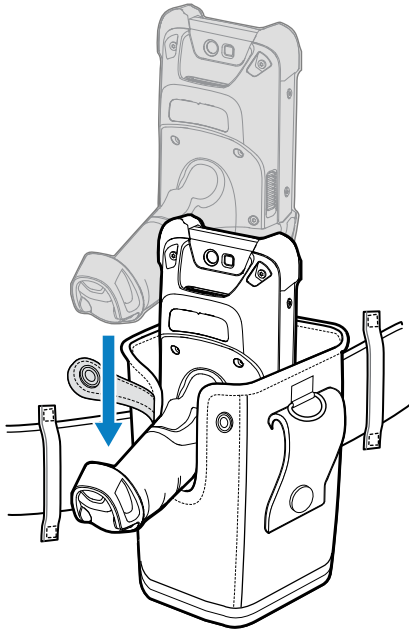

3. Snap the restraining strap above the device handle.

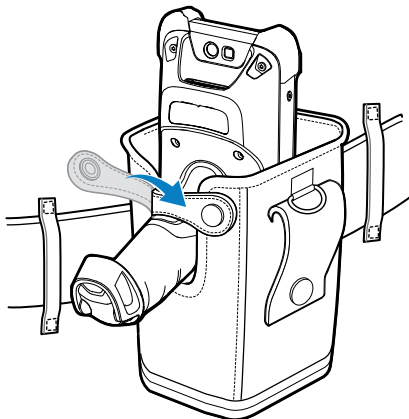

4. To remove the device, unsnap the restraining strap and then lift the device out of the fabric holster.

Using the Shoulder Strap

Attach the fabric holster to a shoulder strap.

1. Connect the clips on the shoulder strap to the rings on the fabric holster.

2. Place the shoulder strap over your head and rest on your shoulder.

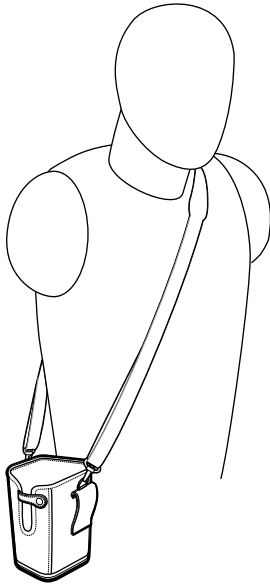

3. Lift the strap and insert the device into the holster.
4. Secure the strap to hold the device in place.

Installing the Unpowered Forklift Mount

The Unpowered Forklift Mount on a forklift allows you to place the device in a holder. The forklift mount does not provide charging or communication to the device. Install the forklift mount on a square surface or roll bar of a forklift. The mount supports portrait (vertical) orientation only.

1. Secure the RAM Clamp Base (6) to the forklift mounting surface (5) using two screws and nuts.

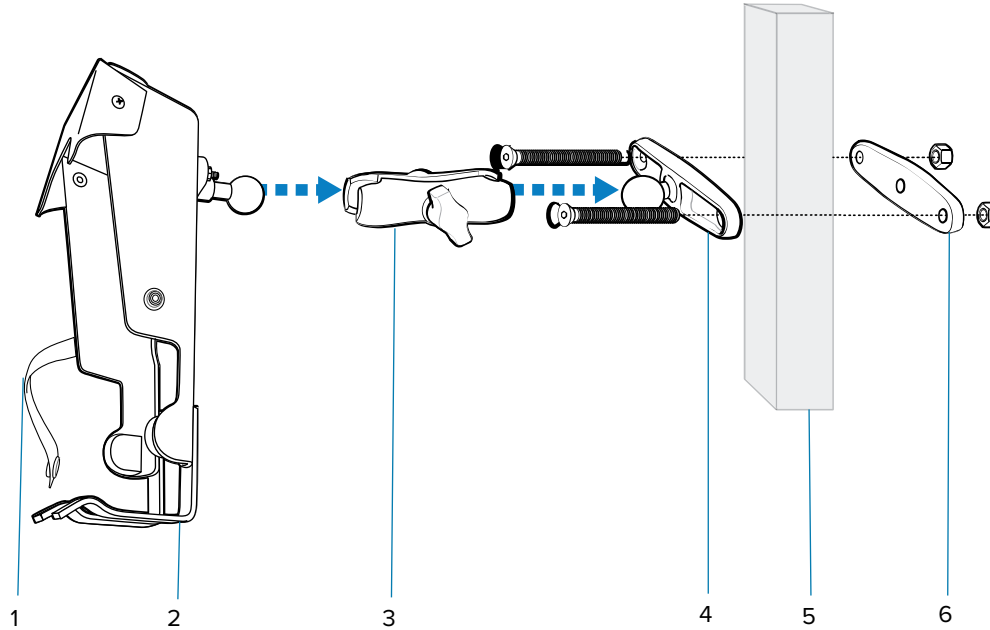

1	Rubber strap
2	Forklift Mount Holder
3	RAM Socket Arm
4	RAM Clamp Base
5	Forklift Mounting Surface
6	RAM Clamp Base

2. Attach the RAM Socket Arm (3) to the RAM Clamp Base (4) and the Forklift Mount Holder (2).
3. Turn the Socket Arm (3) hand-screw clockwise until tight.

4. Insert the device into the Forklift Mount Holder at a 45° angle in one of two ways (shown below).

Figure 36 Insert Device into Forklift Mount Holder, Rotate and Snap (Option 1)

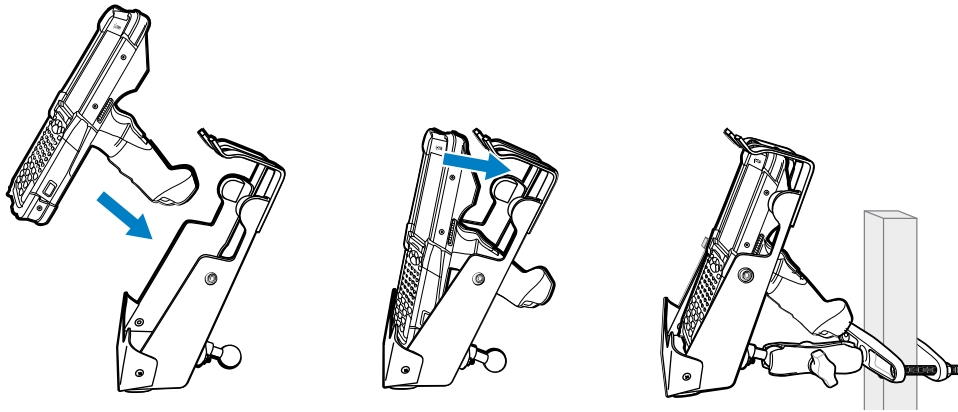
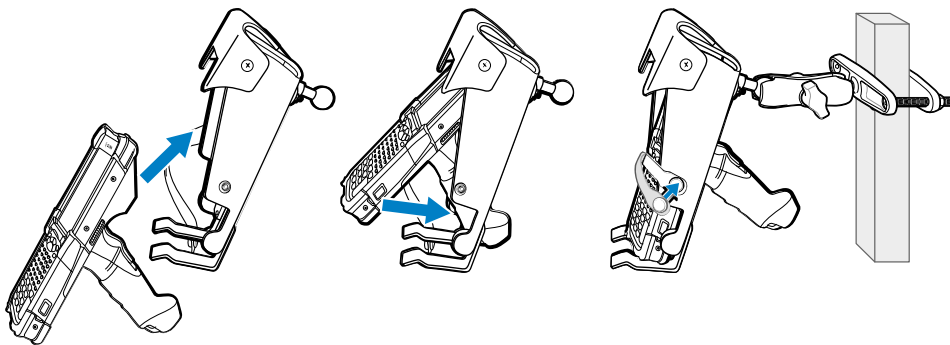

Figure 37 Insert Device into Forklift Mount Holder, Rotate and Snap (Option 2)



5. Rotate and snap the device into place.
6. If required, secure the device with the rubber strap (1), and snap it into place.



NOTE: Use the strap in this orientation for added retention of the device.

Wall Installation

Use the Rack/Wall Mount Bracket to mount battery chargers or a cradle to a wall.



IMPORTANT: For proper installation, consult a professional installer. Failure to install the bracket properly could result in damage to the hardware.

When installing the rack/wall mount bracket on a wall:

- First assemble the bottom tray, install the bottom tray on the wall, and then assemble the top tray.

- Use mounting hardware (screws and/or anchors) appropriate for the type of wall that the bracket is being mounted to.
 - The Mount Bracket mounting slot dimensions are 5 mm (0.2 in.).
 - Fasteners must be able to hold a minimum of 20 kg (44 lb).
- Install mounting brackets at the following maximum heights from the ground:
 - 5-slot cradle: 1.2 m (4 ft)
 - 4-slot battery charger: 0.91 m (3 ft)

Assembling the 4-Slot Charge Only ShareCradle Rack

Use the Rack/Wall Mount Bracket to mount a 4-slot charge only sharecradle on a rack. When installing on a rack, first assemble the bracket and cradles/chargers and then install the assembly on the rack.

Assembling the Bottom Tray

1. Place the power supply in the bottom tray.
2. Connect the AC line cord to the power supply.
3. Connect the DC line cord to the power supply.
4. Secure the power supply and cables to the bottom tray with tie wraps.



NOTE: Ensure that the tie wrap buckle is on the side of the power supply. Having the tie wrap buckle on top of the power supply interferes with the top tray.

5. Route the cables through the cable slots.

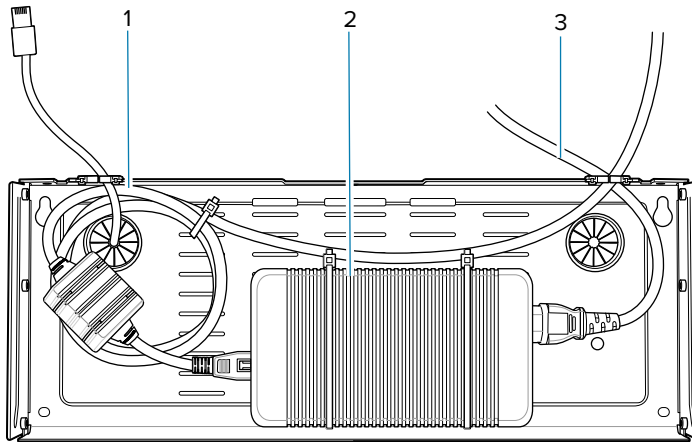

1	DC line cord
2	Power supply
3	AC line cord

Assembling the Top Tray

- Secure four M2.5 studs to the top tray as shown.

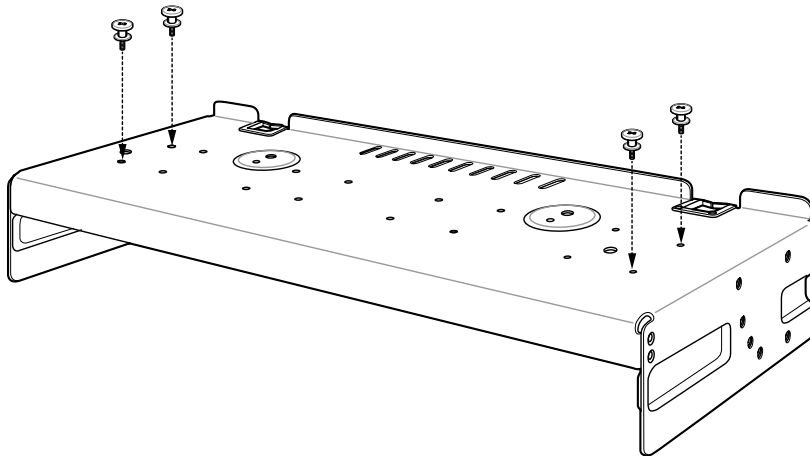

- Align and install the cradle onto the studs of the top tray.

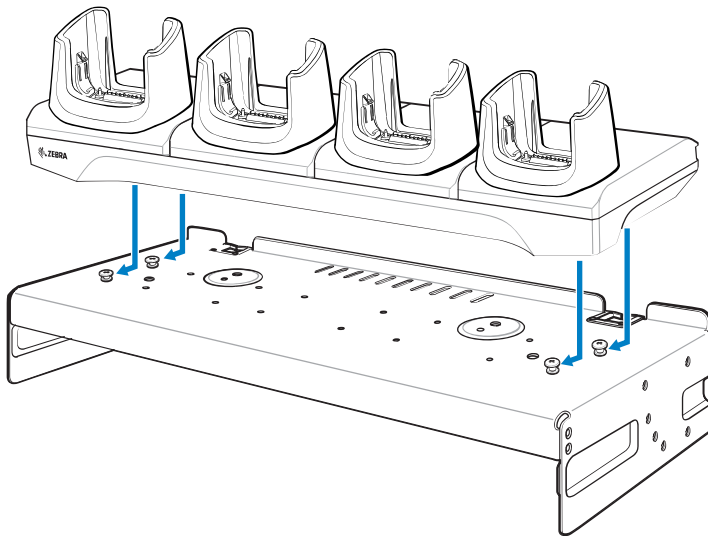

- Secure the cradle to the top tray with two M2.5 safety screws.

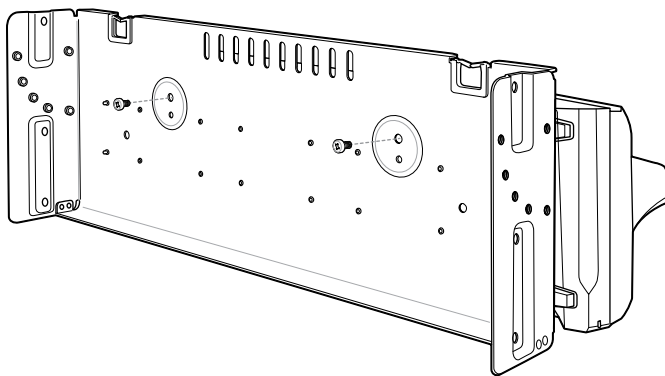

9. Slide the top tray onto the bottom tray.

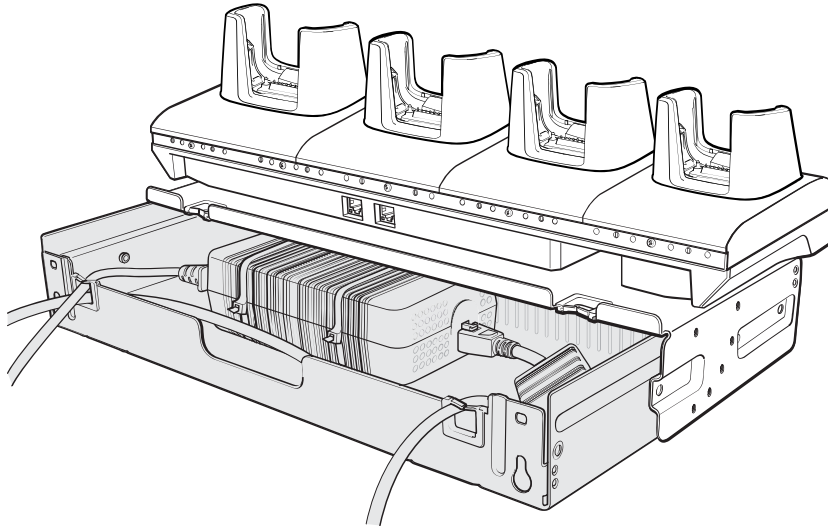

10. Connect the cables to the cradle.

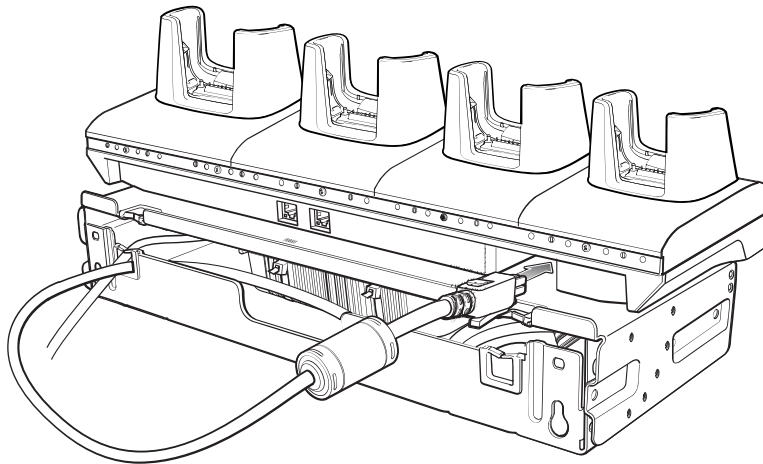

11. Secure the top tray to the bottom tray with four M5 screws (two on each side).

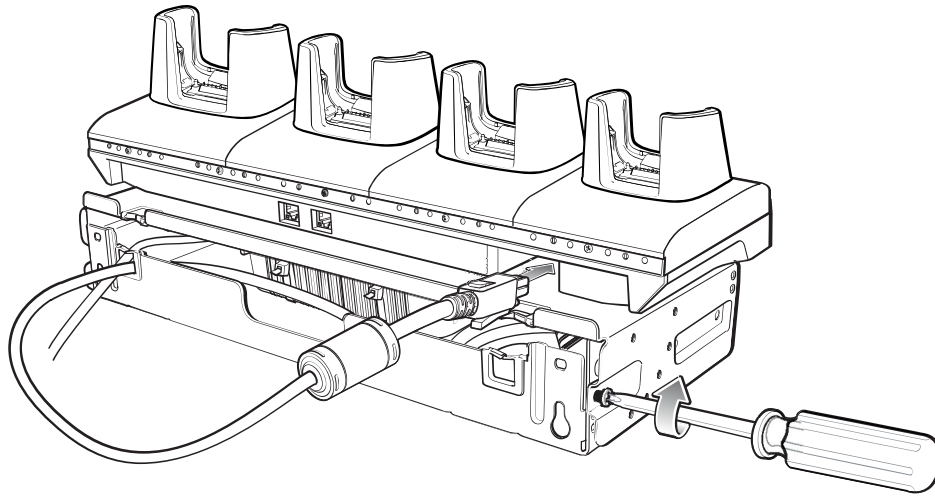

See [Installing the Cradles in a Rack Mount](#) on page 149 to install the bracket assembly onto a rack.

See [Mounting a Single Bracket to a Wall](#) on page 147 to mount the bracket assembly to a wall.

Mounting a Single Bracket to a Wall



IMPORTANT: When installing the bracket, ensure that all building codes are followed when connecting the power supplies to an AC power source.

While installing the brackets, power supplies, and cables:

- Use tie wraps to secure cables to the bracket and rails.
 - Coil cables wherever possible.
 - Route power cables along the rails.
 - Route inter-cradle cables to the side rails and then from the rails to the bracket.
1. Drill holes and install anchors according to the template supplied with the bracket.

2. Install two screws for the bottom of the bracket. The screw heads should protrude 2.5 mm (0.01") from the wall.

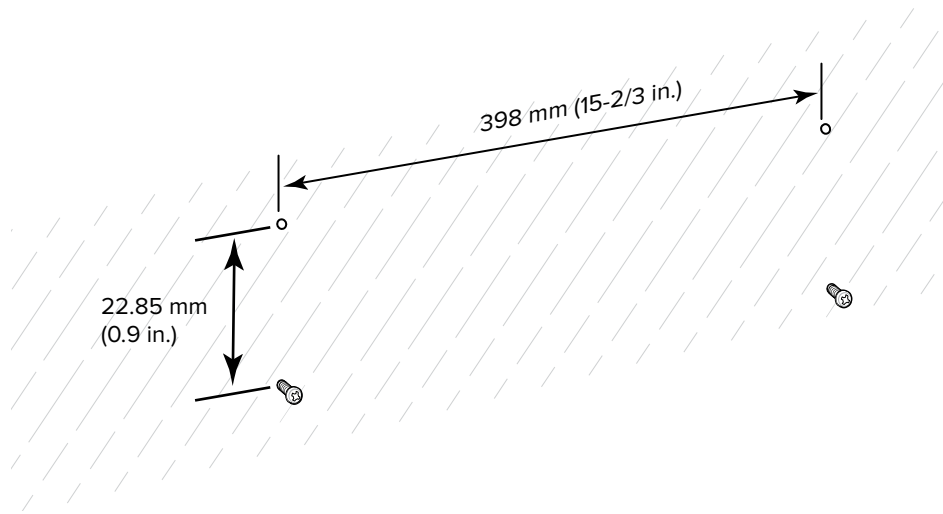

3. Align the mounting bracket's bottom mounting keyholes with the screws.
4. Hang the bracket on the screws.

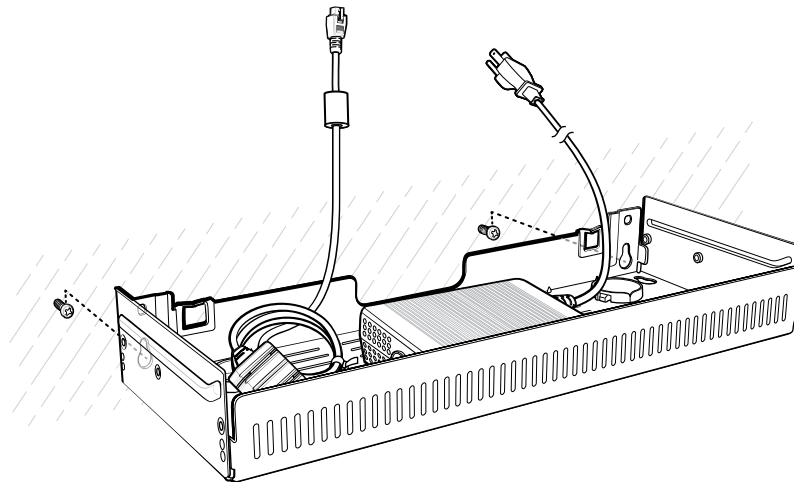

5. Install the two top screws.

6. Tighten all screws.

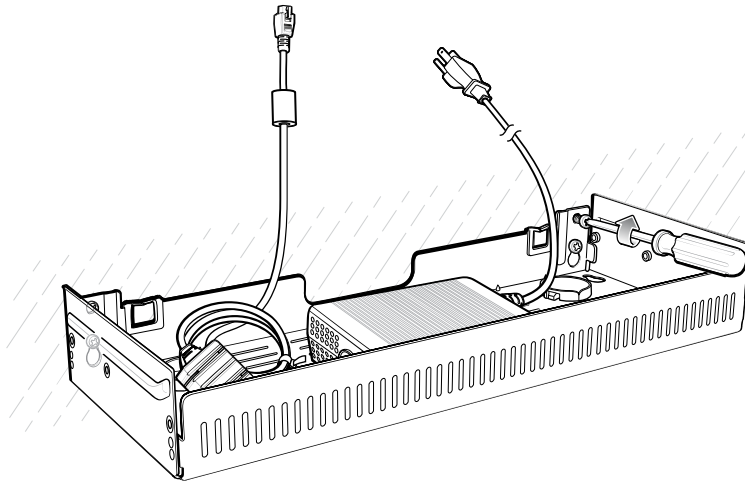

7. Add the battery chargers or cradle onto the bracket.
8. Route the cables as appropriate, and connect to a power source.

Installing the Cradles in a Rack Mount



NOTE: Use the screws provided with the rack system. Refer to the rack user documentation for instructions



IMPORTANT: When installing the rack, ensure that all building codes are followed when connecting the power supplies to an AC power source.

While installing the brackets, power supplies, and cables:

- Use tie wraps to secure cables to the bracket and rails.
- Coil cables wherever possible.
- Route power cables along the rails.
- Route inter-cradle cables to the side rails and then from the rails to the bracket.
- Install mounting brackets at the following maximum heights from the ground:
 - 5-slot cradle: 1.2 m (4 ft)
 - 4-slot battery charger: 0.91 m (3 ft)

1. Secure the mounting brackets to both sides of the top tray with four M5 screws (two on each side). For 5-slot cradles, position the flange for horizontal installation. For 4-slot battery chargers, position the flange for 25° installation.

Figure 38 Flange Horizontal Position (5-Slot Cradles)

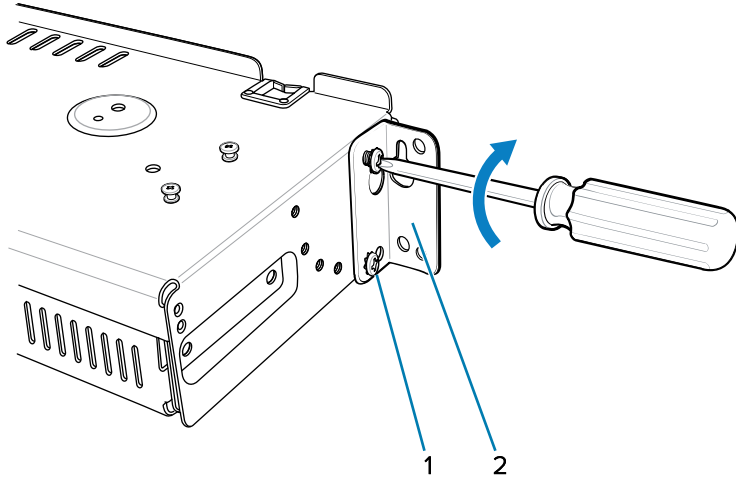

1	Fifth screw hole
2	Flange

Figure 39 Flange 25° Position (4-Slot Battery Chargers)

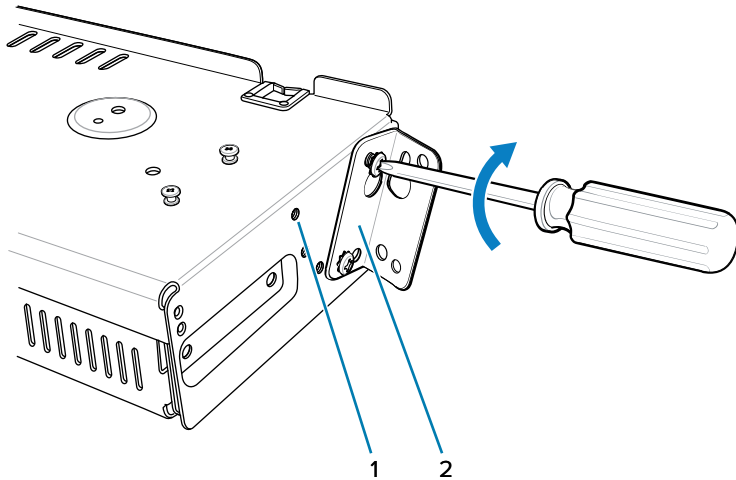

1	Top screw hole
2	Flange

- Partially install two rack system mounting screws for each mounting bracket to be installed. The screw heads should protrude halfway from the rail.

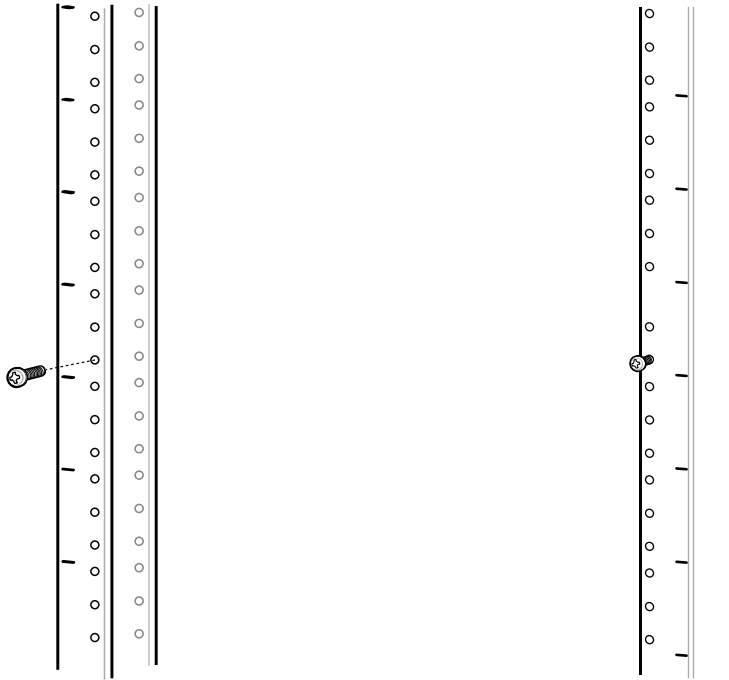

Note the following distances:

- Allow a clearance of at least 7 cm (2.75 in.) between the top of a device and the bottom of the mounting bracket above it.
- Two horizontally mounted brackets should be at least 35.6 cm (14 in.) apart vertically (from the top of one flange to the top of the next flange).
- A horizontally mounted bracket and a 25° mounted bracket should be at least 33.7 cm (16.25 in.) apart vertically (from top of one flange to the top of the next flange).

3. For each mounting bracket, align the bracket's top mounting keyholes with the screws. Place the brackets on the screws.

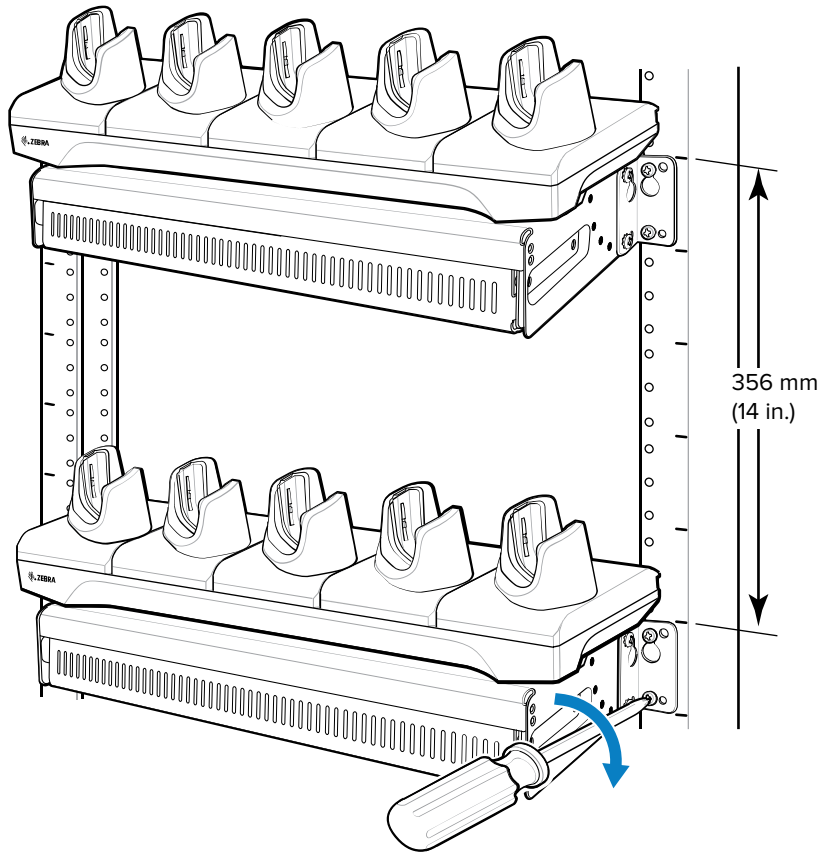

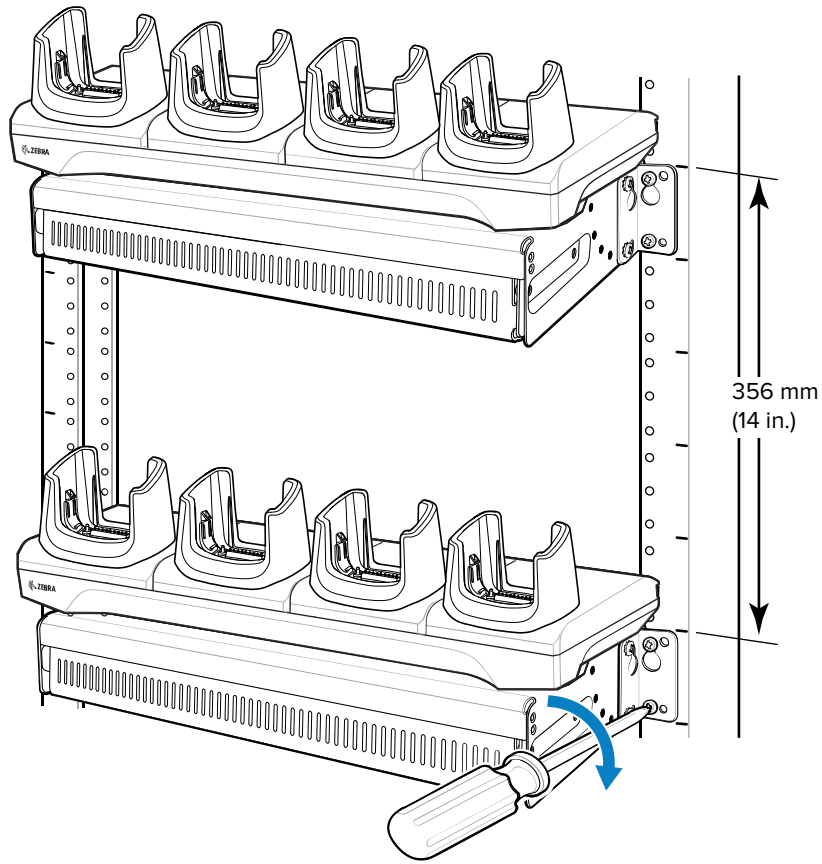

4. Tighten the top screws for each bracket.
5. Install and tighten the bottom screws to fully secure the brackets.
6. Route the cables as appropriate, and connect to a power source.

Application Deployment

This section provides steps on device security, app development, and app management. It also provides instructions for installing apps and updating the device software.



NOTE: Ensure that the date is set correctly before installing certificates or when accessing secure websites.

Security

The device implements a set of security policies that determine whether an application is allowed to run and, if allowed, with what level of trust. To develop an application, you must know the security configuration of the device, and how to sign an application with the appropriate certificate to allow the application to run (and to run with the needed level of trust).



NOTE: Ensure that the date is set correctly before installing certificates or when accessing secure websites.

Secure Certificates

If the VPN or Wi-Fi networks rely on secure certificates, obtain the certificates and store them in the device's secure credential storage, before configuring access to the VPN or Wi-Fi networks.

If downloading the certificates from a web site, set a password for the credential storage. The device supports X.509 certificates saved in PKCS#12 key store files with a .p12 extension (if key store has a .pfx or other extension, change to .p12).

The device also installs any accompanying private key or certificate authority certificates contained in the key store.

Installing a Secure Certificate

If required by the VPN or Wi-Fi network, install a secure certificate on the device.

1. Copy the certificate from the host computer to the root of the microSD card or the device's internal memory.
2. Go to **Settings**.
3. Touch **Security** > **More security settings** > **Encryption & credentials**.
4. Touch **Install a certificate**.
5. Navigate to the location of the certificate file.

6. Touch the filename of the certificate to install.
7. If prompted, enter the password for credential storage. If a password has not been set for the credential storage, enter a password for it twice, and then touch **OK**.
8. If prompted, enter the certificate's password, and then touch **OK**.
9. Enter a name for the certificate, and in the Credential use drop-down, select **VPN and apps** or **Wi-Fi**.
10. Touch **OK**.

The certificate can now be used when connecting to a secure network. For security, the certificate is deleted from the microSD card or internal memory.

Configuring Credential Storage Settings

Configure credential storage from the device settings.

1. Go to **Settings**.
2. Touch **Security > More security settings > Encryption & credentials**.
3. Select an option.
 - Touch **Trusted credentials** to display the trusted system credentials.
 - Touch **User credentials** to display user credentials.
 - Touch **Install a certificate** to install a secure certificate from the microSD card or internal storage.
 - Touch **Clear credentials** to delete all secure certificates and related credentials.

Android Development Tools

Development tools for Android include Android Studio, EMDK for Android, and StageNow.

Android Development Workstation

Android development tools are available at developer.android.com.

To start developing applications for the device, download Android Studio. Development can take place on a Microsoft® Windows®, Mac® OS X®, or Linux® operating system.

Applications are written in Java or Kotlin, but compiled and executed in the Dalvik virtual machine. Once the Java code is compiled cleanly, the developer tools make sure the application is packaged properly, including the AndroidManifest.xml file.

Android Studio contains a full featured IDE as well as SDK components required to develop Android applications.

Enabling Developer Options

The **Developer options** screen sets development-related settings. By default, the Developer Options are hidden.

1. Go to **Settings**.
2. Touch **About phone**.
3. Scroll down to **Build number**.

4. Tap **Build number** seven times.
The message **You are now a developer!** appears.
5. Touch **Back**.
6. Touch **System > Developer options**.
7. Slide the **USB debugging** switch to the **ON** position.

EMDK for Android

EMDK for Android provides developers with tools to create business applications for enterprise mobile devices. It is designed for use with Google's Android Studio and includes Android class libraries such as Barcode, sample applications with source code, and the associated documentation.

EMDK for Android allows applications to take full advantage of the capabilities that Zebra devices have to offer. It embeds Profile Manager technology within Android Studio IDE, providing a GUI-based development tool designed specifically for Zebra devices. This allows fewer lines of code, resulting in reduced development time, effort, and errors.

See Also

[For more information, go to techdocs.zebra.com.](#)

StageNow for Android

StageNow is Zebra's next-generation Android Staging Solution built on the MX platform. It allows quick and easy creation of device profiles, and can deploy to devices simply by scanning a barcode, reading a tag, or playing an audio file.

The StageNow Staging Solution includes the following components:

- The StageNow Workstation tool installs on the staging workstation (host computer) and lets the administrator easily create staging profiles for configuring device components, and perform other staging actions such as checking the condition of a target device to determine suitability for software upgrades or other activities. The StageNow Workstation stores profiles and other created content for later use.
- The StageNow Client resides on the device and provides a user interface for the staging operator to initiate staging. The operator uses one or more of the desired staging methods (print and scan a barcode, read an NFC tag or play an audio file) to deliver staging material to the device.

See Also

[For more information, go to techdocs.zebra.com.](#)

GMS Restricted

GMS Restricted mode deactivates Google Mobile Services (GMS). All GMS apps are disabled on the device and communication with Google (analytics data collection and location services) is disabled.

Use StageNow to disable or enable GMS Restricted mode. After a device is in GMS Restricted mode, enable and disable individual GMS apps and services using StageNow. To ensure GMS Restricted mode persists after an Enterprise Reset, use the Persist Manager option in StageNow.

For more information on StageNow, go to [techdocs.zebra.com](#).

ADB USB Setup

To use the ADB, install the development SDK on the host computer then install the ADB and USB drivers.

Before installing the USB driver, make sure that the development SDK is installed on the host computer. Go to developer.android.com/sdk/index.html for details on setting up the development SDK.

The ADB and USB drivers for Windows and Linux are available on the Zebra Support Central web site at zebra.com/support. Download the ADB and USB Driver Setup package. Follow the instructions with the package to install the ADB and USB drivers for Windows and Linux.

Enabling USB Debugging

By default, USB debugging is disabled.

ADB drivers must be installed on the host computer.

1. Go to **Settings**.
2. Touch **About phone**.
3. Scroll down to **Build number**.
4. Tap **Build number** seven times.
The message **You are now a developer!** appears.
5. Touch **Back**.
6. Touch **System > Developer options**.
7. Slide the **USB debugging** switch to the **ON** position.

8. Touch **OK**.

The **Allow USB debugging?** dialog box appears on the device.

9. Touch **OK**.

10. Connect the device to the host computer using the USB Charge/Com Snap-on Cup.

If the device and host computer are connected for the first time, the **Allow USB debugging?** dialog box with the **Always allow from this computer** check box displays. Select the check box, if desired, and then touch **OK**.

11. On the host computer, navigate to the **platform-tools** folder and open a command prompt window.
12. Type `adb devices`.

The following displays:

```
List of devices attached
```

```
XXXXXXXXXXXXXXXXXXXX device
```

Where XXXXXXXXXXXXXXXXXXXX is the device number.



NOTE: If the device number does not appear, ensure that ADB drivers are installed properly.

Entering Android System Recovery Mode Manually

Many of the update methods discussed in this section require putting the device into Android Recovery mode. If you are unable to enter Android Recovery mode through adb commands, use the following steps to manually enter Android Recovery mode.

1. Press and hold **Power** until the menu appears.
2. Touch **Restart**.
3. Press and hold **Trigger** until the device vibrates
The System Recovery screen appears.

Application Installation Methods

After an application is developed, install the application onto the device using one of the supported methods.

- USB connection
- Android Debug Bridge
- microSD Card
- Mobile device management (MDM) platforms that have application provisioning. Refer to the MDM software documentation for details.

Installing Applications Using the USB Connection

Use the USB connection to install applications onto the device.

1. Connect the device to a host computer using the USB Charge/Com Snap-on Cup.
2. On the device, pull down the Notification panel and touch **Charging this device via USB**.
By default, **No data transfer** is selected.
3. Touch **File Transfer**.
4. On the host computer, open a file explorer application.
5. On the host computer, copy the application APK file from the host computer to the device.



CAUTION—PRODUCT DAMAGE: Carefully follow the host computer's instructions to unmount the microSD card and disconnect USB devices correctly to avoid losing information.

6. Disconnect the device from the host computer.
7. Swipe the screen up and select  to view files on the Internal Storage.
8. Locate the application APK file.
9. Touch the application file.
10. Touch **Continue** to install the app or **Cancel** to stop the installation.
11. To confirm installation and accept what the application affects, touch **Install**. Otherwise, touch **Cancel**.
12. Touch **Open** to open the application or **Done** to exit the installation process.

The application appears in the App list.

Installing Applications Using the Android Debug Bridge

Use ADB commands to install applications onto the device.

ADB drivers must be installed on the host computer.

1. Go to **Settings**.
2. Touch **System > Developer options**.
3. Slide the **USB debugging** switch to the **ON** position.
4. Touch **OK**.

The **Allow USB debugging?** dialog box appears on the device.

5. Touch **OK**.
6. Connect the device to the host computer using the USB Charge/Com Snap-on Cup.

If the device and host computer are connected for the first time, the **Allow USB debugging?** dialog box with the **Always allow from this computer** check box displays. Select the check box, if desired, and then touch **OK**.

7. On the host computer, navigate to the **platform-tools** folder and open a command prompt window.
8. Type `adb install <application>`.
where: <application> = the path and filename of the apk file.
9. Disconnect the device from the host computer.

Installing Applications Using Wireless ADB

Use ADB commands to install an application onto the device.

Go to the Zebra Support & Downloads web site at zebra.com/support and download the appropriate file to a host computer.



IMPORTANT: Note the following:

- Ensure that the latest adb files are installed on the host computer.
- The device and the host computer must be on the same wireless network.

1. Go to **Settings**.
2. Touch **System > Developer options**.



IMPORTANT: If **Developer options** does not appear in the advanced system settings on your device, perform the steps in [Enabling Developer Options](#) on page 155.

3. Slide the **USB debugging** switch to the **ON** position.
4. At the prompt, tap **OK**.
5. Slide the **Wireless debugging** switch to the **ON** position.
 - a) If the device and host computer are connected for the first time, the **Allow wireless debugging on this network?** dialog box with the **Always allow on this network** check box displays. Select the checkbox, if desired.
 - b) Touch **ALLOW**.

6. Touch **Wireless debugging**.

The Wireless debugging screen displays.

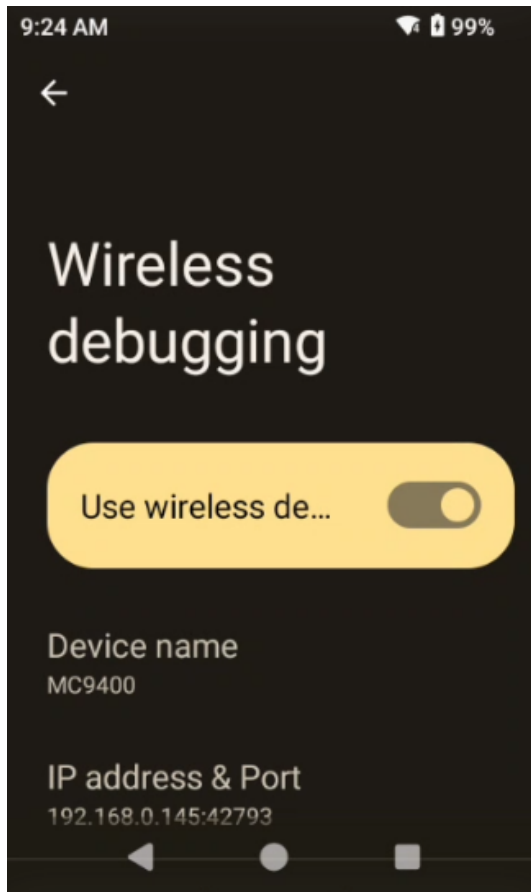

7. Note the IP address and Port on the **Wireless debugging** screen.

8. Touch **Pair device with pairing code**.

The **Pair with device** dialog box displays.

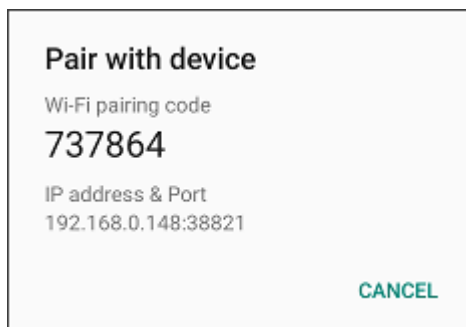

9. Note the Port on the **Pair with device** dialog box. It will be different than the one on the **Wireless debugging** screen. The IP address will be the same.

10. On the host computer, navigate to the **platform-tools** folder and open a command prompt window.

11. Type `adb pair XX.XX.XX.XX:XXXXXX`

where XX.XX.XX.XX:XXXXXX is the IP address and port number from the **Pair with device** dialog box.

12. Press **Enter**.
13. Type the pairing code from the **Pair with device** dialog box.
14. Press **Enter**.
15. Type `adb connect XX.XX.XX.XX:XXXXXX`
where `XX.XX.XX.XX:XXXXXX` is the IP address and port number from the **Wireless debugging** screen.
16. Press **Enter**.
The device is now connected to the host computer.
17. Type `adb devices`.
The following displays:

```
List of devices attached
XXXXXXXXXXXXXXXXXX device
```

Where `XXXXXXXXXXXXXXXXXX` is the device number.



NOTE: If the device number does not appear, ensure that the ADB drivers are installed properly.

18. Press **Enter**.
19. Type `adb install <file>`.
where `<file>` = the path and filename of the apk file.
20. Press **Enter**.
21. On the host computer, type `adb disconnect`.
22. Press **Enter**.



Installing Applications from a microSD Card

Use a microSD card to install applications on your device.



CAUTION—PRODUCT DAMAGE: When connecting the device to a host computer and mounting the microSD card, follow the host computer's instructions for connecting and disconnecting devices to avoid damaging the card or corrupting files.

It is strongly recommended that, prior to use, you format the microSD card on the device.

1. Copy the APK file to the root of the microSD card
 - Copy the file to the microSD card using a host computer, and then install the microSD card into the device (go to [Installing a microSD Card](#) for instructions).
 - Connect the device (with the microSD card installed) to the host computer, copy the file to the microSD card, and then disconnect the device from the host computer.
2. Press and hold **Power** to turn on the device.
3. Swipe the screen up and select  to view files on the microSD card.
4. Touch  **SD card**.
5. Locate the application APK file.

6. Touch the application file.
7. Touch **Continue** to install the app or **Cancel** to stop the installation.
8. To confirm installation and accept what the application affects, touch **Install**. Otherwise, touch **Cancel**.
9. Touch **Open** to open the application or **Done** to exit the installation process.

The application appears in the App list.

Uninstalling an Application

Free up device memory by removing unused apps.

1. Go to **Settings**.
2. Touch **Apps**.
3. Touch **See all apps** to view all applications in the list.
4. Scroll to the application to uninstall.
5. Touch the app.

The **App info** screen for that application appears.

6. Touch **UNINSTALL**.
7. Touch **OK** to confirm.

Android System Update

System Update packages can contain either partial or complete updates for the operating system. Zebra distributes the System Update packages on the Zebra Support & Downloads website. Perform a system update using either a microSD card or using ADB.

Performing a System Update Using a microSD Card

It is strongly recommended that, prior to use, you format the microSD card on the device.

Go to the Zebra Support & Downloads web site at zebra.com/support and download the appropriate System Update package to a host computer.

1. Copy the System Update ZIP file to the root of the microSD card.
 - Copy the file to the microSD card using a host computer, and then install the microSD card into the device (go to [Installing a microSD Card](#) for instructions).
 - Connect the device (with the microSD card installed) to the host computer, copy the file to the microSD card, and then disconnect the device from the host computer.
2. Press and hold **Power** until the menu appears.
3. Touch **Restart**.
4. Press and hold the **Trigger** until the device vibrates.

The System Recovery screen appears.
5. Press **Up** and **Down** to navigate to **Apply upgrade from SD card**.
6. Press **Enter**.

7. Use **Up** and **Down** to navigate to **Full OTA Package** or **Diff OTA Package**.
8. Press **Enter**.
9. Press **Up Arrow** and **Down Arrow** to navigate to the System Update file.
10. Press **Power**.
The System Update installs, and then the device returns to the Recovery screen.
11. Press **Power** to reboot the device.

Performing a System Update Using ADB

Use ADB to perform a system update.

Go to the Zebra Support & Downloads web site at zebra.com/support and download the appropriate System Update package to a host computer.

1. Connect the device to a host computer using the USB Charge/Com Snap-on Cup.
2. Go to **Settings**.
3. Touch **System > Developer options**.
4. Slide the **USB debugging** switch to the **ON** position.
5. If the device and host computer are connected for the first time, the **Allow USB debugging?** dialog box with the **Always allow from this computer** check box displays. Select the checkbox if desired.
6. Touch **OK**.
7. On the host computer, navigate to the **platform-tools** folder and open a command prompt window.
8. Type `adb devices`.



NOTE: If the device number does not appear, ensure that the ADB drivers are installed properly.

9. Type `adb reboot recovery`.
10. Press **Enter**.
The System Recovery screen appears on the device.
11. Press **Up** and **Down** to navigate to **Apply upgrade from ADB**.
12. Press **Power**.
13. Use **Up** and **Down** to navigate to **Full OTA Package** or **Diff OTA Package**.
14. Press **Power**.
15. On the host computer command prompt window, type `adb sideload <file>`.
where: <file> = the path and filename of the zip file.
16. Press **Enter**.
The System Update installs (progress appears as a percentage in the Command Prompt window) and then the System Recovery screen appears on the device.
17. Press **Power** to reboot the device.
18. Disconnect the USB cable from the device.

Verifying System Update Installation

Verify that the system update was successful.

1. Go to **Settings**.
2. Touch **About phone**.
3. Scroll down to **Build number**.
4. Ensure that the build number matches the new system update package file number.

Android Enterprise Reset

An Enterprise Reset erases all user data in the /data partition, including data in the primary storage locations (/sdcard and emulated storage), while preserving the contents of the /enterprise folder and its subfolders. The contents of the /enterprise folder and its subfolders are preserved. Zebra distributes the Enterprise Reset packages on the Zebra Support & Downloads website.

Before performing an Enterprise Reset, provision all necessary configuration files and restore after the reset.

Performing an Enterprise Reset From Device Settings

Perform an Enterprise Reset from the device settings.

1. Go to **Settings**.
2. Touch **System > Reset Options > Erase all data (enterprise reset)**.
3. Touch **Erase all data** twice to confirm the Enterprise Reset.

Performing an Enterprise Reset Using a microSD Card

It is strongly recommended that, prior to use, you format the microSD card on the device.

Go to the Zebra Support & Downloads web site at zebra.com/support and download the appropriate Enterprise Reset file to a host computer.

1. Copy the Enterprise Reset ZIP file to the root of the microSD card.
 - Copy the file to the microSD card using a host computer, and then install the microSD card into the device (go to [Installing a microSD Card](#) for instructions).
 - Connect the device (with the microSD card installed) to the host computer, copy the file to the microSD card, and then disconnect the device from the host computer.
2. Press and hold **Power** until the menu appears.
3. Touch **Restart**.
4. Press and hold **Trigger** until the device vibrates.

The System Recovery screen appears.
5. Press **Up** and **Down** to navigate to **Apply upgrade from SD card**.
6. Press **Enter**.
7. Use **Up** and **Down** to navigate to **Full OTA Package**.
8. Press **Enter**.

9. Use **Up** and **Down** to navigate to the Enterprise Reset file.
10. Press **Power**.
The Enterprise Reset occurs, and then the device returns to the Recovery screen.
11. Press **Power** to reboot the device.

Performing an Enterprise Reset Using ADB

Perform an Enterprise Reset using ADB.

1. Connect the device to a host computer using the USB Charge/Com Snap-on Cup.
2. Go to **Settings**.
3. Touch **System > Developer options**.
4. Slide the **USB debugging** switch to the **ON** position.
5. If the device and host computer are connected for the first time, the **Allow USB debugging?** dialog box with the **Always allow from this computer** check box displays. Select the check box, if required.
6. Touch **OK** or **Allow**.
7. On the host computer, navigate to the **platform-tools** folder and open a command prompt window.
8. Press **Enter**.
The System Recovery screen appears on the device.
9. Press **Up** and **Down** to navigate to **Apply upgrade from ADB**.



NOTE: If you are not able to enter Android Recovery mode through the adb command, go to [Entering Android System Recovery Mode Manually](#).

10. Press **Up** and **Down** to navigate to **Apply upgrade from ADB**.
11. Press **Power**.
12. Use **Up** and **Down** to navigate to **Full OTA Package**.
13. Press **Power**.
14. On the host computer command prompt window type `adb sideload <file>`
where: <file> = the path and filename of the zip file.
15. Press **Enter**.
The Enterprise Reset package installs, and then the System Recovery screen appears on the device.
16. Press **Power** to reboot the device.

Android Factory Reset

A Factory Reset erases all data in the /data and /enterprise partitions in internal storage and clears all device settings. A Factory Reset returns the device to the last installed operating system image. To revert to a previous operating system version, re-install that operating system image. Zebra distributes the Factory Reset packages on the Zebra Support & Downloads website.

Performing a Factory Reset Using a microSD Card

Perform a Factory Reset using a microSD card.

Go to the Zebra Support & Downloads web site at zebra.com/support and download the appropriate Factory Reset file to a host computer.

1. Copy the Factory Reset zip file to the root of the microSD card.
 - Copy the file to the microSD card using a host computer, and then install the microSD card into the device (go to [Installing a microSD Card](#) for instructions).
 - Connect the device (with the microSD card installed) to the host computer, copy the file to the microSD card, and then disconnect the device from the host computer.
2. Press and hold **Power** until the menu appears.
3. Touch **Restart**.
4. Press and hold **Trigger** until the device vibrates.
The System Recovery screen appears.
5. Press **Up** and **Down** to navigate to **Apply upgrade from SD card**.
6. Press **Power**.
7. Press **Up Arrow** and **Down Arrow** to navigate to **Full OTA Package**.
8. Press **Power**.
9. Press **Up Arrow** and **Down Arrow** to navigate to the Factory Reset file.
10. Press **Power**.
The Factory Reset occurs, and then the device returns to the Recovery screen.
11. Press **Power** to reboot the device.

Performing a Factory Reset Using ADB

Perform a Factory Reset using ADB.

Go to the Zebra Support & Downloads web site at zebra.com/support and download the appropriate Factory Reset file to a host computer.

1. Connect the device to a host computer using the USB Charge/Com Snap-on Cup.
2. Go to **Settings**.
3. Touch **System** > **Developer options**.
4. Slide the **USB debugging** switch to the **ON** position.
5. If the device and host computer are connected for the first time, the **Allow USB debugging?** dialog box with the **Always allow from this computer** check box displays. Select the check box, if required.
6. Touch **OK**.
7. Type:
`adb reboot recovery`
8. Press **Enter**.
The System Recovery screen appears on the device.

9. Press **Up** and **Down** to navigate to **Apply upgrade from ADB**.
10. Press **Power**.
11. Use **Up** and **Down** to navigate to **Full OTA Package**.
12. Press **Power**.
13. On the host computer command prompt window type `adb sideload <file>`.
where: <file> = the path and filename of the zip file.
14. Press **Enter**.
The Factory Reset package installs, and then the System Recovery screen appears on the device.
15. Press **Power** to reboot the device.

Android Storage

The device contains multiple types of file storage.

- Random Access Memory (RAM)
- Internal storage
- External storage (microSD card)
- Enterprise folder.

Random Access Memory

Executing programs use RAM to store data. Data stored in RAM is lost upon a reset.

The operating system manages how applications use RAM. It only allows applications and component processes and services to use RAM when required. It may cache recently used processes in RAM, so they restart more quickly when opened again, but it will erase the cache if it needs the RAM for new activities.

The screen displays the amount of used and free RAM.

- **Performance** - Indicates memory performance.
- **Total memory** - Indicates the total amount of RAM available.
- **Average used (%)** - Indicates the average amount of memory (as a percentage) used during the period of time selected (default - 3 hours).
- **Free** - Indicates the total amount of unused RAM.
- **Memory used by apps** - Touch to view RAM usage by individual apps.

Viewing Memory

View the amount of memory used and free RAM.

1. Go to **Settings**.
2. Touch **System > Advanced > Developer options**.
3. Touch **Memory**.

Internal Storage

The device has internal storage. The internal storage content can be viewed and files copied to and from when the device is connected to a host computer. Some applications are designed to be stored on the internal storage rather than in internal memory.

Viewing Internal Storage

View available and used internal storage on the device.

1. Go to **Settings**.
2. Touch **Storage**.

Internal Storage displays the total amount of space on internal storage and amount used.

If the device has removable storage installed, touch **Internal shared storage** to display the amount of internal storage used by apps, photos, videos, audio, and other files.

External Storage

The device can have a removable microSD card. The microSD card content can be viewed and files copied to and from when the device is connected to a host computer.



Viewing External Storage

Portable storage displays the total amount of space on the installed microSD card or USB drive and the amount used.

1. Go to **Settings**.
2. Touch **Storage**.

Touch **General USB Drive** to view the contents of the card.

Touch **SD card** to view the contents of the card.

3. To unmount the microSD card, touch .
4. To unmount the USB drive, touch .

Formatting a microSD Card as Portable Storage

Format a microSD card as portable storage for the device.

1. Touch **SD card**.
2. Touch  > **Storage settings**.
3. Touch **Format**.
4. Touch **ERASE & FORMAT**.
5. Touch **DONE**.

Formatting a microSD Card as Internal Memory

You can format a microSD card as internal memory to increase the actual amount of the device's internal memory. Once formatted, the microSD card can only be read by this device.



NOTE: The suggested maximum SD card size is 128 GB when using internal storage.

1. Touch **SD card**.
2. Touch **⋮** > **Storage settings**.
3. Touch **Format as internal**.
4. Touch **ERASE & FORMAT**.
5. Touch **DONE**.

Enterprise Folder

The Enterprise folder (within internal flash) is a super-persistent storage that is persistent after a reset and an Enterprise Reset.

The Enterprise folder is erased during a Factory Reset. The Enterprise folder is used for deployment and device-unique data. The Enterprise folder is approximately 128 MB (formatted). Applications can persist data after an Enterprise Reset by saving data to the enterprise/user folder. The folder is ext4 formatted and is only accessible from a host computer using ADB or from an MDM.

Managing Apps

Apps use two kinds of memory: storage memory and RAM. Apps use storage memory for themselves and any files, settings, and other data they use. They also use RAM when they are running.

1. Go to **Settings**.
2. Touch **Apps & notifications**.
3. Touch **See all XX apps** to view all apps on the device.
4. Touch **⋮** > **Show system** to include system processes in the list.
5. Touch an app, process, or service in the list to open a screen with details about it and, depending on the item, to change its settings, permissions, notifications and to force stop or uninstall it.

App Details



Apps have different kinds of information and controls.

- **Force stop** - Stop an app.
- **Disable** - Disable an app.
- **Uninstall** - Remove the app and all of its data and settings from the device.
- **Notifications** - Set the app notification settings.
- **Permissions** - Lists the areas on the device that the app has access to.
- **Storage & cache** - Lists how much information is stored and includes buttons for clearing it.
- **Mobile data & Wi-Fi** - Provides information about data consumed by an app.

- **Advanced**
 - **Screen time** - Displays the amount of time the app has displayed on the screen.
 - **Battery** - Lists the amount of computing power used by the app.
 - **Open by default** - If you have configured an app to launch certain file types by default, you can clear that setting here.
 - **Display over other apps** - Allows an app to display on top of other apps.
 - **App details** - Provides a link to additional app details on the Play store.
 - **Additional settings in the app** - Opens settings in the app.
 - **Modify system settings** - Allows an app to modify the system settings.

Managing Downloads

Files and apps downloaded using the Browser or Email are stored on the USB drive or Internal storage in the Download directory. Use the Downloads app to view, open, or delete downloaded items. Files and apps downloaded using the Browser or Email are stored on the microSD card or Internal storage in the Download directory. Use the Downloads app to view, open, or delete downloaded items.

1. Swipe the screen up and touch .
2. Touch  > **Downloads**.
3. Touch and hold an item, select items to delete and touch . The item is deleted from the device.

Keypads

To support specialized applications, you can change the modular keypads in the field when required.

The device has the following interchangeable modular keypads:

- 58-key Alpha Numeric Function keypad
- 53-key Standard keypad
- 53-key IBM-5250 Emulator keypad
- 53-key VT Emulator keypad
- 43-key Shifted Alpha keypad
- 34-key Numeric keypad
- 29-key Shifted Alpha keypad.

Removing and Replacing Keypads

1. Power off the device.
2. Remove the battery.
3. Using a long, thin  T8 screwdriver, remove the two screws and washers from inside the battery slot.

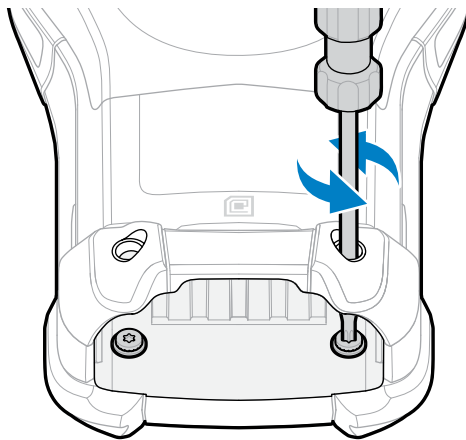

4. Turn the device over so that the keypad is visible.

Keypads

5. Using a  T8 screwdriver, remove the two keypad assembly screws from the top of the keypad.

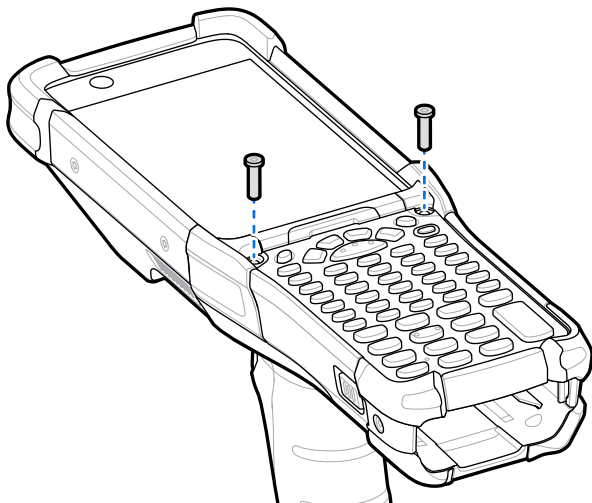

6. Lift the keypad from the device.
7. Align the new keypad along the bottom ridge of the device, and then lay it flat.

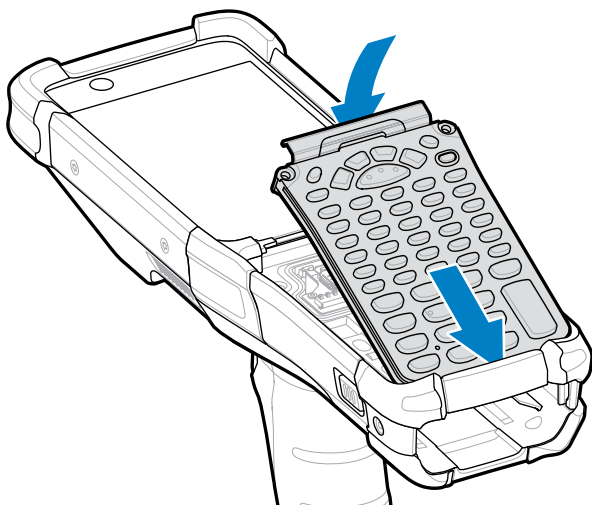

8. Using a  T8 screwdriver, secure the keypad to the device using the two screws. Torque the screws to 5.8 kgf-cm (5.0 lbf-in).

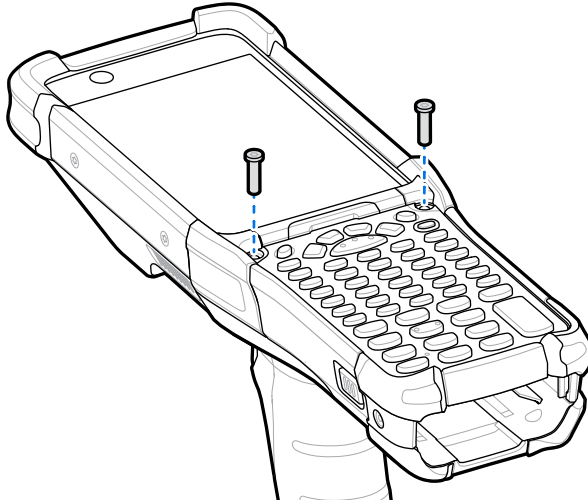

9. Turn the device over.
10. Using a long, thin  T8 screwdriver, replace the two screws and washers inside the battery slot and torque to 5.8 kgf-cm (5.0 lbf-in).

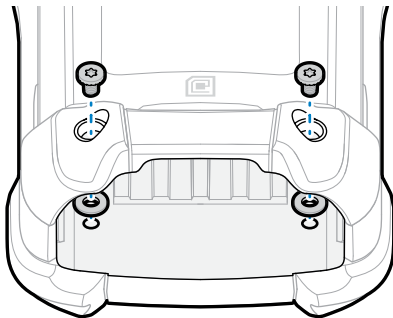

11. Insert the battery.
12. Press and hold **Power** to power on the device.

58-Keys Alpha Numeric Function Keypad

The 58-key keypad contains a Power button, application keys, scroll keys, and function keys. The keypad is color-coded to indicate the alternate function key (blue) values.



NOTE: Note that keypad functions can be changed by an application, so the keypad may not function exactly as described. See [Special Characters](#) on page 197 for key and button details and [Keypad Special Functions](#) on page 196 for the keypad's various functions.

Figure 40 58-Keys Alpha Numeric Function Keypad

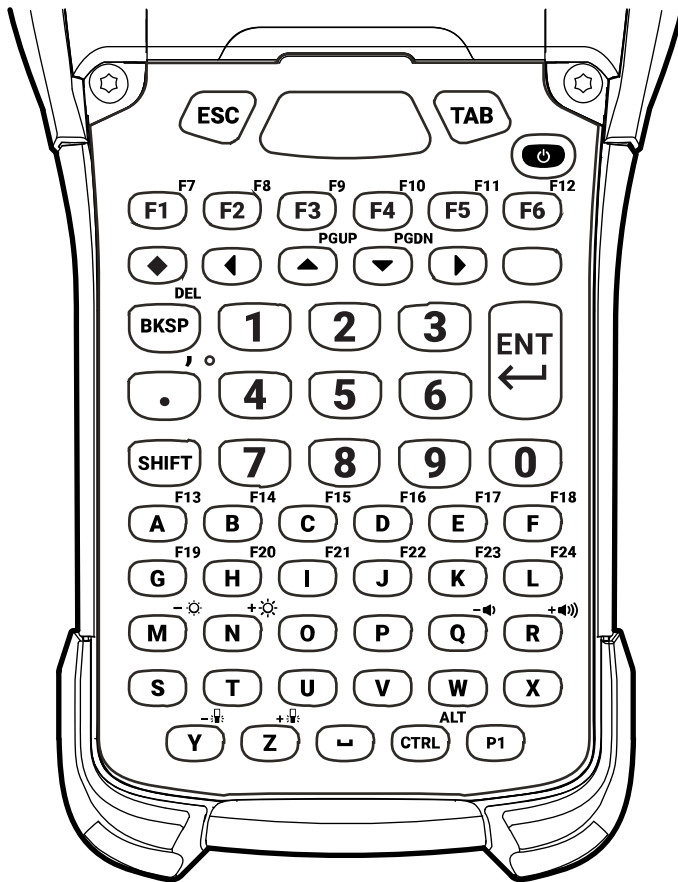

Table 24 58-Key Alpha Numeric Function Keypad Key Descriptions





Key	Description
Power (Red) 	Turns the device on and off. Performs a warm boot and a hard reset. For more information, see Resetting the Device .
P1 	User-programmable key. By default, P1 is the dedicated PTT key.
Scan (Green) 	Activates the scanner/imager in a scan-enabled application.
ESC 	Exits the current operation.

Table 24 58-Key Alpha Numeric Function Keypad Key Descriptions (Continued)





















Key	Description
TAB 	Tab function.
Up/Down 	Moves up and down from one item to another.
Left/Right 	Moves left and right from one item to another.
Alpha 	Use the alpha keys for alphabetic characters.
BKSP <small>DEL</small> 	Backspace function.
SPACE 	Space function.
Numeric/Application 	The numeric keys generate keycodes 0 to 9.
Function (Blue) 	<p>Press and release the blue function key to activate the keypad alternate functions (shown on the keypad in Blue).</p> <ol style="list-style-type: none"> 1. Press the Blue function key once to put the keyboard into one-shot mode. The  icon appears on the Status bar. 2. Press the Blue function key again. The keypad is locked in function mode, and the  icon appears in the Status bar. 3. Press and release the Blue function key a third time to return to the default keypad functions. The  icon clears. <p>Press the blue function key and SHIFT to activate CAPSLOCK mode. The  icon appears.</p>

Table 24 58-Key Alpha Numeric Function Keypad Key Descriptions (Continued)

Key	Description
CTRL ALT 	Press and release the CTRL key to activate the keypad alternate CTRL functions. The C icon appears in the status bar. Press the Blue function key followed by the CTRL key to activate the keypad alternate ALT functions. The A icon appears in the status bar.
SHIFT 	Press and release the SHIFT key to activate the keypad alternate SHIFT functions. <ol style="list-style-type: none"> Press the SHIFT key once to put the keyboard into Shift mode. The  icon appears in the status bar. After you press another key, the keypad returns to the non-shift state. Press and release the SHIFT key twice to enable the Shift Lock state. The  icon appears in the status bar. Press and release the SHIFT key again to disable the Shift Lock state. The  icon clears.
Period/Decimal Point 	Produces a period for alpha entries and a decimal point for numeric entries.
Diamond 	Provides a 3x3 matrix on the screen with nine additional symbols. With a single tap, you can select via touch input or the keyboard, 1-9 numerical keys. Double tapping the Diamond key locks the 3x3 grid, and you can select multiple keys. Pressing the Diamond key a third time closes the 3x3 matrix. You can modify the symbols in the 3x3 matrix using the StageNow utility in the KeyMappingMgr settings.  <p>This is the default symbol layout for this keyboard.</p>
Enter 	Executes a selected item or function.

53-Keys Standard Keypad

The 53-key keypad contains a Power button, application keys, scroll keys, and function keys. The keypad is color-coded to indicate the alternate function key (blue) values.



NOTE: Note that keypad functions can be changed by an application, so the keypad may not function exactly as described. See [Special Characters](#) on page 197 for key and button details and [Keypad Special Functions](#) on page 196 for the keypad’s various functions.

Figure 41 53-Keys Standard Keypad

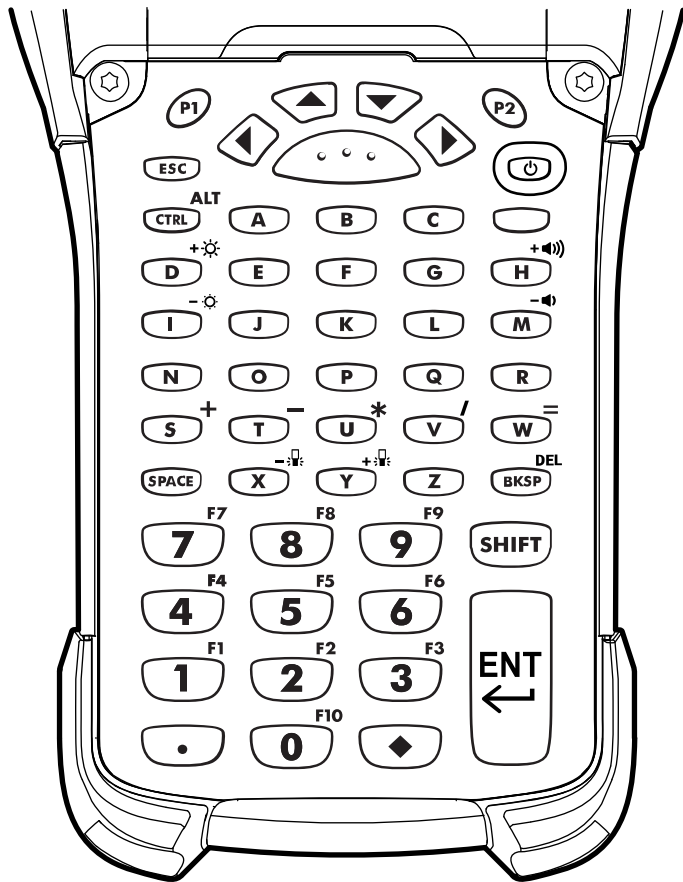

Table 25 53-Key Standard Keypad Key Descriptions



Key	Description
Power (Red) 	Turns the device on and off. Performs a warm boot and a hard reset. For more information, see Resetting the Device .
P1/P2  	User-programmable keys: <ul style="list-style-type: none"> • By default, P1 is the dedicated PTT key. • By default, P2 acts like another Scan key.

Table 25 53-Key Standard Keypad Key Descriptions (Continued)























Key	Description
Scan (Yellow) 	Activates the scanner/imager in a scan-enabled application.
Up/Down  	Moves up and down from one item to another.
Left/Right  	Moves left and right from one item to another.
ESC 	Exits the current operation.
Alpha 	Use the alpha keys for alphabetic characters.
SPACE/BKSP 	Space and backspace functions.
Numeric/Application 	The numeric keys generate keycodes 0 to 9.
Function (Blue) 	<p>Press and release the blue function key to activate the keypad alternate functions (shown on the keypad in Blue).</p> <ol style="list-style-type: none"> 1. Press the Blue function key once to put the keyboard into one-shot mode. The  icon appears on the Status bar. 2. Press the Blue function key again. The keypad is locked in function mode, and the  icon appears in the Status bar. 3. Press and release the Blue function key a third time to return to the default keypad functions. The  icon clears. <p>Press the blue function key and SHIFT to activate CAPSLOCK mode. The  icon appears.</p>

Table 25 53-Key Standard Keypad Key Descriptions (Continued)

Key	Description																		
Control ALT 	Press and release the CTRL key to activate the keypad alternate CTRL functions. The C icon appears in the status bar. Press the Blue key followed by the CTRL key to activate the keypad alternate ALT functions. The A icon appears in the status bar.																		
Shift 	Press and release the SHIFT key to activate the keypad alternate SHIFT functions. <ol style="list-style-type: none"> Press the SHIFT key once to put the keyboard into Shift mode. The  icon appears in the status bar. After you press another key, the keypad returns to the non-shift state. Press and release the SHIFT key twice to enable the Shift Lock state. The  icon appears in the status bar. Press and release the SHIFT key again to disable the Shift Lock state. The  icon clears. 																		
Period/Decimal Point 	Produces a period for alpha entries and a decimal point for numeric entries.																		
Diamond 	Provides a 3x3 matrix on the screen with nine additional symbols. With a single tap you can select via touch input or the keyboard, 1-9 numerical keys. Double tapping the Diamond key locks the 3x3 grid, and you can select multiple keys. Pressing the Diamond key a third time closes the 3x3 matrix. You can modify the symbols in the 3x3 matrix using the StageNow utility in the KeyMappingMgr settings. <div style="text-align: center; margin: 10px 0;"> <table border="1" style="border-collapse: collapse; width: 150px; height: 150px;"> <tr> <td style="text-align: center;">7</td> <td style="text-align: center;">8</td> <td style="text-align: center;">9</td> </tr> <tr> <td style="text-align: center;"> </td> <td style="text-align: center;">[</td> <td style="text-align: center;">]</td> </tr> <tr> <td style="text-align: center;">4</td> <td style="text-align: center;">5</td> <td style="text-align: center;">6</td> </tr> <tr> <td style="text-align: center;">£</td> <td style="text-align: center;">:</td> <td style="text-align: center;">€</td> </tr> <tr> <td style="text-align: center;">1</td> <td style="text-align: center;">2</td> <td style="text-align: center;">3</td> </tr> <tr> <td style="text-align: center;">~</td> <td style="text-align: center;">@</td> <td style="text-align: center;">-</td> </tr> </table> </div> This is the default symbol layout for this keyboard.	7	8	9		[]	4	5	6	£	:	€	1	2	3	~	@	-
7	8	9																	
	[]																	
4	5	6																	
£	:	€																	
1	2	3																	
~	@	-																	
Enter 	Executes a selected item or function.																		

53-Keys IBM-5250 Emulator Keypad

The IBM-5250 emulator keypad contains a Power button, application keys, scroll keys, and a function key. The keypad is color-coded to indicate the alternate function key (blue) values.



NOTE: Note that keypad functions can be changed by an application, so the keypad may not function exactly as described. See [Special Characters](#) on page 197 for key and button details and [Keypad Special Functions](#) on page 196 for the keypad’s various functions.

Figure 42 53-Keys IBM-5250 Emulator Keypad

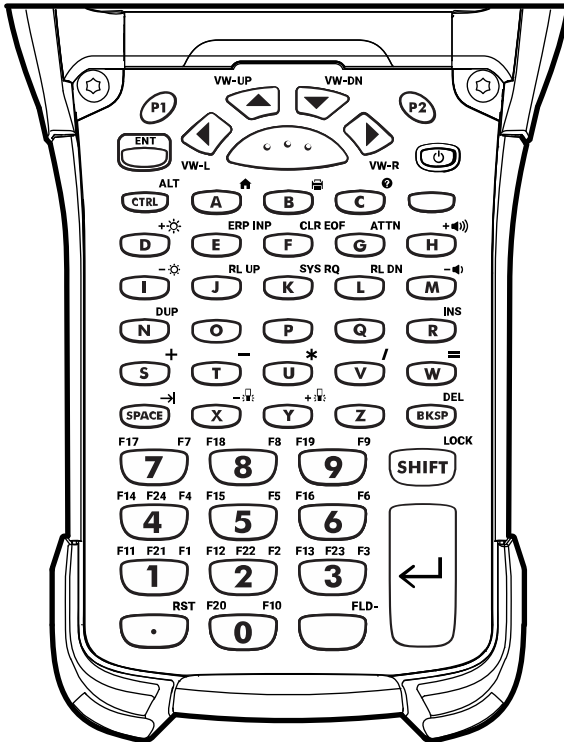

NOTE: The IBM-5250 emulator configuration is only used when the device is running the 5250 emulation software.

Table 26 IBM-5250 Emulator Descriptions



Key	Description
<p>Power (Red)</p> 	<p>Turns the device on and off. Performs a warm boot and a hard reset. For more information, see Resetting the Device.</p>
<p>P1/P2</p> 	<p>User-programmable keys:</p> <ul style="list-style-type: none"> • By default, P1 is the dedicated PTT key. • By default, P2 acts like another Scan key.

Table 26 IBM-5250 Emulator Descriptions (Continued)





















Key	Description
<p>Scan (Yellow)</p> 	<p>Activates the scanner/imager in a scan-enabled application.</p>
<p>Up/Down</p> 	<p>Moves up and down from one item to another.</p>
<p>Left/Right</p> 	<p>Moves left and right from one item to another.</p>
<p>ENT</p> 	<p>The enter key.</p>
<p>Alpha</p> 	<p>Use the alpha keys for alphabetic characters.</p>
<p>SPACE/BKSP</p> 	<p>Space and backspace functions.</p>
<p>Application</p> 	<p>The numeric keys generate keycodes 0 to 9.</p>
<p>Function (Blue)</p> 	<p>Press and release the Blue function key to activate the keypad alternate functions (shown on the keypad in Blue).</p> <ol style="list-style-type: none"> 1. Press the Blue function key once to put the keyboard into one-shot mode. The  icon appears on the Status bar. 2. Press the Blue function key again. The keypad is locked in function mode, and the  icon appears in the Status bar. 3. Press and release the Blue function key a third time to return to the default keypad functions. The  icon clears. <p>Press the blue function key and SHIFT to activate CAPSLOCK mode. The  icon appears.</p>

Table 26 IBM-5250 Emulator Descriptions (Continued)

Key	Description																		
CTRL ALT 	Press and release the CTRL key to activate the keypad alternate CTRL functions. The C icon appears in the status bars. Press the Blue key followed by the CTRL key to activate the keypad alternate ALT functions. The A icon appears in the status bar.																		
SHIFT LOCK 	Press and release the SHIFT key to activate the keypad alternate SHIFT functions. <ol style="list-style-type: none"> Press the SHIFT key once to put the keyboard into Shift mode. The  icon appears in the status bar. After you press another key, the keypad returns to the non-shift state. Press and release the SHIFT key twice to enable the Shift Lock state. The  icon appears in the status bar. Press and release the SHIFT key again to disable the Shift Lock state. The  icon clears. 																		
Period/Decimal Point 	Produces a period for alpha entries and a decimal point for numeric entries.																		
Diamond 	Provides a 3x3 matrix on the screen with nine additional symbols. With a single tap, you can select via touch input or the keyboard, 1-9 numerical keys. Double tapping the Diamond key locks the 3x3 grid, and you can select multiple keys. Pressing the Diamond key a third time closes the 3x3 matrix. You can modify the symbols in the 3x3 matrix using the StageNow utility in the KeyMappingMgr settings. <div style="border: 1px solid gray; padding: 5px; margin: 10px 0;"> <table border="1" style="border-collapse: collapse; text-align: center; width: 100%;"> <tr> <td style="padding: 2px 5px;">7</td> <td style="padding: 2px 5px;">8</td> <td style="padding: 2px 5px;">9</td> </tr> <tr> <td style="padding: 2px 5px;"> </td> <td style="padding: 2px 5px;">[</td> <td style="padding: 2px 5px;">]</td> </tr> <tr> <td style="padding: 2px 5px;">4</td> <td style="padding: 2px 5px;">5</td> <td style="padding: 2px 5px;">6</td> </tr> <tr> <td style="padding: 2px 5px;">£</td> <td style="padding: 2px 5px;">:</td> <td style="padding: 2px 5px;">€</td> </tr> <tr> <td style="padding: 2px 5px;">1</td> <td style="padding: 2px 5px;">2</td> <td style="padding: 2px 5px;">3</td> </tr> <tr> <td style="padding: 2px 5px;">~</td> <td style="padding: 2px 5px;">@</td> <td style="padding: 2px 5px;">-</td> </tr> </table> </div> This is the default symbol layout for this keyboard.	7	8	9		[]	4	5	6	£	:	€	1	2	3	~	@	-
7	8	9																	
	[]																	
4	5	6																	
£	:	€																	
1	2	3																	
~	@	-																	
Enter 	Executes a selected item or function.																		

53-Keys VT Emulator Keypad

The VT emulator keypad contains a Power button, application keys, scroll keys, and a function key. The keypad is color-coded to indicate the alternate function key (blue) values.



NOTE: Note that keypad functions can be changed by an application, so the keypad may not function exactly as described. See [Special Characters](#) on page 197 for key and button details and [Keypad Special Functions](#) on page 196 for the keypad’s various functions.

Figure 43 53-Keys VT Emulator Keypad

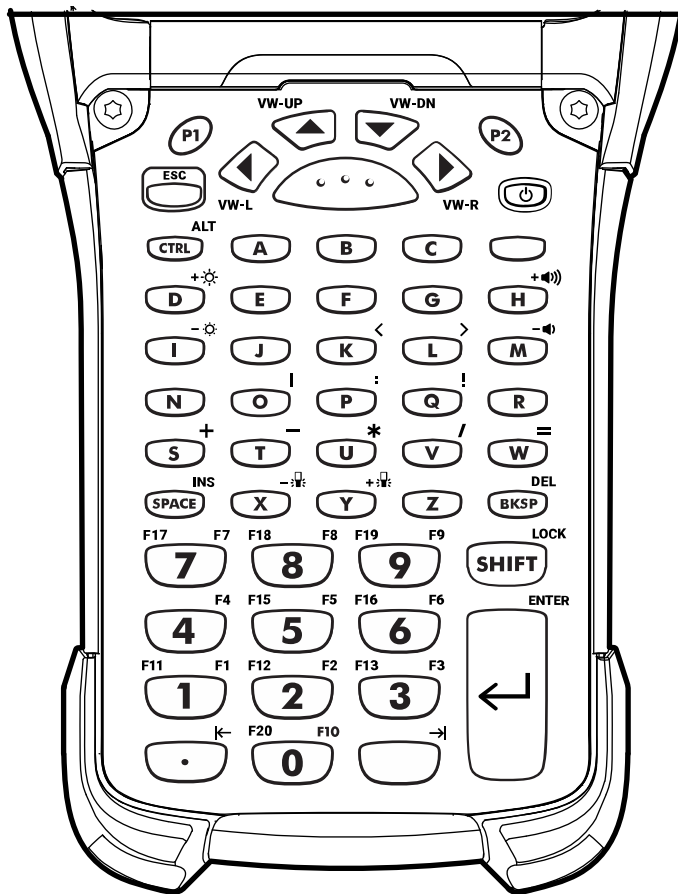

NOTE: The VT emulator configuration is only used when the device is running the VT emulation software.

Table 27 VT Emulator Descriptions

Key	Description
Power (Red) 	Turns the device on and off. Performs a warm boot and a hard reset. For more information, see Resetting the Device .

Table 27 VT Emulator Descriptions (Continued)





















Key	Description
P1/P2 	User-programmable keys: <ul style="list-style-type: none"> By default, P1 is the dedicated PTT key. By default, P2 acts like another Scan key.
Scan (Yellow) 	Activates the scanner/imager in a scan-enabled application.
Up/Down <small>VW-UP VW-DN</small> 	Moves up and down from one item to another.
Left/Right  <small>VW-RVW-L</small>	Moves left and right from one item to another.
ESC 	Exits the current operation.
Alpha 	Use the alpha keys for alphabetic characters.
SPACE/BKSP 	Space and backspace functions.
Application <small>F11 F1 F12 F2 F13 F3</small> 	The numeric keys generate keycodes 0 to 9. These keys can also be assigned to an application.
Function (Blue) 	<p>Press and release the Blue function key to activate the keypad alternate functions (shown on the keypad in Blue).</p> <ol style="list-style-type: none"> Press the Blue function key once to put the keyboard into one-shot mode. The  icon appears on the Status bar. Press the Blue function key again. The keypad is locked in function mode, and the  icon appears in the Status bar. Press and release the Blue function key a third time to return to the default keypad functions. The  icon clears. <p>Press the blue function key and SHIFT to activate CAPSLOCK mode. The  icon appears.</p>

Table 27 VT Emulator Descriptions (Continued)

Key	Description																		
CTRL ALT 	<p>Press and release the CTRL key to activate the keypad alternate CTRL functions. The C icon appears in the status bar.</p> <p>Press the Blue key followed by the CTRL key to activate the keypad alternate ALT functions. The A icon appears in the status bar.</p>																		
SHIFT LOCK 	<p>Press and release the SHIFT key to activate the keypad alternate SHIFT functions.</p> <ol style="list-style-type: none"> Press the SHIFT key once to put the keyboard into Shift mode. The  icon appears in the status bar. After you press another key, the keypad returns to the non-shift state. Press and release the SHIFT key twice to enable the Shift Lock state. The  icon appears in the status bar. Press and release the SHIFT key again to disable the Shift Lock state. The  icon clears. 																		
Period/Decimal Point 	<p>Produces a period for alpha entries and decimal point for numeric entries.</p>																		
Diamond	<p>Provides a 3x3 matrix on the screen with nine additional symbols. With a single tap, you can select via touch input or the keyboard, 1-9 numerical keys. Double tapping the Diamond key locks the 3x3 grid, and you can select multiple keys.</p> <p>Pressing the Diamond key a third time closes the 3x3 matrix. You can modify the symbols in the 3x3 matrix using the StageNow utility in the KeyMappingMgr settings.</p> <div data-bbox="634 1266 1016 1587" style="border: 1px solid gray; padding: 5px; text-align: center;"> <table style="border-collapse: collapse; width: 100%;"> <tr> <td style="border: 1px solid gray; width: 33.33%; height: 30px;">7</td> <td style="border: 1px solid gray; width: 33.33%; height: 30px;">8</td> <td style="border: 1px solid gray; width: 33.33%; height: 30px;">9</td> </tr> <tr> <td style="border: 1px solid gray; text-align: center;"> </td> <td style="border: 1px solid gray; text-align: center;">[</td> <td style="border: 1px solid gray; text-align: center;">]</td> </tr> <tr> <td style="border: 1px solid gray; height: 30px;">4</td> <td style="border: 1px solid gray; height: 30px;">5</td> <td style="border: 1px solid gray; height: 30px;">6</td> </tr> <tr> <td style="border: 1px solid gray; text-align: center;">£</td> <td style="border: 1px solid gray; text-align: center;">:</td> <td style="border: 1px solid gray; text-align: center;">€</td> </tr> <tr> <td style="border: 1px solid gray; height: 30px;">1</td> <td style="border: 1px solid gray; height: 30px;">2</td> <td style="border: 1px solid gray; height: 30px;">3</td> </tr> <tr> <td style="border: 1px solid gray; text-align: center;">~</td> <td style="border: 1px solid gray; text-align: center;">@</td> <td style="border: 1px solid gray; text-align: center;">-</td> </tr> </table> </div> <p>This is the default symbol layout for this keyboard.</p>	7	8	9		[]	4	5	6	£	:	€	1	2	3	~	@	-
7	8	9																	
	[]																	
4	5	6																	
£	:	€																	
1	2	3																	
~	@	-																	
Enter 	<p>Executes a selected item or function.</p>																		

43-Keys Shifted Alpha Keypad

The 43-key keypad contains a Power button, application keys, scroll keys and a function key. The keypad is color-coded to indicate the alternate function key (blue) values and the alternate ALPHA key (orange) values.



NOTE: Note that keypad functions can be changed by an application, so the keypad may not function exactly as described. See [Special Characters](#) on page 197 for key and button details and [Keypad Special Functions](#) on page 196 for the keypad’s various functions.

Figure 44 43-Keys Shifted Alpha Keypad

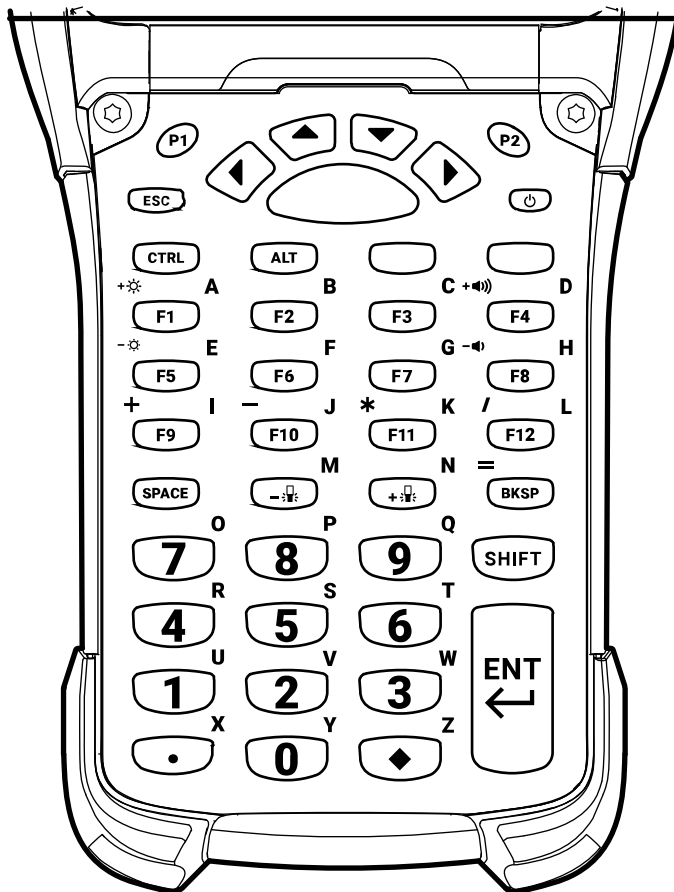

Table 28 43 Shifted Alpha Descriptions

Key	Description
Power (Red) 	Turns the device on and off. Performs a warm boot and a hard reset. For more information, see Resetting the Device .

Table 28 43 Shifted Alpha Descriptions (Continued)















Key	Description
P1/P2  	User-programmable keys: <ul style="list-style-type: none"> • By default, P1 is the dedicated PTT key. • By default, P2 acts like another Scan key.
Scan (Yellow) 	Activates the scanner/imager in a scan enabled application.
Up and Down  	Moves up and down from one item to another.
Left and Right  	Moves left and right from one item to another.
ESC 	Exits the current operation.
CTRL 	Press and release the CTRL key to activate the keypad alternate CTRL functions. The C icon appears in the status bar.
ALT 	Press the Blue function key followed by the CTRL key to activate the keypad alternate ALT functions. The A icon appears in the status bar.
SPACE/BKSP  	Space and backspace functions.
Application   	The numeric keys generate keycodes 0 to 9.

Table 28 43 Shifted Alpha Descriptions (Continued)

















Key	Description
<p>Function (Blue)</p> 	<p>Press and release the Blue function key to activate the keypad alternate functions (shown on the keypad in Blue).</p> <ol style="list-style-type: none"> 1. Press the Blue function key once to put the keyboard into one-shot mode. The  icon appears on the Status bar. 2. Press the Blue function key again. The keypad is locked in function mode, and the  icon appears in the Status bar. 3. Press and release the Blue function key a third time to return to the default keypad functions. The  icon clears. <p>Press the blue function key and SHIFT to activate CAPSLOCK mode. The  icon appears.</p>
<p>Function (Orange)</p> 	<p>Press and release the Orange function key to activate the keypad alternate functions (shown on the keypad in Orange).</p> <ol style="list-style-type: none"> 1. Press the Orange function key once to put the keyboard into one-shot mode. The  icon appears on the Status bar. 2. Press the Orange function key again. The keypad is locked in function mode, and the  icon appears in the Status bar. 3. Press and release the Orange function key a third time to return to the default keypad functions. The  icon clears.
<p>Shift</p> 	<p>Press and release the SHIFT key to activate the keypad alternate SHIFT functions.</p> <ol style="list-style-type: none"> 1. Press the SHIFT key once to put the keyboard into Shift mode. The  icon appears in the status bar. After you press another key, the keypad returns to the non-shift state. 2. Press and release the SHIFT key twice to enable the Shift Lock state. The  icon appears in the status bar. 3. Press and release the SHIFT key again to disable the Shift Lock state. The  icon clears.
<p>Period/Decimal Point</p> 	<p>Produces a period for alpha entries and a decimal point for numeric entries.</p>

Table 28 43 Shifted Alpha Descriptions (Continued)

Key	Description
<p>Diamond</p> 	<p>Provides a 3x3 matrix on the screen with nine additional symbols. With a single tap, you can select via touch input or the keyboard, 1-9 numerical keys. Double tapping the Diamond key locks the 3x3 grid, and you can select multiple keys.</p> <p>Pressing the Diamond key a third time closes the 3x3 matrix. You can modify the symbols in the 3x3 matrix using the StageNow utility in the KeyMappingMgr settings.</p>  <p>This is the default symbol layout for this keyboard.</p>
<p>Enter</p> 	<p>Executes a selected item or function.</p>

34-Keys Numeric Keypad

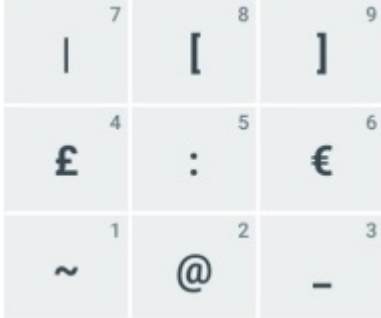
The 34-key keypad contains a Power button, application keys, scroll keys, and a function key. The keypad is color-coded to indicate the alternate function key (blue) values and the alternate Shift key values.



NOTE: Note that keypad functions can be changed by an application, so the keypad may not function exactly as described. See [Special Characters](#) on page 197 for key and button details and [Keypad Special Functions](#) on page 196 for the keypad's various functions.

Figure 45 34-Keys Numeric Keypad

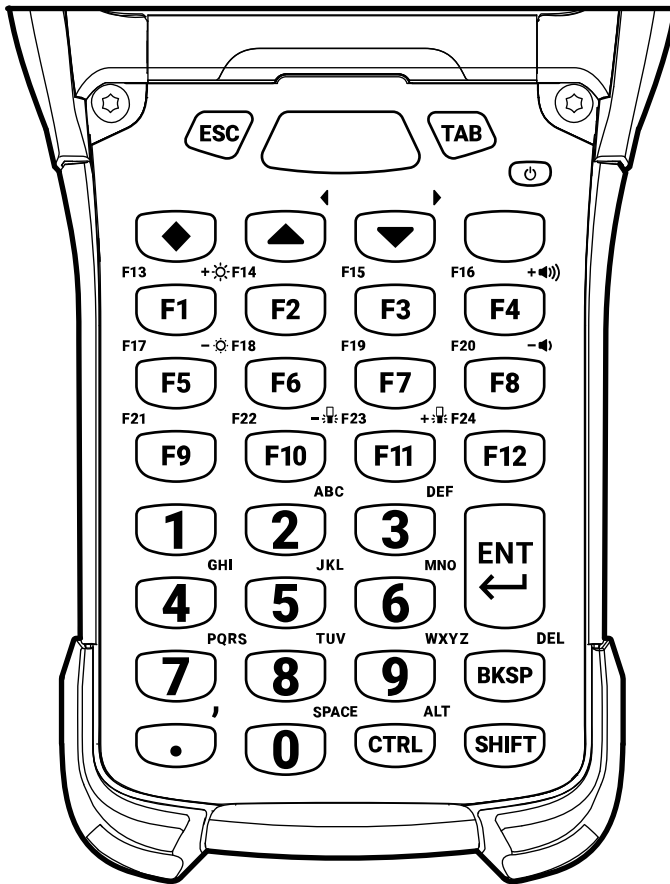

Table 29 34-Keys Numeric Keypad

Key	Description
Power (red) 	Turns the device on and off. Performs a warm boot and a hard reset. For more information, see Resetting the Device .

Table 29 34-Keys Numeric Keypad (Continued)























Key	Description
<p>Diamond</p> 	<p>Provides a 3x3 matrix on the screen with nine additional symbols. With a single tap, you can select via touch input or the keyboard, 1-9 numerical keys. Double tapping the Diamond key locks the 3x3 grid, and you can select multiple keys.</p> <p>Pressing the Diamond key a third time closes the 3x3 matrix. You can modify the symbols in the 3x3 matrix using the StageNow utility in the KeyMappingMgr settings.</p>  <p>This is the default symbol layout for this keyboard.</p>
<p>ESC</p> 	<p>Exits the current operation.</p>
<p>TAB</p> 	<p>Tab function.</p>
<p>Scan (yellow)</p> 	<p>Activates the scanner/imager in a scan-enabled application.</p>
<p>Up and Down</p>  	<p>Moves up and down from one item to another.</p>
<p>BKSP</p> 	<p>Space and backspace functions.</p>
<p>Application</p> 	<p>The numeric keys generate keycodes 0 to 9.</p>

Table 29 34-Keys Numeric Keypad (Continued)

Key	Description
<p>Function (blue)</p> 	<p>Press and release the Blue function key to activate the keypad alternate functions (shown on the keypad in Blue).</p> <ol style="list-style-type: none"> Press the Blue function key once to put the keyboard into one-shot mode. The  icon appears on the Status bar. Press the Blue function key again. The keypad is locked in function mode, and the  icon appears in the Status bar. Press and release the Blue function key a third time to return to the default keypad functions. The  icon clears. <p>Press the blue function key and SHIFT to activate CAPSLOCK mode. The  icon appears.</p>
<p>CTRL</p> 	<p>Press and release the CTRL key to activate the keypad alternate CTRL functions. The  icon appears in the status bars.</p>
<p>Shift</p> 	<p>Press and release the SHIFT key to activate the keypad alternate SHIFT functions.</p> <ol style="list-style-type: none"> Press the SHIFT key once to put the keyboard into Shift mode. The  icon appears in the status bar. After you press another key, the keypad returns to the non-shift state. Press and release the SHIFT key twice to enable the Shift Lock state. The  icon appears in the status bar. Press and release the SHIFT key again to disable the Shift Lock state. The  icon clears.
<p>Period/Decimal Point</p> 	<p>Produces a period for alpha entries and a decimal point for numeric entries.</p>
<p>ENT</p> 	<p>Executes a selected item or function.</p>

29-Keys Shifted Alpha Keypad

The 29-key keypad contains a Power button, application keys, scroll keys and a function key. The keypad is color-coded to indicate the alternate function key (blue) values and the alternate ALPHA key (orange) values.



NOTE: Note that keypad functions can be changed by an application, so the keypad may not function exactly as described. See [Special Characters](#) on page 197 for key and button details and [Keypad Special Functions](#) on page 196 for the keypad’s various functions.

Figure 46 29-Keys Shifted Alpha Keypad

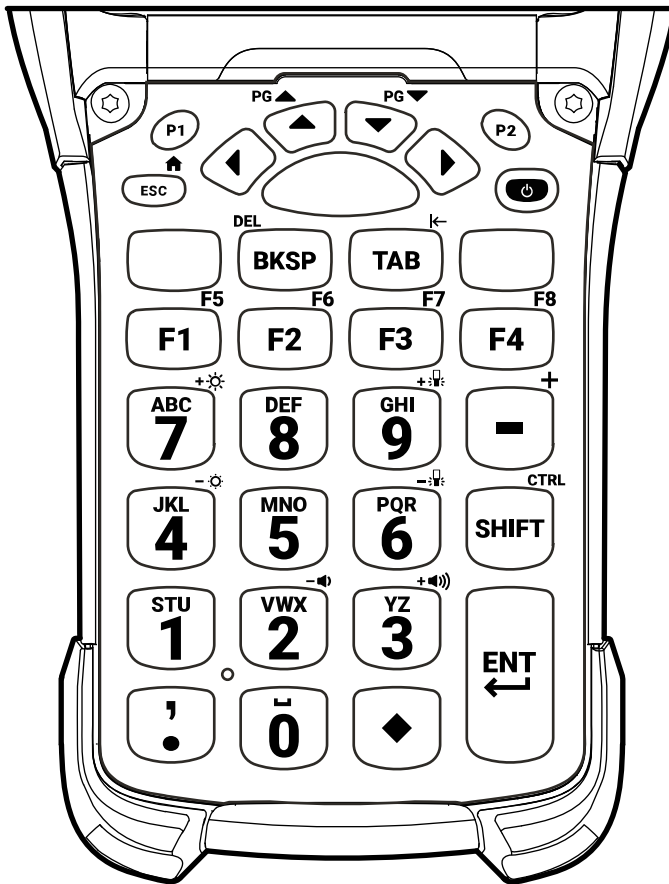

Table 30 29-Keys Descriptions

Key	Description
Power (red) 	Turns the device on and off. Performs a warm boot and a hard reset. For more information, see Resetting the Device .

Table 30 29-Keys Descriptions (Continued)















Key	Description
P1/P2  	User-programmable keys: <ul style="list-style-type: none"> • By default, P1 is the dedicated PTT key. • By default, P2 acts like another Scan key.
Scan (Yellow) 	Activates the scanner/imager in a scan-enabled application.
Up and Down  	Moves up and down from one item to another.
Left and Right  	Moves left and right from one item to another.
ESC 	Exits the current operation.
Shift <small>CTRL</small> 	Press and release the SHIFT key to activate the keypad alternate SHIFT functions. <ol style="list-style-type: none"> 1. Press the SHIFT key once to put the keyboard into Shift mode. The  icon appears in the status bar. After you press another key, the keypad returns to the non-shift state. 2. Press and release the SHIFT key twice to enable the Shift Lock state. The  icon appears in the status bar. 3. Press and release the SHIFT key again to disable the Shift Lock state. The  icon clears.
BKSP 	Backspace function.
TAB 	Tab function.

Table 30 29-Keys Descriptions (Continued)











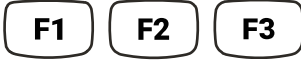



Key	Description
Numeric 	The numeric keys generate keycodes 0 to 9.
Application 	The application keys.
Function (Blue) 	<p>Press and release the Blue function key to activate the keypad alternate functions (shown on the keypad in Blue).</p> <ol style="list-style-type: none"> Press the Blue function key once to put the keyboard into one-shot mode. The  icon appears on the Status bar. Press the Blue function key again. The keypad is locked in function mode, and the  icon appears in the Status bar. Press and release the Blue function key a third time to return to the default keypad functions. The  icon clears. <p>Press the blue function key and SHIFT to activate CAPSLOCK mode. The  icon appears.</p>
Function (Orange) 	<p>Press and release the Orange function key to activate the keypad alternate functions (shown on the keypad in Orange).</p> <ol style="list-style-type: none"> Press the Orange function key once to put the keyboard into one-shot mode. The  icon appears on the Status bar. Press the Orange function key again. The keypad is locked in function mode, and the  icon appears in the Status bar. Press and release the Orange function key a third time to return to the default keypad functions. The  icon clears.
Period/Decimal Point 	Produces a period for alpha entries and a decimal point for numeric entries.

Table 30 29-Keys Descriptions (Continued)

Key	Description
<p>Diamond</p> 	<p>Provides a 3x3 matrix on the screen with nine additional symbols. With a single tap, you can select via touch input or the keyboard, 1-9 numerical keys. Double tapping the Diamond key locks the 3x3 grid, and you can select multiple keys. Pressing the Diamond key a third time closes the 3x3 matrix. You can modify the symbols in the 3x3 matrix using the StageNow utility in the KeyMappingMgr settings.</p>  <p>This is the default symbol layout for this keyboard.</p>
<p>Enter</p> 	<p>Executes a selected item or function.</p>

Keypad Special Functions

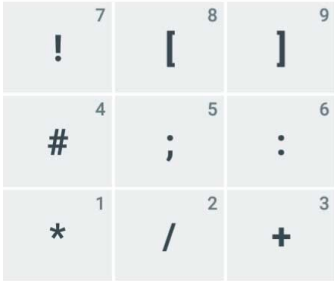
The keypad special functions are color coded on the keypads. For example, on the 53-key keypad, the display backlight icon is blue, indicating that the blue function key must be selected first to access the display backlight.

Table 31 Keypad Special Functions



Icon	Special Function	58 Key (Omni XT15f)	53 Key (Standard, 5250, 3270, VT)	43 Key	34 Key (Omni XT15f)	29 Key
	Decreases the keyboard backlight intensity.	Blue key+Y	Blue key + X	Keylight+Down	Blue key+F10	Blue key+7
	Increases the keypad backlight intensity.	Blue key+Z	Blue key + Y	Keylight+Up	Blue key+F11	Blue key+9
	Increases display backlight intensity.	Blue key+N	Blue key + D	Blue key+F1	Blue key+F1	Blue key+7

Table 31 Keypad Special Functions (Continued)

Icon	Special Function	58 Key (Omni XT15f)	53 Key (Standard, 5250, 3270, VT)	43 Key	34 Key (Omni XT15f)	29 Key
	Decreases display backlight intensity.	Blue key+M	Blue key + I	Blue key+F5	Blue key+F5	Blue key+4
	Increases overall system volume.	Blue key+R	Blue key + H	Blue key+F4	Blue key+F4	Blue key+3
	Decreases volume.	Blue key+Q	Blue key + M	Blue key+F8	Blue key+F8	Blue key+2
ALT	Enables Alt keypad functions.*	Blue key +CTRL	Blue key + CTRL	ALT	Blue key+ CTRL	
	Caps Lock	Blue key +SHIFT	BLUE + SHIFT	Blue key +SHIFT	Blue key SHIFT	
	Sends TAB character (forward tab).	TAB	Blue key + Space	Blue key +SPACE	TAB	TAB

* Only applicable if the Large Key Indicator is enabled. To enable the large key indicator, go to **Settings > System > Languages & input > Keypad Indicators**.

Special Characters

The keypads can be selected as necessary to support specialized applications. The keypads contain a Power button, application keys, scroll keys and function keys. The keypad is color-coded to indicate the alternate function key (blue/orange) values. The following table details special character generation. Characters can also be generated using the keyboard input panel.



NOTE: Shift-1 through Shift-0 only applies to the Standard 53-key keyboard. On the 5250, 3270, and VT 53-key keyboards the Shift + <num> combinations generate F11-F20 keys.

Table 32 Special Characters

Special Character	58 Key (Omni XT15f)	53 Key (Standard, 5250, 3270, VT)	43 Key	34 Key (Omni XT15f)	29 Key
[(open square bracket)	Diamond+2	Blue Key+E	Diamond+8	Diamond+2	Diamond +8
] (close square bracket)	Diamond+3	Blue Key+F	Diamond+9	Diamond+3	Diamond +9
/ (forward slash)	Not Applicable	Blue Key+V	Blue Key+F12	Not Applicable	Blue Key +8
\ (backslash)	Not Applicable	Blue Key+G	Not Applicable	Not Applicable	Not Applicable

Keypads

Table 32 Special Characters (Continued)

Special Character	58 Key (Omni XT15f)	53 Key (Standard, 5250, 3270, VT)	43 Key	34 Key (Omni XT15f)	29 Key
= (equal sign)	Not Applicable	Blue Key+W	Blue Key+Bksp	Not Applicable	Blue Key +5
;(semi-colon)	Not Applicable	Blue Key+R	Not Applicable	Not Applicable	Diamond +5
` (apostrophe)	Not Applicable	Blue Key+J	Not Applicable	Not Applicable	Not Applicable
, (comma)	Shift+. (Dot)	Blue Key+A	Not Applicable	Blue Key+. (Dot)	Not Applicable
. (period)	Dot	Blue Key+B	Not Applicable	Dot	Not Applicable
! (exclamation sign)	Shift+1	Shift+1	Shift+1	Shift+1	Shift+1
@ (at sign)	Shift+2	Shift+2	Shift+2	Shift+2	Shift+2
# (pound sign)	Shift+3	Shift+3	Shift+3	Shift+3	Shift+3
\$ (dollar sign)	Shift+4	Shift+4	Shift+4	Shift+4	Shift+4
% (percent sign)	Shift+5	Shift+5	Shift+5	Shift+5	Shift+5
^ (carat)	Shift+6	Shift+6	Shift+6	Shift+6	Shift+6
& (ampersand)	Shift+7	Shift+7	Shift+7	Shift+7	Shift+7
* (asterisk)	Shift+8	Blue Key+UShift+8	Blue Key+F11, Shift+8	Shift+8	Shift+8
((open parenthesis)	Shift+9	Shift+9	Shift+9	Shift+9	Shift+9
) (close parenthesis)	Shift+0	Shift+0	Shift+0	Shift+0	Shift+0
' (single quote)	Not Applicable	Blue Key+C	Not Applicable	Not Applicable	Not Applicable
" (double quote)	Not Applicable	Shift+Blue Key+C	Not Applicable	Not Applicable	Not Applicable
+ (plus sign)	Not Applicable	Blue Key+S	Blue Key+F9	Not Applicable	Orange Key+ - (Minus)
- (dash)	Not Applicable	Blue Key+N, Blue Key+T	Blue Key+F10	Not Applicable	Minus key
: (colon)	Diamond+5	Shift+Blue Key+R	Diamond+5	Diamond+5	Diamond +6
< (less than sign)	Shift+Blue Key+. (Dot)	Shift+Blue Key+A	Not Applicable	Shift + Blue Key+. (Dot)	Shift+ Orange Key+ . (Dot)
> (greater than sign)	Shift+. (Dot)	Shift+Blue Key+B	Shift+. (Dot)	Shift+. (Dot)	Shift+. (Dot)

Table 32 Special Characters (Continued)

Special Character	58 Key (Omni XT15f)	53 Key (Standard, 5250, 3270, VT)	43 Key	34 Key (Omni XT15f)	29 Key
? (question mark)	Not Applicable	Shift+Blue Key+V	Shift+Blue Key +F12	Not Applicable	Shift +Blue Key +8
_ (underscore)	Diamond+9	Shift+Blue Key+N	Diamond+3	Diamond+9	Shift + - (Minus)
{ (open curly bracket)	Not Applicable	Shift+Blue Key+E	Not Applicable	Not Applicable	Not Applicable
} (close curly bracket)	Not Applicable	Shift+Blue Key+F	Not Applicable	Not Applicable	Not Applicable
~ (tilde)	Diamond+7	Shift+Blue Key+J	Diamond+1	Diamond+7	Not Applicable
(pipe)	Diamond+1	Shift+Blue Key+G	Diamond+7	Diamond+1	Not Applicable

Maintenance and Troubleshooting

This section explains how to maintain and troubleshoot the device.

Maintaining the Device

Follow these guidelines to maintain the device properly.

For trouble-free service, observe the following tips when using the device:

- To avoid scratching the screen, use a Zebra approved capacitive compatible stylus intended for use with a touch-sensitive screen. Never use an actual pen or pencil or other sharp object on the surface of the device screen.
- The touch-sensitive screen of the device is glass. Do not drop the device or subject it to strong impact.
- Protect the device from temperature extremes. Do not leave it on the dashboard of a car on a hot day, and keep it away from heat sources.
- Do not store the device in any location that is dusty, damp, or wet.
- Use a soft lens cloth to clean the device. If the surface of the device screen becomes soiled, clean it with a soft cloth moistened with an approved cleanser.
- Periodically replace the rechargeable battery to ensure maximum battery life and product performance. Battery life depends on individual usage patterns.
- A screen protector is applied to the device. Zebra recommends using a screen protector to minimize wear and tear. Screen protectors enhance the usability and durability of touch screen displays. Benefits include:
 - Protection from scratches and gouges
 - Durable writing and touch surface with tactile feel
 - Abrasion and chemical resistance
 - Glare reduction
 - Keeping the device's screen looking new
 - Quick and easy installation.

Battery Safety Guidelines

To use the device safely, you must follow the battery guidelines. Improper battery use may result in a fire, explosion, or other hazard.

- The area in which the units are charged should be clear of debris and combustible materials or chemicals. Particular care should be taken when the device is charged in a non-commercial environment.
- Follow the battery usage, storage, and charging guidelines found in this guide.
- To charge the mobile device battery, the ambient battery and charger temperatures must be between 0°C and +40°C (+32°F and +104°F).
- Do not use incompatible batteries and chargers, including non-Zebra batteries and chargers. Use of an incompatible battery or charger may present a risk of fire, explosion, leakage, or other hazard. If you have any questions about the compatibility of a battery or a charger, contact the Global Customer Support Center.
- For devices that utilize a USB port as a charging source, the device shall only be connected to products that bear the USB-IF logo or have completed the USB-IF compliance program.
- Do not disassemble, open, crush, bend, deform, puncture, or shred the battery.
- Severe impact from dropping any battery-operated device on a hard surface could cause the battery to overheat.
- Do not short-circuit a battery or allow metallic or conductive objects to contact the battery terminals.
- Do not modify or remanufacture, attempt to insert foreign objects into the battery, immerse or expose to water or other liquids, or expose to fire, explosion, or other hazard.
- Do not leave or store the equipment in or near areas that might get very hot, such as in a parked vehicle or near a radiator or other heat source. Do not place a battery into a microwave oven or dryer.
- Battery usage by children should be supervised.
- Please follow local regulations to properly dispose of used rechargeable batteries.
- Do not dispose of batteries in a fire.
- In the event of a battery leak, do not allow the liquid to come in contact with the skin or eyes. If contact has been made, wash the affected area with water for 15 minutes, and seek medical advice.
- If you suspect damage to your equipment or battery, contact Customer Support to arrange for inspection.

Cleaning Instructions



CAUTION: Always wear eye protection. Read the warning label on alcohol product before using. If you have to use any other solution for medical reasons please contact the Global Customer Support Center for more information.



WARNING: Avoid exposing this product to contact with hot oil or other flammable liquids. If such exposure occurs, unplug the device and clean the product immediately in accordance with these guidelines.

Approved Cleanser Active Ingredients

100% of the active ingredients in any cleaner must consist of one or some combination of the following: isopropyl alcohol, bleach/sodium hypochlorite¹ (see important note below), hydrogen peroxide, ammonium chloride, or mild dish soap.



IMPORTANT: Use pre-moistened wipes and do not allow liquid cleaner to pool.

Due to the powerful oxidizing nature of sodium hypochlorite, the metal surfaces on the device are prone to oxidation (corrosion) when exposed to this chemical in the liquid form (including wipes). In the event that these type of disinfectants come in contact with metal on the device, prompt removal with an alcohol-dampened cloth or cotton swab after the cleaning step is critical.

Approved cleaners include:

- Purell Ethanol Wipes
- 409 Glass Cleaner
- Windex Blue

Harmful Ingredients

The following chemicals are known to damage the plastics on the device and should not come in contact with the device: acetone; ketones; ethers; aromatic and chlorinated hydrocarbons; aqueous or alcoholic alkaline solutions; ethanolamine; toluene; trichloroethylene; benzene; carbolic acid and TB-lysoform.

Many vinyl gloves contain phthalate additives, which are often not recommended for medical use and are known to be harmful to the housing of the device.

Device Cleaning Instructions

Do not apply liquid directly to the device. Dampen a soft cloth or use pre-moistened wipes. Do not wrap the device in the cloth or wipe, instead gently wipe the unit. Be careful not to let liquid pool around the display window or other places. Before use, allow the unit to air dry.



NOTE: For thorough cleaning, it is recommended to first remove all accessory attachments, such as hand straps or cradle cups from the mobile device and to clean them separately.

Special Cleaning Notes

Do not handle the device while wearing vinyl gloves containing phthalates. Remove vinyl gloves and wash hands to eliminate any residue left from the gloves.

If products containing any of the harmful ingredients listed above are used prior to handling the device, such as a hand sanitizer that contains ethanolamine, hands must be completely dry before handling the device to prevent damage to the device.



IMPORTANT: If the battery connectors are exposed to cleaning agents, thoroughly wipe off as much of the chemical as possible and clean with an alcohol wipe. It is also recommended to

¹ When using sodium hypochlorite (bleach) based products, always follow the manufacturer's recommended instructions: use gloves during application and remove the residue afterwards with a damp alcohol cloth or a cotton swab to avoid prolonged skin contact while handling the device.

install the battery in the terminal prior to cleaning and disinfecting the device to help minimize buildup on the connectors. When using cleaning/disinfectant agents on the device, it is important to follow the directions prescribed by the cleaning/disinfectant agent manufacturer.

Cleaning Materials Required

- Alcohol wipes
- Lens tissue
- Cotton-tipped applicators
- Isopropyl alcohol
- Can of compressed air with a tube.

Cleaning Frequency

The cleaning frequency is at the customer's discretion due to the varied environments in which the mobile devices are used and may be cleaned as frequently as required. When dirt is visible, it is recommended to clean the mobile device to avoid the build-up of particles, which makes the device more difficult to clean later on.

For consistency and optimum image capture, it is recommended to clean the camera window periodically especially when used in environments prone to dirt or dust.

Cleaning the Device

This section describes how to clean the housing, display, and camera for the device.

Housing

Thoroughly wipe the housing, including all buttons and triggers, using an approved alcohol wipe.

Display

The display can be wiped down with an approved alcohol wipe, but care should be taken not to allow any pooling of liquid around the edges of the display. Immediately dry the display with a soft, non-abrasive cloth to prevent streaking.

Camera and Exit Window

Wipe the camera and exit window periodically with lens tissue or other material suitable for cleaning optical material such as eyeglasses.

Cleaning Battery Connectors

1. Remove the main battery from the mobile computer.
2. Dip the cotton portion of the cotton-tipped applicator in isopropyl alcohol.

3. To remove any grease or dirt, rub the cotton portion of the cotton-tipped applicator back and forth across the connectors on the battery and terminal sides. Do not leave any cotton residue on the connectors.
4. Repeat at least three times.
5. Use a dry cotton-tipped applicator and repeat steps 3 and 4. Do not leave any cotton residue on the connectors.
6. Inspect the area for any grease or dirt and repeat the cleaning process if necessary.



CAUTION: After cleaning the battery connectors with bleach-based chemicals, follow the Battery Connector Cleaning instructions to remove bleach from the connectors.

Cleaning Cradle Connectors

1. Remove the DC power cable from the cradle.
2. Dip the cotton portion of the cotton-tipped applicator in isopropyl alcohol.
3. Rub the cotton portion of the cotton-tipped applicator along the pins of the connector. Slowly move the applicator back and forth from one side of the connector to the other. Do not leave any cotton residue on the connector.
4. All sides of the connector should also be rubbed with the cotton-tipped applicator.
5. Remove any lint left by the cotton-tipped applicator.
6. If grease and other dirt can be found on other areas of the cradle, use a lint-free cloth and alcohol to remove.
7. Allow at least 10 to 30 minutes (depending on ambient temperature and humidity) for the alcohol to air dry before applying power to cradle.

If the temperature is low and humidity is high, longer drying time is required. Warm temperature and low humidity requires less drying time.



CAUTION: After cleaning the cradle connectors with bleach-based chemicals, follow the Cleaning Cradle Connectors instructions to remove bleach from the connectors.

Troubleshooting

This section provides information for resetting and troubleshooting the device and accessories.

Resetting the Device

This section describes options to reset the device.

There are four reset functions:

- Soft reset
- Hard reset
- Enterprise reset
- Factory reset

See Also

- [Performing a Soft Reset](#)
- [Performing a Hard Reset](#)
- [Android Enterprise Reset](#)
- [Android Factory Reset](#)

Performing a Soft Reset

Perform a soft reset if applications stop responding.

1. Press and hold **Power** until the menu appears.
2. Touch **Restart**.

The device reboots.

Performing a Hard Reset

Perform a hard reset if the device stops responding.



CAUTION: Performing a hard reset with a USB drive installed in the device may cause damage or data corruption to the USB drive.

1. Press and hold the trigger, **Power**, and **Scan** for at least 6 seconds.
2. Release the buttons when the Zebra logo appears.

The device reboots.

Troubleshooting the Device

The following table includes basic troubleshooting information.

Table 33 Troubleshooting the Device

Problem	Cause	Solution
When pressing the power button the device does not turn on.	The battery is not charged.	Charge or replace the battery in the device.
	The battery is not installed properly.	Install the battery properly.
	System crash.	Perform a reset.
When pressing the power button, the device does not turn on, but the LED bar blinks.	Battery charge is at a level where data is maintained, but the battery should be recharged.	Charge or replace the battery in the device.
The battery did not charge.	Battery failed.	Replace battery. If the device still does not operate, perform a reset.
	The device was removed from the cradle while the battery was charging.	Insert the device in the cradle. The 7,000 mAh battery fully charges in less than 5 hours at room temperature.

Table 33 Troubleshooting the Device (Continued)

Problem	Cause	Solution
	Extreme battery temperature.	The battery does not charge if the ambient temperature is below 0°C (32°F) or above 40°C (104°F).
Cannot see characters on display.	The device is not powered on.	Press Power .
During data communication with a host computer, no data transmitted, or transmitted data was incomplete.	The device was removed from the cradle or disconnected from the host computer during communication.	Replace the device in the cradle, or reattach the communication cable and re-transmit.
	Incorrect cable configuration.	See the system administrator.
	Communication software was incorrectly installed or configured.	Perform setup.
During data communication over Wi-Fi, no data was transmitted, or transmitted data was incomplete.	The Wi-Fi radio is not on.	Turn on the Wi-Fi radio.
	You moved out of range of an access point.	Move closer to an access point.
During data communication over Bluetooth, no data transmitted, or transmitted data was incomplete.	The Bluetooth radio is not on.	Turn on the Bluetooth radio.
	You moved out of range of another Bluetooth device.	Move within 10 meters (32.8 feet) of the other device.
No sound.	The volume setting is low or turned off.	Adjust the volume.
The device shuts off.	The device is inactive.	The display turns off after a period of inactivity. Set this period to 15 seconds, 30 seconds, 1, 2, 5, 10, or 30 minutes.
	The battery is depleted.	Replace the battery.
Tapping the window buttons or icons does not activate the corresponding feature.	The device is not responding.	Reset the device.
A message appears stating that the device's memory is full.	Too many files are stored on the device.	Delete unused memos and records. If necessary, save these records on the host computer (or use an SD card for additional memory).
	Too many applications are installed on the device.	Remove user-installed applications on the device to recover memory. Select > Storage > FREE UP SPACE > REVIEW RECENT ITEMS . Select the unused program(s) and tap FREE UP .
The device does not decode with reading barcode.	A scanning application is not loaded.	Load a scanning application on the device or enable DataWedge. See the system administrator.
	Unreadable barcode.	Ensure the symbol is not defaced.

Table 33 Troubleshooting the Device (Continued)

Problem	Cause	Solution
	The distance between the exit window and the barcode is incorrect.	Place the device within the proper scanning range.
	The device is not programmed for the barcode.	Program the device to accept the type of bar code being scanned. Refer to the EMDK or DataWedge application.
	The device is not programmed to generate a beep.	If the device does not beep on a good decode, set the application to generate a beep on good decode.
	The battery is low.	If the scanner stops emitting a laser beam upon a trigger press, check the battery level. When the battery is low, the scanner shuts off before the device's low-battery condition notification. Note: If the scanner is still not reading symbols, contact the distributor or the Global Customer Support Center.
The device cannot find any Bluetooth devices nearby.	Too far from other Bluetooth devices.	Move closer to the other Bluetooth device(s), within a range of 10 meters (32.8 feet).
	The Bluetooth device(s) nearby are not turned on.	Turn on the Bluetooth device(s) to find.
	The Bluetooth device(s) are not in discoverable mode.	Set the Bluetooth device(s) to discoverable mode. If needed, refer to the device's user documentation for help.
Cannot unlock the device.	The user entered an incorrect password.	If you enter an incorrect password eight times, you are requested to enter a code before trying again. If you forgot the password, contact your system administrator.
Battery pack communication error.	The battery is not inserted properly.	Remove and reinsert the battery into the device.
	The battery is properly inserted; however, when the terminal is in an active vibration environment or has fallen from a high vantage point (more than 2.4 m/8 ft), it might interrupt battery communication.	Remove and reinsert the battery into the device.
	The battery communication pin is damaged.	Remove the battery and insert a new battery into the device.

1-Slot USB Charging Cradle Troubleshooting

The table below provides troubleshooting options for the cradle.

Table 34 Troubleshooting the 1-Slot USB Charging Cradle

Symptom	Possible Cause	Action
LEDs do not light when the device or spare battery is inserted.	The cradle is not receiving power.	Ensure the power cable is connected securely to both the cradle and to AC power.
	The device is not seated firmly in the cradle.	Remove and reinsert the device into the cradle, ensuring it is firmly seated.
	The spare battery is not seated firmly in the cradle.	Remove and reinsert the spare battery into the charging slot, ensuring it is firmly seated.
The device battery is not charging.	The device was removed from the cradle, or the cradle was unplugged from AC power too soon.	Ensure that the cradle is receiving power. Ensure that the device is seated correctly. Confirm main battery is charging. The battery charges from fully depleted to 90% in approximately 4 hours, and from fully depleted to 100% in approximately 5 hours.
	The battery is faulty.	Verify that other batteries charge properly. If so, replace the faulty battery.
	The device is not fully seated in the cradle.	Remove and re-insert the device into the cradle, ensuring it is firmly seated.
	Extreme battery temperature.	The battery does not charge if the ambient temperature is below 5°C (40°F) or above 40°C (104°F).
The spare battery is not charging.	The battery is not fully seated in the charging slot.	Remove and reinsert the spare battery in the cradle, ensuring it is firmly seated. The battery charges from fully depleted to 90% in approximately 4 hours, and from fully depleted to 100% in approximately 5 hours.
	The battery was inserted incorrectly.	Reinsert the battery so the charging contacts on the battery align with the contacts on the cradle.
	The battery is faulty.	Verify that other batteries charge properly. If so, replace the faulty battery.

4-Slot Charge Only Cradle Troubleshooting

The table below provides troubleshooting options for the cradle.

Table 35 Troubleshooting the 4-Slot Charge Only Cradle

Problem	Cause	Solution
The battery is not charging.	The device was removed from the cradle too soon.	Replace the device in the cradle. The battery charges from fully depleted to 90% in approximately 4 hours, and from fully depleted to 100% in approximately 5 hours.
	The battery is faulty.	Verify that other batteries charge properly. If so, replace the faulty battery.

Table 35 Troubleshooting the 4-Slot Charge Only Cradle (Continued)

Problem	Cause	Solution
	The device is not inserted correctly in the cradle.	Remove the device and reinsert it correctly. Verify charging is active. Touch  > System > About phone > Status to view battery status.
	The ambient temperature of the cradle is too warm.	Move the cradle to an area where the ambient temperature is between 5°C (40°F) or above 40°C (104°F).
Spare Battery not charging.	The charger is not receiving power.	Ensure the power cable is connected securely to both the charger and to AC power.
	The spare battery is not correctly seated.	Remove and re-insert the battery into the battery adapter, ensuring it is correctly seated.
	The battery adapter is not seated properly.	Remove and re-insert the battery adapter into the charger, ensuring it is correctly seated.
	The battery was removed from the charger or the charger was unplugged from AC power too soon.	Ensure that the charger is receiving power. Ensure the spare battery is seated correctly. The battery charges from fully depleted to 90% in approximately 4 hours, and from fully depleted to 100% in approximately 5 hours.
	The battery is faulty.	Verify that other batteries charge properly. If so, replace the faulty battery.

4-Slot Ethernet Cradle Troubleshooting

The table below provides troubleshooting options for the cradle.

Table 36 Troubleshooting the 4-Slot Ethernet Cradle

Problem	Cause	Solution
During communication, no data transmits, or transmitted data was incomplete.	The device was removed from the cradle during communications.	Replace the device in the cradle and retransmit.
	Incorrect cable configuration.	Ensure that the correct cable configuration.
	The device has no active connection.	An icon is visible in the status bar if a connection is currently active.

Table 36 Troubleshooting the 4-Slot Ethernet Cradle (Continued)

Problem	Cause	Solution
The battery is not charging.	The device was removed from the cradle too soon.	Replace the device in the cradle. The battery charges from fully depleted to 90% in approximately 4 hours, and from fully depleted to 100% in approximately 5 hours.
	The battery is faulty.	Verify that other batteries charge properly. If so, replace the faulty battery.
	The device is not inserted correctly in the cradle.	Remove the device and reinsert it correctly. Verify charging is active. Touch  > System > About phone > Status to view battery status.
	The ambient temperature of the cradle is too warm.	Move the cradle to an area where the ambient temperature is between 5°C (+40°F) and +40°C (+104°F).

4-Slot Spare Battery Charger Troubleshooting

The table below provides troubleshooting options for the charger.

Table 37 Troubleshooting the 4-Slot Battery Charger

Problem	Cause	Solution
The spare Battery Charging LED does not light when the spare battery is inserted.	The spare battery is not correctly seated.	Remove and reinsert the spare battery into the charging slot, ensuring it is correctly seated.
The spare Battery is not charging.	The charger is not receiving power.	Ensure the power cable is connected securely to both the charger and to AC power.
	The spare battery is not correctly seated.	Remove and re-insert the battery into the battery adapter, ensuring it is correctly seated.
	The battery adapter is not seated properly.	Remove and re-insert the battery adapter into the charger, ensuring it is correctly seated.
	The battery was removed from the charger or the charger was unplugged from AC power too soon.	Ensure that the charger is receiving power. Ensure the spare battery is seated correctly. The battery charges from fully depleted to 90% in approximately 4 hours, and from fully depleted to 100% in approximately 5 hours.
	The battery is faulty.	Verify that other batteries charge properly. If so, replace the faulty battery.

16-Slot Spare Battery Charger Troubleshooting

The table below provides troubleshooting options for the charger.

Table 38 Troubleshooting the 16-Slot Battery Charger

Problem	Cause	Solution
The Spare Battery Charging LED does not light when spare battery is inserted.	The spare battery is not correctly seated.	Remove and reinsert the spare battery into the charging slot, ensuring that it is correctly seated.
Spare Battery not charging.	The charger is not receiving power.	Ensure that the power cable is connected securely to both the charger and to AC power.
	The spare battery is not correctly seated.	Remove and reinsert the battery into the battery adapter, ensuring that it is correctly seated.
	The battery adapter is not seated properly.	Remove and reinsert the battery adapter into the charger, ensuring that it is correctly seated.
	The battery was removed from the charger or the charger was unplugged from AC power too soon.	Ensure that the charger is receiving power. Ensure that the spare battery is seated correctly. The battery charges from fully depleted to 90% in approximately 4 hours, and from fully depleted to 100% in approximately 5 hours.
	The battery is faulty.	Verify that other batteries charge properly. If so, replace the faulty battery.

Service Information

If you have a problem with your equipment, contact Zebra Global Customer Support for your region. Contact information is available at: zebra.com/support.

When contacting support, please have the following information available:

- Serial number of the unit
- Model number or product name
- Software type and version number

Zebra responds to calls by email, telephone, or fax within the time limits set forth in support agreements.

If your problem cannot be solved by Zebra Customer Support, you may need to return your equipment for servicing and will be given specific directions. Zebra is not responsible for any damages incurred during shipment if the approved shipping container is not used. Shipping the units improperly can possibly void the warranty.

If you purchased your Zebra business product from a Zebra business partner, contact that business partner for support.

Determining Software Versions

Before contacting Customer Support, determine the current software version on your device.

1. Swipe down from the Status bar with two fingers to open the Quick Access panel, and then touch .
2. Touch **About phone**.
3. Touch **Android version**.

The **Build number** displays the software version.

Determining the Serial Number

Before contacting Customer Support, determine the serial number of your device.

1. Swipe down from the Status bar with two fingers to open the Quick Access panel, and then touch .
2. Touch **About phone**.
3. Touch **Model & hardware**.
4. Touch **Serial number**.

Reading the Manufacturing Label

If the manufacturing label is worn or missing, use an NFC-enabled device to read the NFC tag under the battery compartment. Download the NFC Reader application for free from the Google Play™ store.



NOTE: This NFC device tag is different than the NFC reader on top of the device.

Figure 47 Reading the NFC Tag

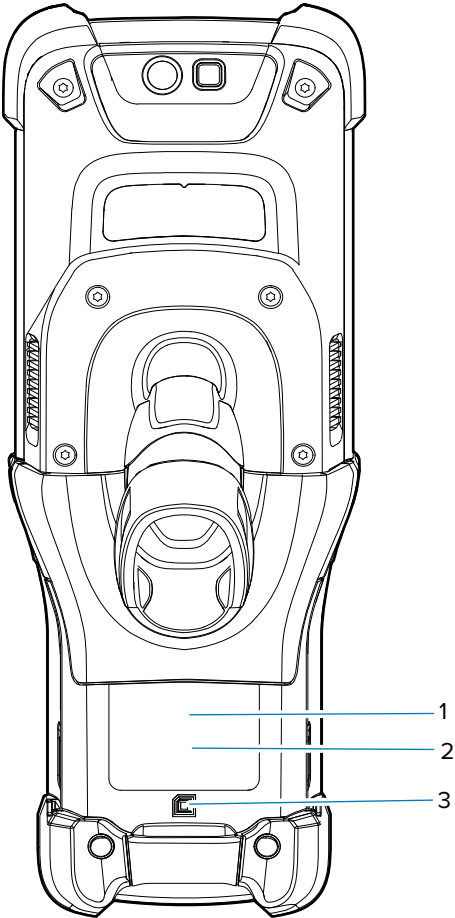

1	Manufacturing label
2	NFC tag (Inside the battery compartment)
3	NFC symbol

Specifications

For device technical specifications, go to the [MC9400 Handheld Mobile Computer Spec Sheet](#).

Configurations

The tables in this section contain the MC9400 and MC9450 configurations.

Table 39 MC9400 Configurations

Radios	Display	Memory	Data Capture Options	Operating System
MC9400 Standard				
WLAN: IEEE 802.11 a/b/g/n/ac/ax/d/h/i/r/k/v/w/mc 2x2 MU-MIMO; Tri-band (2.4 GHz, 5 GHz, 6 GHz); Wi-Fi CERTIFIED 6™ (Wi-Fi 6E); Dual Band Simultaneous; IPv4, IPv6 WPAN: Class 2, Bluetooth v5.3 Low Energy	4.3 in. WVGA (800 x 480) LCD	6 GB RAM 128 GB Flash	SE4770-SR 2D SE58 ERI 2D	Android-based, Google™ Mobile Services (GMS) 13
MC9400 Camera Package Standard + Front and Rear Facing Cameras				
WLAN: IEEE 802.11 a/b/g/n/ac/ax/d/h/i/r/k/v/w/mc 2x2 MU-MIMO; Tri-band (2.4 GHz, 5 GHz, 6 GHz); Wi-Fi CERTIFIED 6™ (Wi-Fi 6E); Dual Band Simultaneous; IPv4, IPv6 WPAN: Class 2, Bluetooth v5.3 Low Energy	4.3 in. WVGA (800 x 480) LCD	6 GB RAM 128 GB Flash	SE4770-SR 2D SE58 ERI 2D	Android-based, Google™ Mobile Services (GMS) 13
MC9400 Freezer				

Specifications

Table 39 MC9400 Configurations (Continued)

Radios	Display	Memory	Data Capture Options	Operating System
WLAN: IEEE 802.11 a/b/g/n/ac/ax/d/h/i/r/k/v/w/mc 2x2 MU-MIMO; Tri-band (2.4 GHz, 5 GHz, 6 GHz); Wi-Fi CERTIFIED 6™ (Wi-Fi 6E); Dual Band Simultaneous; IPv4, IPv6 WPAN: Class 2, Bluetooth v5.3 Low Energy	4.3 in. WVGA (800 x 480) LCD. Optically Bonded to the Touch Panel with heated touch panel	6 GB RAM 128 GB Flash	SE4770-SR 2D SE58 ERI 2D	Android-based, Google™ Mobile Services (GMS) 13
MC9400 Non-Incendive				
WLAN: IEEE 802.11 a/b/g/n/ac/ax/d/h/i/r/k/v/w/mc 2x2 MU-MIMO; Tri-band (2.4 GHz, 5 GHz, 6 GHz); Wi-Fi CERTIFIED 6™ (Wi-Fi 6E); Dual Band Simultaneous; IPv4, IPv6 WPAN: Class 2, Bluetooth v5.3 Low Energy	4.3 in. WVGA (800 x 480) LCD.	6 GB RAM 128 GB Flash	SE4770-SR 2D SE58 ERI 2D	Android-based, Google™ Mobile Services (GMS) 13
MC9400 Non-Incendive Camera Package Non-Incendive + Front and Rear Facing Cameras				
WLAN: IEEE 802.11 a/b/g/n/ac/ax/d/h/i/r/k/v/w/mc; 2x2 MU-MIMO; Tri-band (2.4 GHz, 5 GHz, 6 GHz); Wi-Fi CERTIFIED 6™ (Wi-Fi 6E); Dual Band Simultaneous; IPv4, IPv6 WPAN: Class 2, Bluetooth v5.3 Low Energy	4.3 in. WVGA (800 x 480) LCD.	6 GB RAM 128 GB Flash	SE4770-SR 2D SE58 ERI 2D	Android-based, Google™ Mobile Services (GMS) 13

Table 40 MC9450 Configurations

Radios	Display	Memory	Data Capture Options	Operating System
MC9450 Standard				

Table 40 MC9450 Configurations (Continued)

Radios	Display	Memory	Data Capture Options	Operating System
WLAN: IEEE 802.11 a/b/g/n/ac/ax/d/h/i/r/k/v/w/mc 2x2 MU-MIMO; Tri-band (2.4 GHz, 5 GHz, 6 GHz); Wi-Fi CERTIFIED 6™ (Wi-Fi 6E); Dual Band Simultaneous; IPv4, IPv6 WPAN: Class 2, Bluetooth v5.3 Low Energy WWAN: 3G NA: B2/4/5; RoW: 1/2/4/5/8 4G NA: B2/4/5/7/8/12/13/14/17/25/26/29/30/38/41/48/66/71 4G RoW: B1/2/3/4/5/6/7/9/10/14/17/18/20/26/28/38/39/40/41/42/43/66/71 5G FR1 NA: n2/5/7/8/12/13/14/25/26/30/38/41/48/66/71/77/78 5G FR1 RoW: n1/2/3/5/7/8/12/18/20/26/28/38/40/41/66/71/77/78 Gigabit LTE-A 5G NR Sub-6 (NSA, SA) LTE/NR Carrier Aggregation Supports private networking (LTE/5G)	4.3 in. WVGA (800 x 480) LCD	6 GB RAM 128 GB Flash	SE4770-SR 2D SE58 ERI 2D	Android-based, Google™ Mobile Services (GMS) 13
MC9450 Camera Package Standard + Front and Rear Facing Cameras				

Table 40 MC9450 Configurations (Continued)

Radios	Display	Memory	Data Capture Options	Operating System
WLAN: IEEE 802.11 a/b/g/n/ac/ax/d/h/i/r/k/v/w/mc 2x2 MU-MIMO; Tri-band (2.4 GHz, 5 GHz, 6 GHz); Wi-Fi CERTIFIED 6™ (Wi-Fi 6E); Dual Band Simultaneous; IPv4, IPv6 WPAN: Class 2, Bluetooth v5.3 Low Energy WWAN: 3G NA: B2/4/5; RoW: 1/2/4/5/8 4G NA: B2/4/5/7/8/12/13/14/17/25/26/29/30/38/41/48/66/71 4G RoW: B1/2/3/4/5/6/7/9/10/14/17/18/20/26/28/38/39/40/41/42/43/66/71 5G FR1 NA: n2/5/7/8/12/13/14/25/26/30/38/41/48/66/71/77/78 5G FR1 RoW: n1/2/3/5/7/8/12/18/20/26/28/38/40/41/66/71/77/78 Gigabit LTE-A 5G NR Sub-6 (NSA, SA) LTE/NR Carrier Aggregation Supports private networking (LTE/5G)	4.3 in. WVGA (800 x 480) LCD	6 GB RAM 128 GB Flash	SE4770-SR 2D SE58 ERI 2D	Android-based, Google™ Mobile Services (GMS) 13

SE4770-SR Decode Zones

This table lists the typical distances for selected barcode densities.

Table 41 SE4770-SR Decode Distances

Symbology	Typical Working Range	
	Near	Far
3 mil Code 39	7.11 cm (2.8 in)	14.73 cm (5.8 in)
5 mil Code 128	5.84 cm (2.3 in)	24.89 cm (9.8 in)
5 mil PDF417	7.62 cm (3.0 in)	20.06 cm (7.9 in)
6.67 mil PDF 417	5.58 cm (2.2 in)	25.65 cm (10.1 in)
10 mil DataMatrix	6.09 cm (2.4 in)	27.94 cm (11.0 in)
100% UPCA	4.06 cm (1.6 in)	63.24 cm (24.9 in)

Table 41 SE4770-SR Decode Distances (Continued)

Symbology	Typical Working Range	
	Near	Far
15 mil Code 128	6.09* cm (2.4 in)	70.61 cm (27.8 in)
20 mil Code 39	4.06 cm (1.6 in)	91.69 cm (36.1 in)
20 mil QR	2.79 cm (1.1 in)	44.45 cm (17.5 in)
* Limited by width of barcode in field of view. Refer to the SE4770 Integration Guide for details. Photographic quality barcode at 18° tilt pitch angle under 30 fcd ambient illumination. Distances measured from the front edge of the scan engine chassis.		

SE58-ER Decode Zones

This table lists the typical distances for selected barcode densities.

Table 42 SE58-ER Decode Distances

Symbology	Typical Working Range	
	Near	Far
5 mil Code 39 2.5:1	51 mm (2.0 in.)	1.50 m (59 in.)
5 mil PDF	89 mm (3.5 in.)	1.09 m (43 in.)
6.67 mil PDF	71 mm (2.8 in.)	1.45 m (57 in.)
10 mil PDF	48 mm (1.9 in.)	1.96 m (77 in.)
10 mil Data Matrix	61 mm (2.4 in.)	1.57 m (62 in.)
10 mil QR	61 mm (2.4 in.)	1.42 m (56 in.)
80% UPCA	48 mm (1.9 in.)	2.79 m (110 in.)
100% UPCA	56 mm (2.2 in.)	3.53 m (139 in.)
15 mil Code 128 4 in. wide	147 mm (5.8 in.)	4.04 m (159 in.)
20 mil Code 39 2.2:1	*	5.84 m (230 in.)
40 mil Code 39 2.5:1	*	12.47 m (491 in.)
55 mil Code 39 3:1	*	17.8 m (702 in.)
55 mil QR	*	7.37 m (290 in.)
100 mil Code 39, 3:1, 203 mm (8 in.) height	*	32.7 m (1286 in.)
100 mil Code 39, 3:1 RFL, 152 mm (6 in.) height	*	30.9 m (1217 in.)
100 mil C128 RFL, 152 mm (6 in.) height	*	25.6 m (1006 in.)
* Limited by width of barcode in field of view. Refer to the SE58 Integration Guide for details. Photographic quality barcode at 18° tilt pitch angle under 20 fcd ambient illumination. Distances measured from the front edge of the scan engine chassis.		

Accessory Specifications

This section provides the specifications for the device's accessories.

1-Slot USB Charge Cradle with Spare Battery Charger Technical Specifications

This section provides technical specifications for the 1-slot USB Charge Cradle and the Spare Battery Charger.

Table 43 1-Slot USB Charge Cradle with Spare Battery Charger Technical Specifications

Item	Description
Dimensions	Height: 87.9 mm (3.46 in) Width: 152.4 mm (6.00 in) Depth: 159.4 mm (6.28 in)
Weight	522 g (18.41 oz)
Input Voltage	12 VDC
Power Consumption	28 watts
Operating Temperature	0°C to 40°C (32°F to 104°F)
Storage Temperature	-40°C to 70°C (-40°F to 158°F)
Charging Temperature	0°C to 40°C (32°F to 104°F)
Humidity	5% to 95% non-condensing
Drop	75 cm (30 in.) to concrete; 2 drops/side for a total of 12 drops at room temperature (23°C).
Electrostatic Discharge (ESD)	+/- 15 kV air +/- 8 kV contact +/- 8 kV indirect discharge

4-Slot Charge Only ShareCradle Technical Specifications

This section provides technical specifications for the 4-Slot Charge Only ShareCradle.

Table 44 4-Slot Charge Only ShareCradle Technical Specifications

Item	Description
Dimensions	Height: 116.5 mm (4.59 in) Width: 152.4 mm (6.00 in) Depth: 132.7 mm (5.22 in)
Weight	1879 g (66.28 oz)
Input Voltage	12 VDC
Power Consumption	63 watts
Operating Temperature	0°C to 40°C (32°F to 104°F)

Table 44 4-Slot Charge Only ShareCradle Technical Specifications (Continued)

Item	Description
Storage Temperature	-40°C to 70°C (-40°F to 158°F)
Charging Temperature	0°C to 40°C (32°F to 104°F)
Humidity	5% to 95% non-condensing
Drop	75 cm (30 in.) to concrete; 2 drops/side for a total of 12 drops at room temperature (23°C).
Electrostatic Discharge (ESD)	+/- 15 kV air +/- 8 kV contact +/- 8 kV indirect discharge

4-Slot Ethernet ShareCradle Technical Specifications

This section provides technical specifications for the 4-Slot Ethernet ShareCradle.

Table 45 4-Slot Ethernet ShareCradle Technical Specifications

Item	Description
Dimensions	Height: 116.5 mm (4.59 in) Width: 489.0 mm (19.25 in.) Depth: 132.7 mm (5.22 in)
Weight	2070 g (37.67 oz)
Input Voltage	12 VDC
Power Consumption	80 watts
Operating Temperature	0°C to 40°C (32°F to 104°F)
Storage Temperature	-40°C to 70°C (-40°F to 158°F)
Charging Temperature	0°C to 40°C (32°F to 104°F)
Humidity	5% to 95% non-condensing
Drop	75 cm (30 in.) to concrete; 2 drops/side for a total of 12 drops at room temperature (23°C).
Electrostatic Discharge (ESD)	+/- 15 kV air +/- 8 kV contact +/- 8 kV indirect discharge

4-Slot Spare Battery Charger Technical Specifications

This section provides technical specifications for the 4-Slot Spare Battery Charger.

Table 46 4-Slot Spare Battery Charger Technical Specifications

Item	Description
Dimensions	Height: 104.4 mm (4.11 in.) Width: 121.9 mm (4.80 in.) Depth: 142.4 mm (5.61 in.)
Weight	619.3 g (21.85 oz)
Input Voltage	12 VDC
Power Consumption	30 watts
Operating Temperature	0°C to 40°C (32°F to 104°F)
Storage Temperature	-40°C to 70°C (-40°F to 158°F)
Charging Temperature	0°C to 40°C (32°F to 104°F)
Humidity	5% to 95% non-condensing
Drop	75 cm (30 in.) to concrete; 2 drops/side for a total of 12 drops at room temperature (23°C).
Electrostatic Discharge (ESD)	+/- 15 kV air +/- 8 kV contact +/- 8 kV indirect discharge

16-Slot Spare Battery Charger Technical Specifications

This section provides technical specifications for the 16-Slot Spare Battery Charger.

Table 47 16-Slot Spare Battery Charger Technical Specifications

Item	Description
Dimensions	Height: 104.9 mm (4.13 in.) Width: 489.0 mm (19.25 in.) Depth: 142.4 mm (5.61 in.)
Weight	2480 g (87.48 oz)
Input Voltage	12 VDC
Power Consumption	106 watts
Operating Temperature	0°C to 40°C (32°F to 104°F)
Storage Temperature	-40°C to 70°C (-40°F to 158°F)
Charging Temperature	0°C to 40°C (32°F to 104°F)
Humidity	5% to 95% non-condensing

Table 47 16-Slot Spare Battery Charger Technical Specifications (Continued)

Item	Description
Drop	75 cm (30 in.) to concrete; 2 drops/side for a total of 12 drops at room temperature (23°C).
Electrostatic Discharge (ESD)	+/- 15 kV air +/- 8 kV contact +/- 8 kV indirect discharge

USB Charge/Com Snap-on Cup Technical Specifications

This section provides technical specifications for the USB charge/communications Snap-on Cup.

Table 48 USB Charge Cable Technical Specifications

Item	Description
Dimensions	Height: 55.8 mm (2.19 in.) Width (with cable): 199.5 mm (7.85 in.) Depth 52.8 mm (2.07 in.)
Weight	76.1 g (2.68 oz)
Input Voltage	5 VDC
Power Consumption	12 watts
Operating Temperature	0°C to 50°C (32°F to 104°F)
Storage Temperature	-40°C to 70°C (-40°F to 158°F)
Charging Temperature	0°C to 40°C (32°F to 104°F)
Humidity	5% to 95% non-condensing
Drop	75 cm (30 in.) to concrete; 2 drops/side for a total of 12 drops at room temperature (23°C).
Electrostatic Discharge (ESD)	+/- 15 kV air +/- 8 kV contact +/- 8 kV indirect discharge

