

RFD90 Ultra- Rugged UHF RFID Sled



ZEBRA

Product Reference Guide

ZEBRA and the stylized Zebra head are trademarks of Zebra Technologies Corporation, registered in many jurisdictions worldwide. All other trademarks are the property of their respective owners. ©2022 Zebra Technologies Corporation and/or its affiliates. All rights reserved.

Information in this document is subject to change without notice. The software described in this document is furnished under a license agreement or nondisclosure agreement. The software may be used or copied only in accordance with the terms of those agreements.

For further information regarding legal and proprietary statements, please go to:

SOFTWARE: zebra.com/linkoslegal.

COPYRIGHTS: zebra.com/copyright.

WARRANTY: zebra.com/warranty.

END USER LICENSE AGREEMENT: zebra.com/eula.

Terms of Use

Proprietary Statement

This manual contains proprietary information of Zebra Technologies Corporation and its subsidiaries ("Zebra Technologies"). It is intended solely for the information and use of parties operating and maintaining the equipment described herein. Such proprietary information may not be used, reproduced, or disclosed to any other parties for any other purpose without the express, written permission of Zebra Technologies.

Product Improvements

Continuous improvement of products is a policy of Zebra Technologies. All specifications and designs are subject to change without notice.

Liability Disclaimer

Zebra Technologies takes steps to ensure that its published Engineering specifications and manuals are correct; however, errors do occur. Zebra Technologies reserves the right to correct any such errors and disclaims liability resulting therefrom.

Limitation of Liability

In no event shall Zebra Technologies or anyone else involved in the creation, production, or delivery of the accompanying product (including hardware and software) be liable for any damages whatsoever (including, without limitation, consequential damages including loss of business profits, business interruption, or loss of business information) arising out of the use of, the results of use of, or inability to use such product, even if Zebra Technologies has been advised of the possibility of such damages. Some jurisdictions do not allow the exclusion or limitation of incidental or consequential damages, so the above limitation or exclusion may not apply to you.

Contents

About this Document.....	6
Notational Conventions.....	6
Service Information.....	6
Getting Started.....	8
Unpacking.....	8
Adaptor Installation.....	9
RFD9030 Standard-Range Ultra-Rugged UHF RFID Sled Features.....	10
RFD9090 Long-Range Ultra-Rugged UHF RFID Sled.....	12
Device Installation.....	12
Device Removal.....	13
Battery Replacement.....	14
Battery Installation.....	15
Pairing the Sled with a Mobile Computer.....	15
Charging.....	17
UI Indicators.....	17
LED Definitions.....	17
Beeper Indications.....	18
Trigger Modes.....	20
Basic Data Formatting.....	20
123RFID Mobile Application.....	25
123RFID Mobile Application for Android.....	25
Installing the 123RFID Mobile Application for Android.....	25
Using the 123RFID Mobile Application for Android.....	26

Navigating 123RFID Mobile.....	26
Readers List (Available vs. Connected).....	27
RFID Operations.....	30
Rapid Read.....	31
Inventory.....	32
Locate Tag.....	45
Locate a Single Tag.....	45
Locate Multiple Tags (Multi Tag).....	46
Pre Filters.....	47
Tag Write.....	49
Read/Write.....	49
Lock.....	51
Kill.....	52
Settings.....	53
General Settings.....	54
RFID Settings.....	64
Application Settings.....	80
Scan Settings.....	81
Getting Help.....	82
123RFID Desktop Application.....	84
Application Features.....	84
Connect.....	85
Read.....	86
Reader Configuration.....	87
Reader Name.....	89
Parameter Settings.....	90
Scanning Configuration.....	90
RFID Configuration (Offline).....	91
Configuring the Timeout Setting.....	94
Print Configuration.....	96
Bluetooth Settings.....	96
Firmware Management.....	99
Connecting to the Multi-Slot Cradle.....	101

Configuration Creation.....103

Maintenance.....106

 Harmful Ingredients..... 106

 Tolerable Industrial Fluids and Chemicals..... 107

 Cleaning the Sled..... 107

Technical Specifications.....109

Troubleshooting..... 110

About this Document

This document provides information on using the RFD9030 Ultra-Rugged Standard-Range UHF RFID sled and the RFD9090 Long-Range Ultra-Rugged UHF RFID sled.

Notational Conventions

The following conventions are used in this document:

Bold text is used to highlight the following:

- Dialog box, window, and screen names.
- Drop-down list and list box names.
- Checkbox and radio button names.
- Checkbox and radio button names.
- Icons on a screen.
- Key names on a keypad.
- Button names on a screen.

Bullets (•) indicate:

- Action items.
- List of alternatives.
- Lists of required steps that are not necessarily sequential.

Sequential lists (for example, those that describe step-by-step procedures) appear as numbered lists.

Service Information

If you have a problem with your equipment, contact Zebra Global Customer Support for your region. Contact information is available at: zebra.com/support.

When contacting support, please have the following information available:

- Serial number of the unit
- Model number or product name
- Software type and version number

Zebra responds to calls by email, telephone, or fax within the time limits outlined in support agreements.

About this Document

If your problem cannot be solved by Zebra Customer Support, you may need to return your equipment for servicing and will be given specific directions. Zebra is not responsible for any damages incurred during shipment if the approved shipping container is not used. Shipping the units improperly can void the warranty.

If you purchased your Zebra business product from a Zebra business partner, contact that business partner for support.

Getting Started

The RFD90 Ultra-Rugged UHF RFID sled provides RAIN Radio Frequency Identification (RFID) tag reading, writing, and locating capability to support Zebra mobile computers and other host devices. This section provides information on sled features, adaptor installation, mobile computer attachment, battery replacement, UI indications, and charging.

To use the RFD90 sled for the first time with a mobile computer:

1. Insert the battery into the device.
2. Charge the RFD90 sled using the charging cradle or charging cup.
3. Replace the cover with the adaptor that is specific to the mobile computer to be used with the sled.
4. Place the mobile computer into the adaptor bottom first.
5. Secure the mobile computer into the adaptor by pressing down on the center of the top of the mobile computer.
6. Set the region using 123RFID Desktop or 123RFID Mobile applications.

For the latest versions of guides and software, go to: zebra.com/support.

For detailed information, refer to the Product Reference Guide at: zebra.com/support.

Unpacking

This section provides information on Zebra RFD90 Ultra-Rugged UHF RFID Sled sled parts, battery installation, mobile device attachment, LED indications, and charging. Carefully remove all protective material from the RFD90 Ultra-Rugged sled and save the shipping container for later storage and shipping.

Verify the following items are in the box:

- RFD90 Ultra-Rugged UHF RFID Sled
- Battery
- Quick Start Guide

Inspect the equipment for damage. If any equipment is missing or damaged, contact the Zebra Support Center immediately.

For a full list of accessories that can be used with the RFD90 Ultra-Rugged UHF RFID sled, refer to the product-specific Technical Accessory Guide available at: zebra.com/support.

Adaptor Installation

To install an adaptor:

1. Remove the cover by pulling up on the lip.



2. Ensure that the pogo pins are aligned and insert the adaptor into the sled.



NOTE: When installing the adaptor, use caution and ensure that the pogo pins are lined up directly prior to insertion

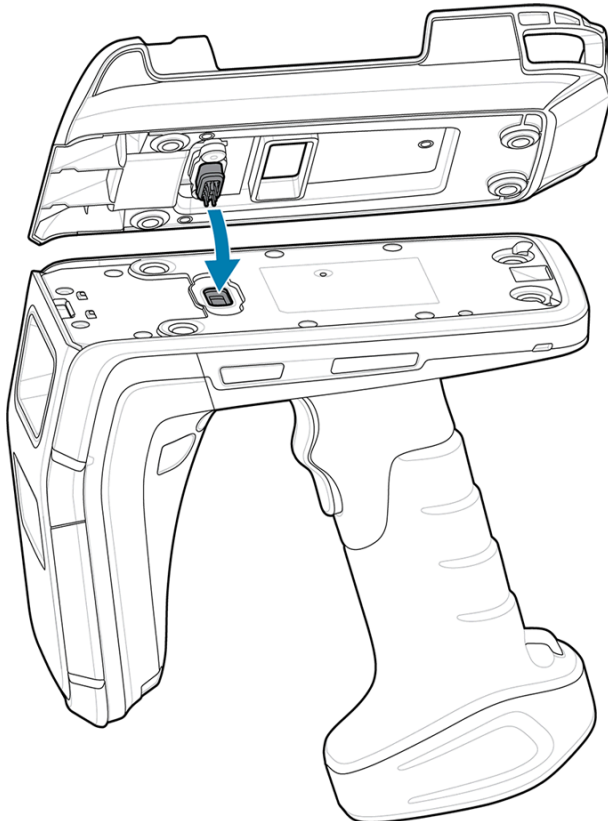

- 3. Secure the adaptor onto the RFD90 by fastening the four screws into the sled. Recommended Torque: 2.5 kgf-cm (14 ibf/in.).

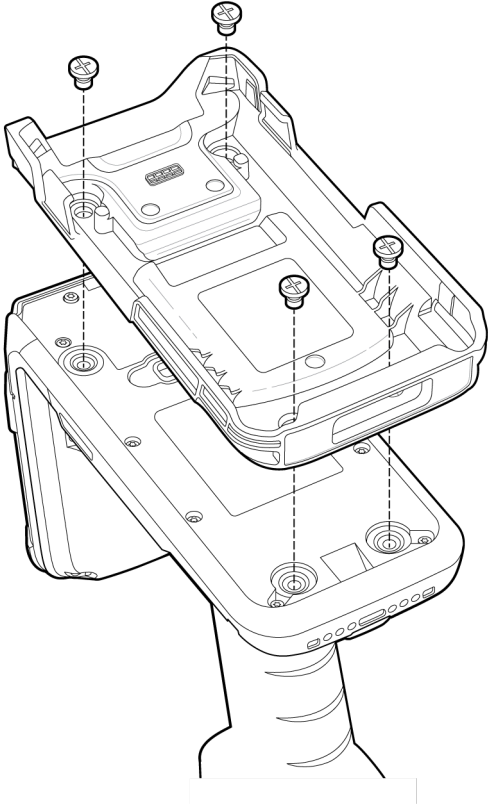

RFD9030 Standard-Range Ultra-Rugged UHF RFID Sled Features

Figure 1 RFD9030 Standard-Range Ultra-Rugged UHF RFID Features

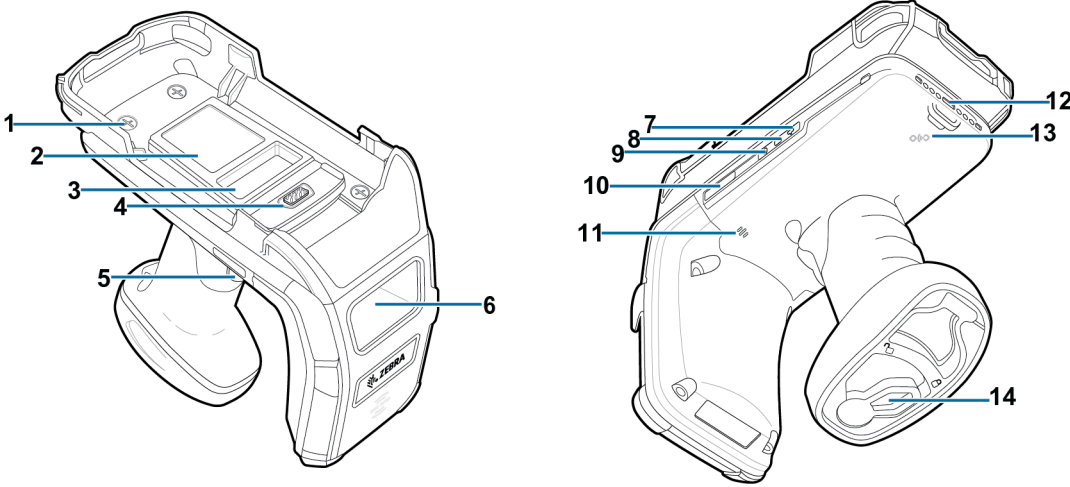

Table 1 RFD9030 Standard-Range Ultra-Rugged UHF RFID Sled Features

Item	Description
1	Screws (4)
2	Adaptor Label
3	Sled Label
4	eConnex Communication Port (available on eConnex-enabled adaptors only)
5	Tri-Function Trigger
6	Imager
7	Wi-Fi Status LED
8	Battery Status LED
9	Bluetooth LED
10	Status LED
11	Beeper
12	Charging Contacts
13	NFC Area
14	Battery Door Lock

RFD9090 Long-Range Ultra-Rugged UHF RFID Sled

The RFD9090 RFID Long Range Ultra-Rugged UHF RFID sled has the capacity to decode symbologies from an extended distance.

Figure 2 RFD9090 Long Range Ultra-Rugged UHF RFID Sled

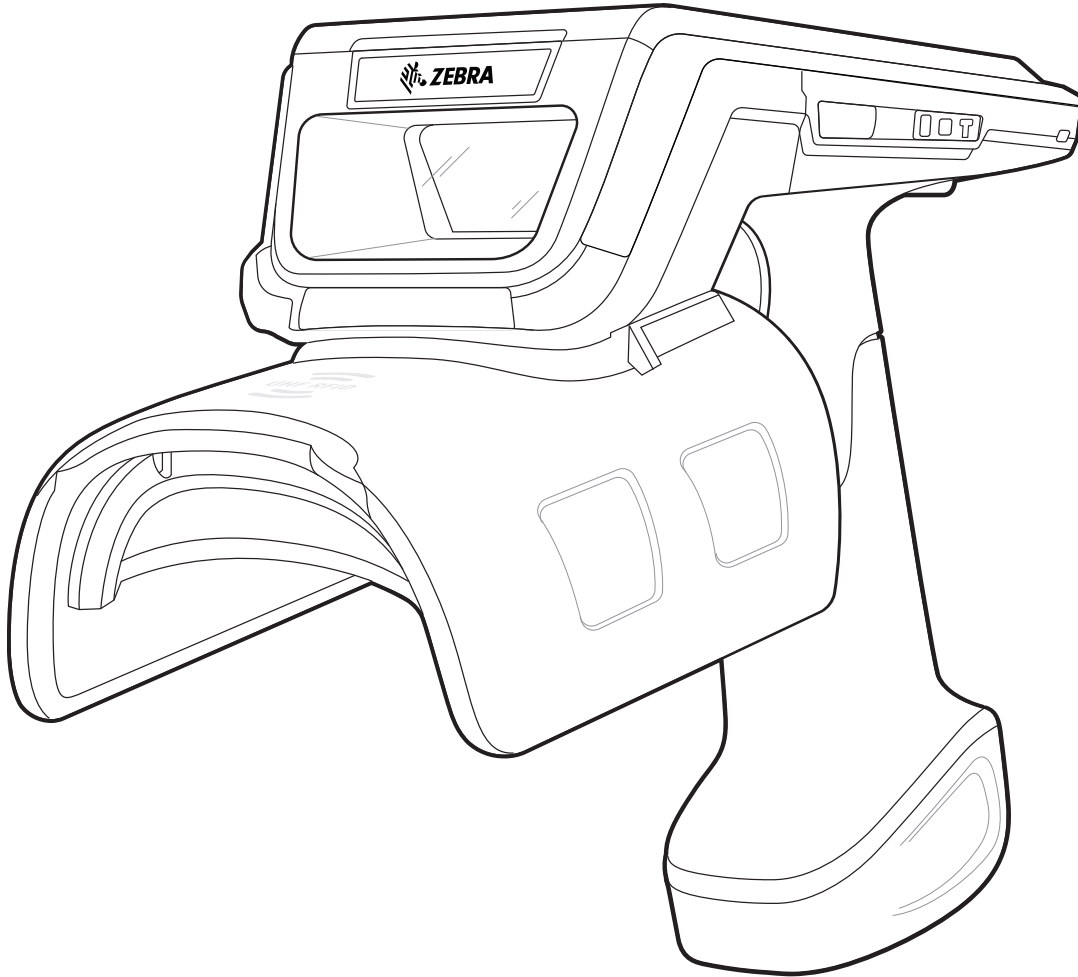

Device Installation

To secure the mobile computer to the RFD90 sled, place the bottom of the device fully forward into the RFD90 sled adaptor and push on the top center of the mobile computer to secure it.



NOTE: While installing the mobile computer into the adaptor, use caution and do not collide with the pogo pins on the RFD90.

Figure 3 Device Installation

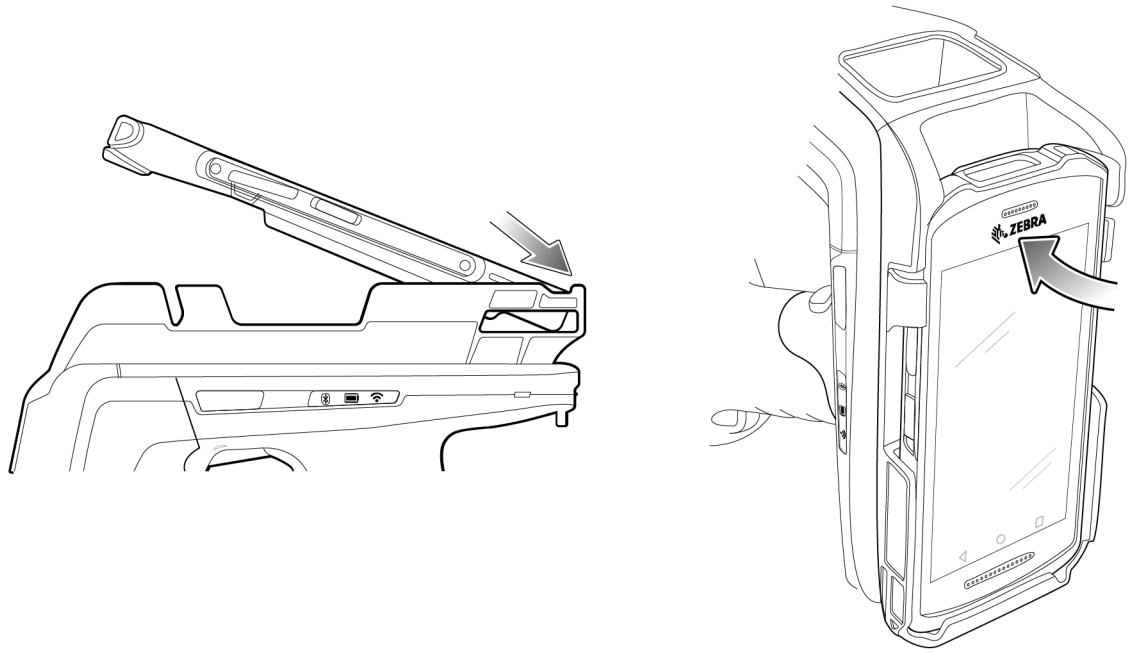

Device Removal

To remove the mobile computer from the sled, firmly hold the sled handle, and lift the device off the sled adaptor.



NOTE: If using a TC7 mobile computer (shown on the right in the figure below) with the RFD90 sled, press the button on the adaptor to release the mobile computer and lift the device off of the sled adaptor.

Figure 4 Device Removal

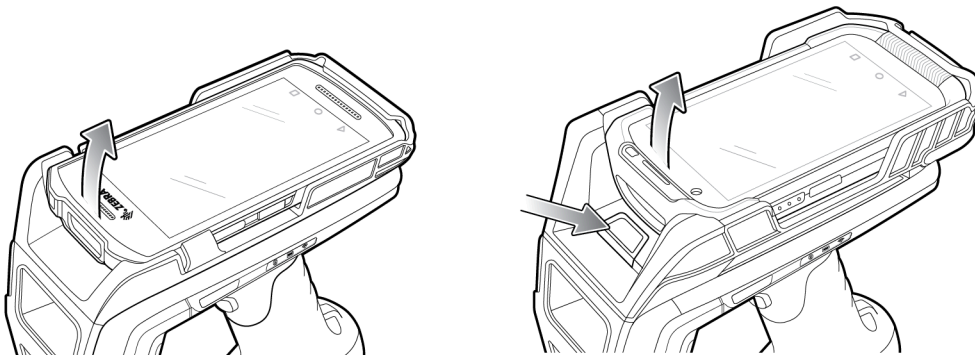

Battery Replacement

The battery that comes standard with the sled can be replaced by following the instructions outlined in this section.

To remove the battery from the sled:

Figure 5 Battery Removal

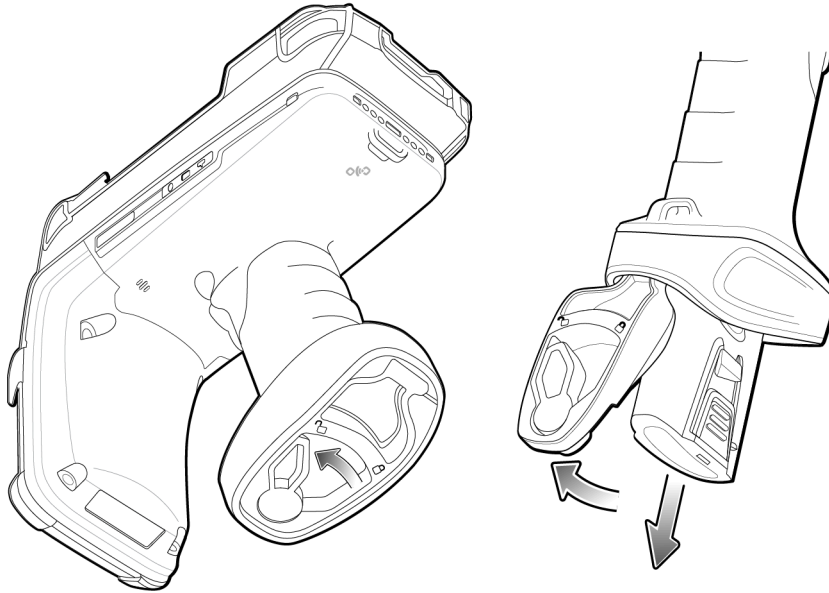

1. Slide the locking latch to the left to unlock the battery door.
2. Open the battery door.
3. Pull the battery downward to remove it.

Battery Installation

Open the battery locking door and slide the battery into the handle to install the battery into the sled. Slide the lock on the battery locking door into the locked position to lock the door and secure the battery.

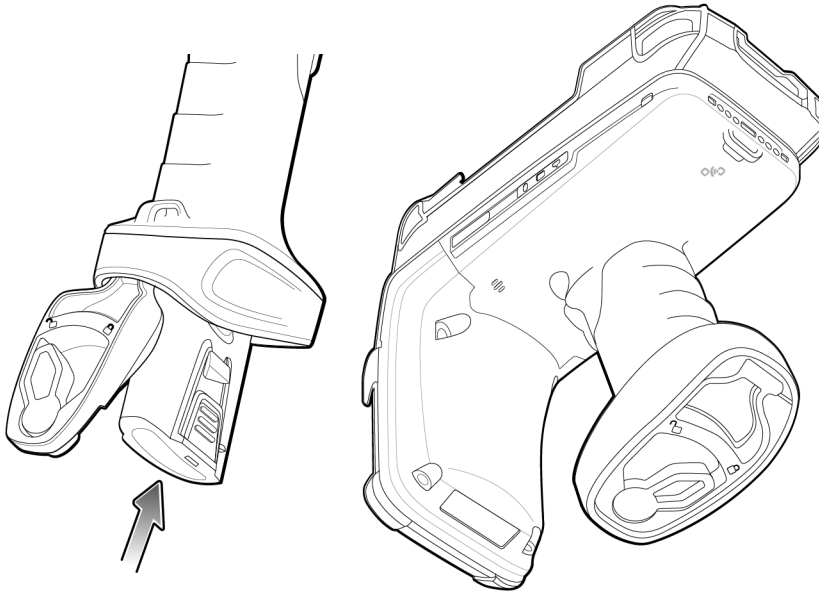

Pairing the Sled with a Mobile Computer

Pair the sled with a mobile computer by connecting directly with the communication port, scanning the 2D barcode on the device, or using the Tap-to-Pair feature on the RFD90 to activate NFC Bluetooth pairing and facilitate Bluetooth communication between the sled and the mobile computer.

- To connect via scan, scan the code on the sled using the mobile computer to obtain the Bluetooth MAC address to pair the device to the sled.

Figure 6 Scan 2D Barcode to Obtain MAC Address

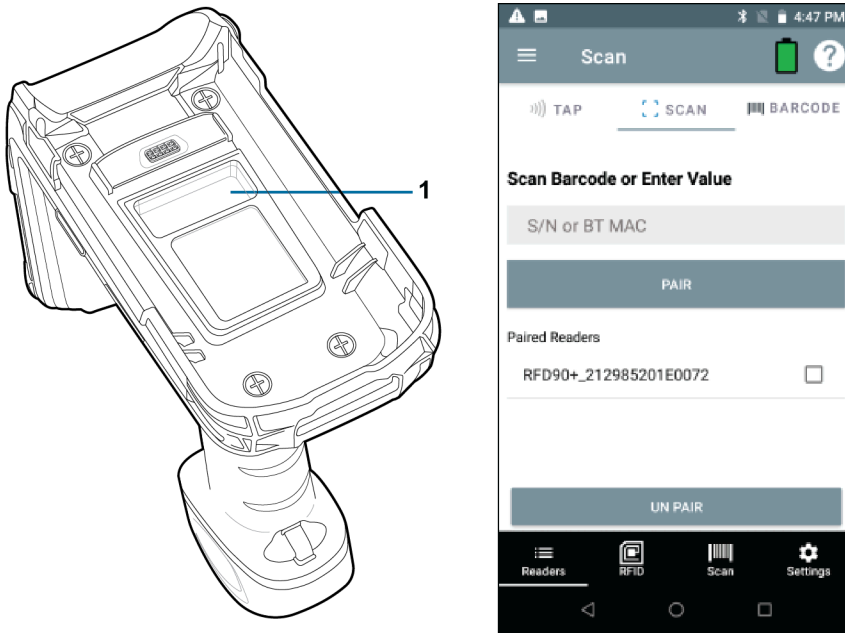

1	2D Barcode on Bluetooth Connection Manufacturing Label
---	--

- To connect via NFC, align the NFC area behind the sled handle with the NFC area on the back of the mobile computer to pair.

Figure 7 Tap-to-Pair

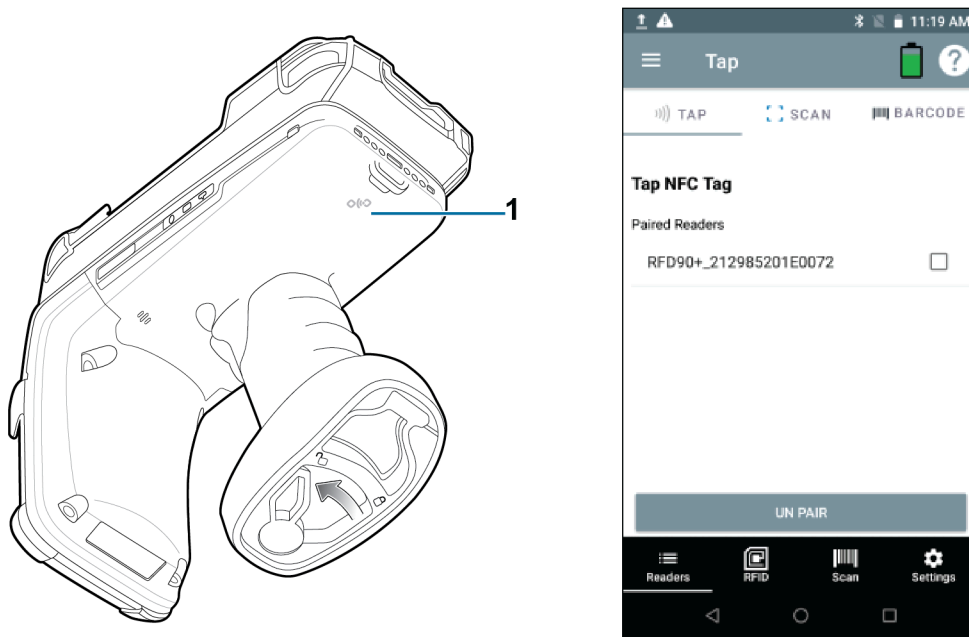

1	NFC Area
---	----------

Once the mobile computer has paired with the sled, it recognizes the device going forward and automatically connects using the 123RFID Mobile.

Charging

Before using the RFD90 RFID Ultra-Rugged UHF RFID for the first time, fully charge the battery by placing it in the charging cradle until the LED Power/Charging Indicator turns solid green.

The sled and mobile computer may be charged in the charging cradle individually or attached. The sled automatically powers on when removed from the charging cradle. The sled enters Off mode if it is idle for thirty minutes.



NOTE: The cradle does not charge the device if the battery is completely depleted.



NOTE: A 12V power supply must be connected to the power jack when charging the sled using the cable cup accessory.

UI Indicators

The sled presents multiple forms of feedback to inform the user of various device states. The sled provides LED definitions for decode and battery status as well as beeper indications to indicate battery charge progress.

LED Definitions

The sled provides user feedback in the form of LED indications for decode, battery, Bluetooth, and Wi-Fi states.

Decode LED Definitions

The following table outlines the context in which decode LED feedback is provided and the indication that is presented for a given device state.



NOTE: The LED indicators on the sled differ from the LED indicators on the mobile computer being used with the sled.

Table 2 Decode LED Indicators

Condition	Indication
Good Scan	Green
Scan Error	Red
RFID Rag Read Indicator Enabled	Green
Read Error	Red

Battery LED Definitions

The following table outlines the context in which battery LED feedback is provided and the indication that is presented for a given device state.

Table 3 Battery LED Definitions While Charging

Conditions	Indications
Pre-charging	Amber (Fast, Fast, Slow)
Charging	Amber (Blinking)
Fully Charged	Green (Stays On)
Charging Error	Amber (Fast Blinking)

Bluetooth LED Definitions

The following table outlines the context in which Bluetooth LED feedback is provided and the indication that is presented for a given device state.

Table 4 Bluetooth LED Definitions

Condition	Indication
Looking to Pair	Blue (Blinking)
Pairing	Blue (Stays On)
Paired/Connected	Blue (Stays On)
Error	Red (Stays On)

Wi-Fi LED Definitions

The following table outlines the context in which Wi-Fi LED feedback is provided and the indication that is presented for a given device state.

Table 5 Wi-Fi LED Definitions

Condition	Indication
Connecting	Green (Blinking)
Connected	Green (Stays On)
Transmission Error/Out of Range	Red (Stays On)

Beeper Indications

The sled provides user feedback in the form of beeper tones for decode, battery, Bluetooth, and Wi-Fi states.

Decode Beeper Indications

The following table outlines the context in which beeper feedback is provided and the indication that is presented for a specific decode event

Table 6 Decode Beeper Indications

Condition	Tone
Good Decode	Short high tone

Table 6 Decode Beeper Indications (Continued)

Condition	Tone
Decode Transmission Error	No beep
Good RFID Decode	Short medium tone
RFID Error	No beep
Error Message (Other)	No beep
Sled Memory Full (Batch Mode)	Long tones for 5 seconds

Battery Beeper Indications

The following table outlines the context in which decode LED feedback is provided and the indication that is presented for a given device state.

Table 7 Battery Beeper Indications

Condition	Tone
Low Battery (20%)	Medium-length tones
Lower Battery (10%)	Short tones - repeat
Suspend	High/Medium/Low
Charging	Short tone when the charger is connected.
Fully Charged	One beep
Charging Error	Three beeps (single occurrence)
Power On	Low/Medium/High beep

Bluetooth Beeper Indications

The following table outlines the context in which beeper feedback is provided and the indication that is presented for a specific Bluetooth state.

Table 8 Bluetooth Beeper Indications

Condition	Tone
On/Not Connected	No beep
On/Pairing in Process	No beep
On/Connected	Short/Low/High
Out of Range	Short/High/Low
Pairing Error	No beep
Off	No beep

Wi-Fi Beeper Indications

The following table outlines the context in which beeper feedback is provided and the indication that is presented for specific Wi-Fi states.

Table 9 Wi-Fi Beeper Indications

Condition	Tone
On/Not Connected	No beep
On/Pairing in Process	No beep
On/Connected	Short/Low/High
Out of Range	Short/High/Low
Pairing Error	No beep
Off	No beep

Trigger Modes

The following table outlines the supported trigger functions of the RFID sled.



NOTE: By default, the device assumes the upper trigger as the RFID decode trigger and the lower trigger as the mobile computer decode trigger.

Table 10 Trigger Modes

Condition	Upper Trigger	Lower Trigger	Both Triggers	Description
RFID Start/Stop	X	-	-	User Programmable
Barcode Start/Stop	-	X	-	User Programmable
Configurable/ Signal Intent to Mobile Device	-	-	X	Feature support is determined by the mobile computer being used with the device.

Basic Data Formatting

This section provides the steps necessary to do basic data formatting for barcode scan data. The 123Scan tool is used to create parameter barcodes that perform basic data formatting. Advanced-Data formatting is not supported.



NOTE: Do not use 123Scan and 123RFID Desktop simultaneously.

Download the latest 123Scan software (version 5.3 or higher), available at: zebra.com/us/en/support-downloads/software/utilities/123scan-utility.html

1. Start by disabling passthrough mode by scanning the following parameter barcode:



2. Next, create a parameter barcode using 123Scan.
3. Create a new configuration file.
4. Select My Scanner is not connected.



NOTE: 123scan is used to create offline parameter configuration for basic data formatting only. 123Scan is not used for any of the other online/offline configurations.

5. Choose the PL5000 Imager, and select PL5000 -COMMON Models.

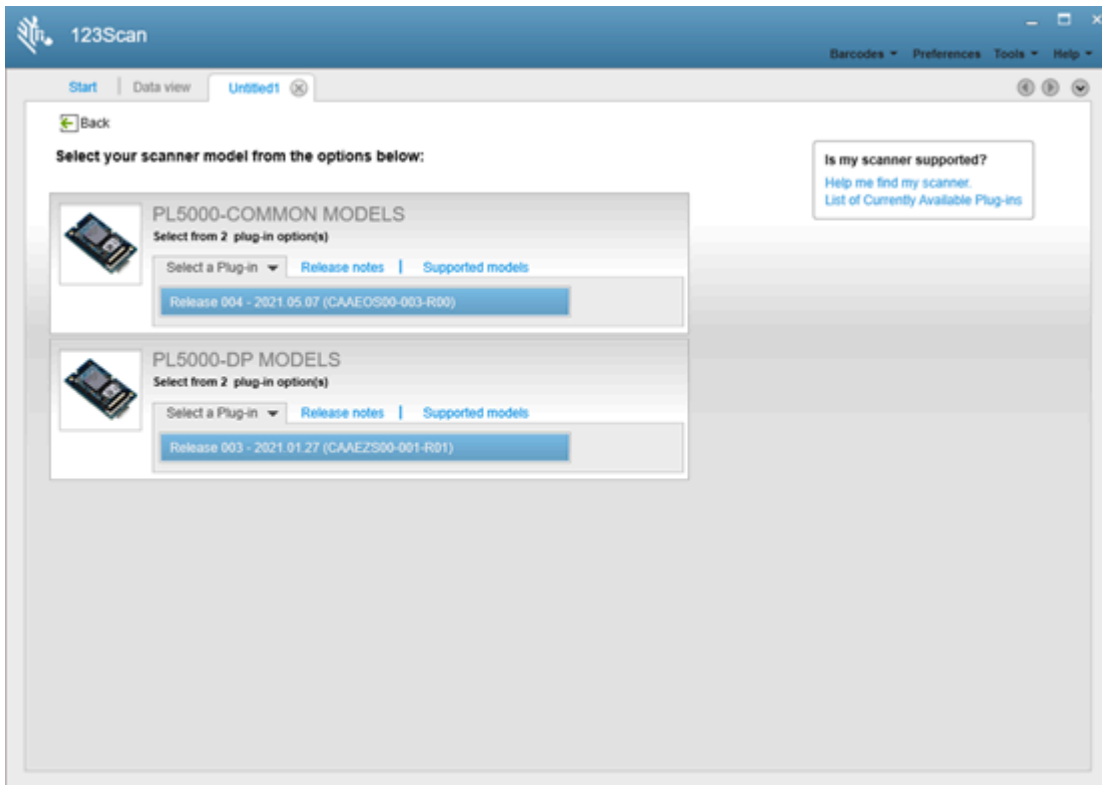

6. Select Step 4 in the configuration wizard, Modify Data.



NOTE: 123scan is used to create offline parameter configuration for basic data formatting only. As a result, Cable connection and Symbologies steps are not required for this procedure.

7. Select the Program complex data modifications or select a rule from your Data Formatting Library radio button to view Basic and Advanced options.
8. Select Basic to view or edit formatting or create a rule.

Getting Started

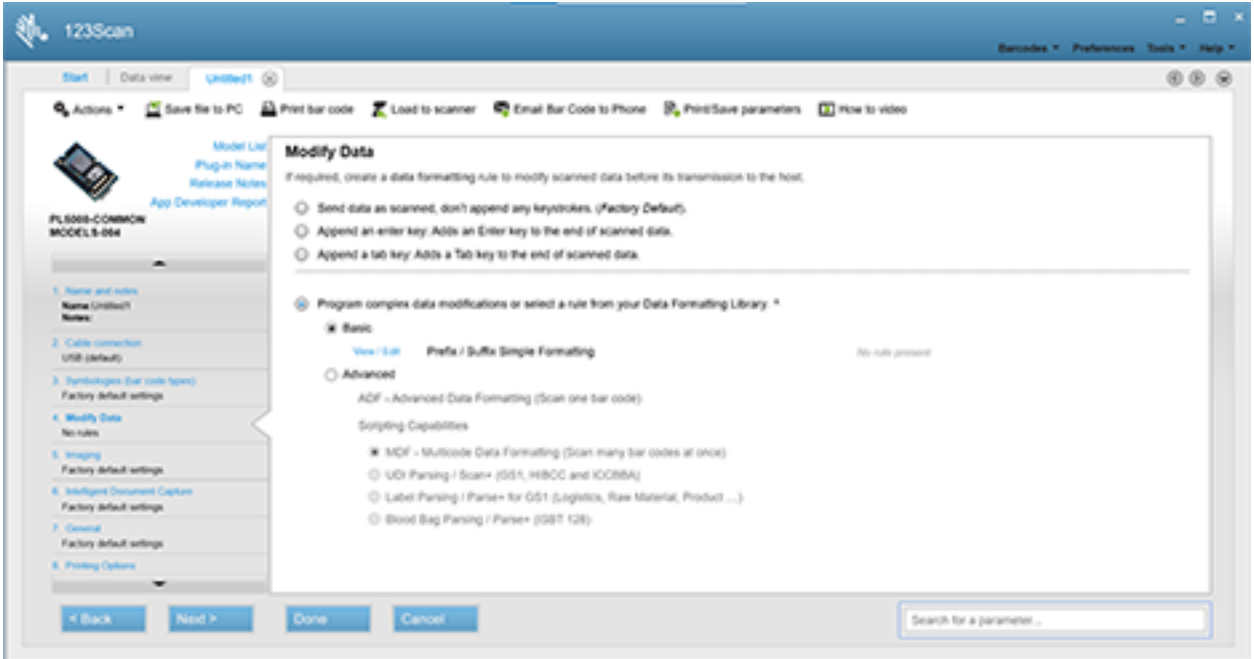

9. Click view/edit to add a new rule or edit an existing rule, and click INSERT when finished.

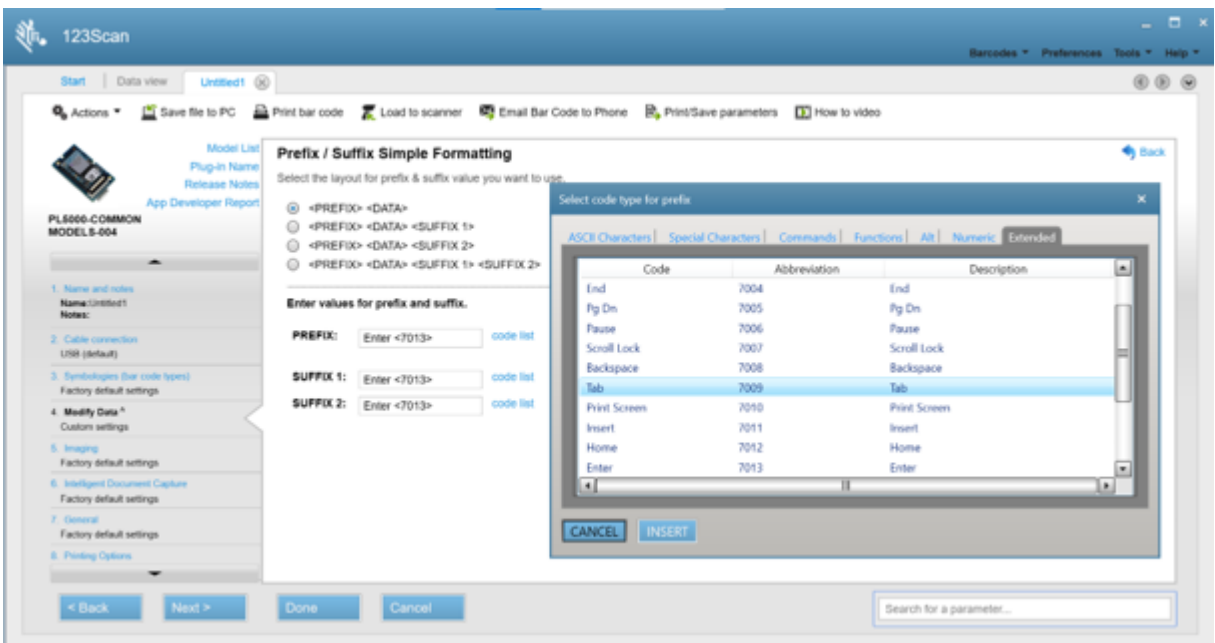

10. Observe that the intended values for prefix or suffix are added and click Done.

Getting Started

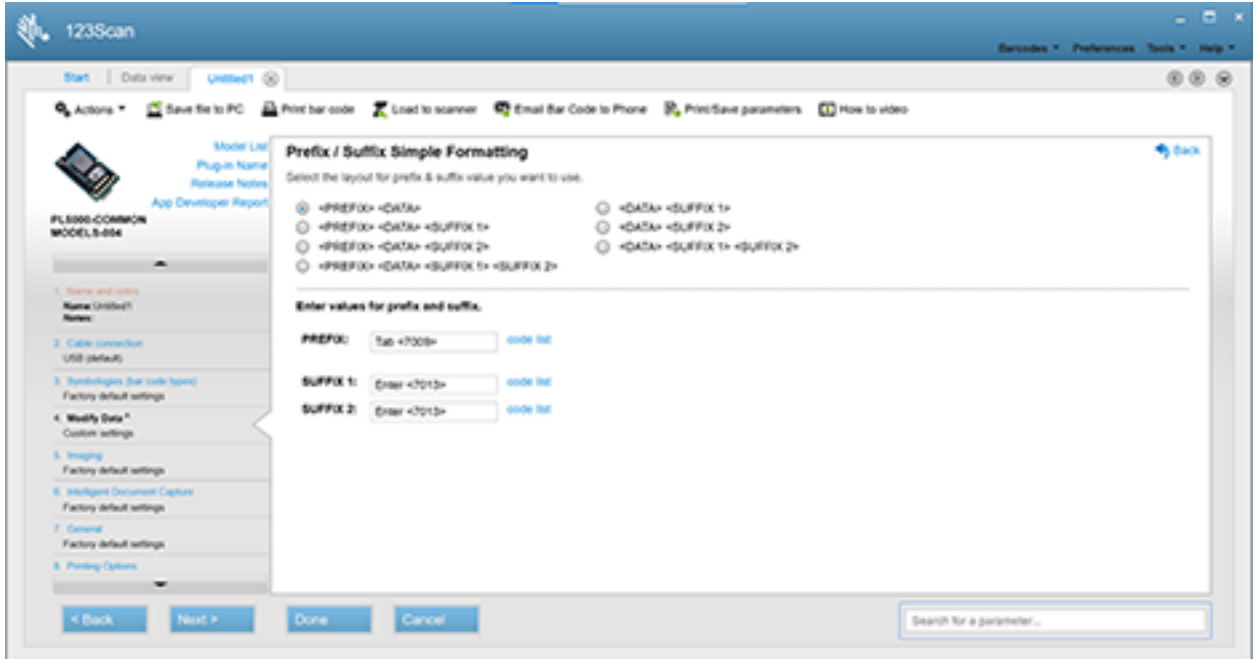

11. If the configuration file summary is correct, click Print bar code.

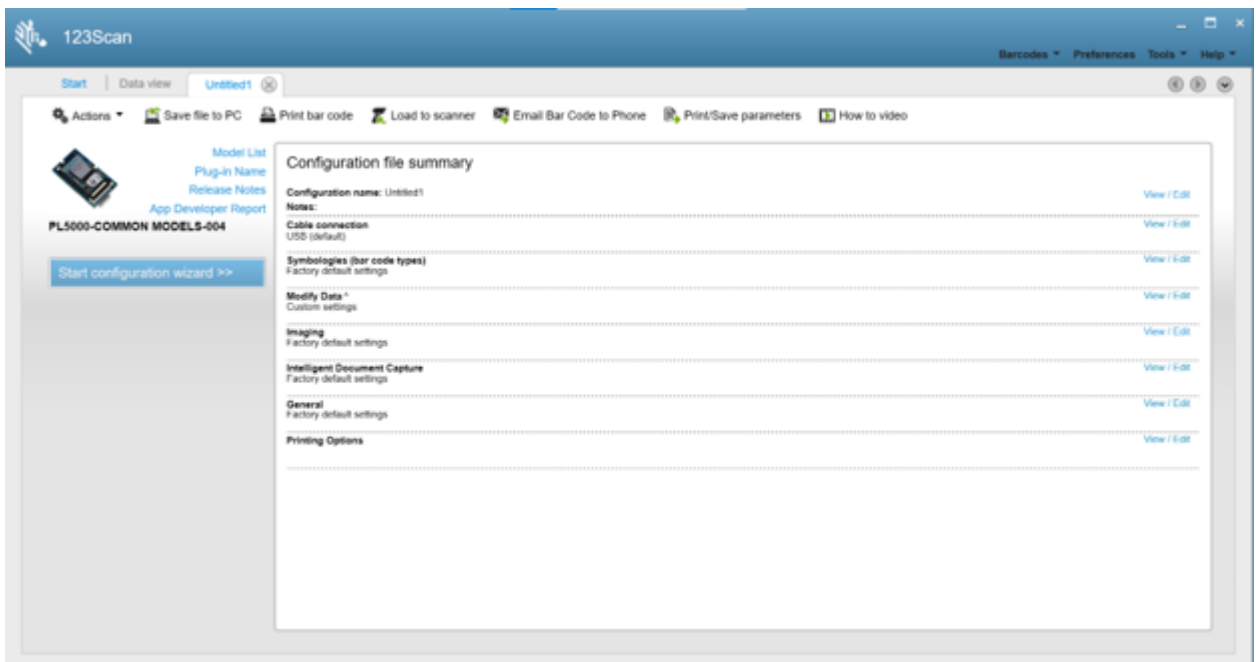

12. Users can save or print the generated parameter barcode.

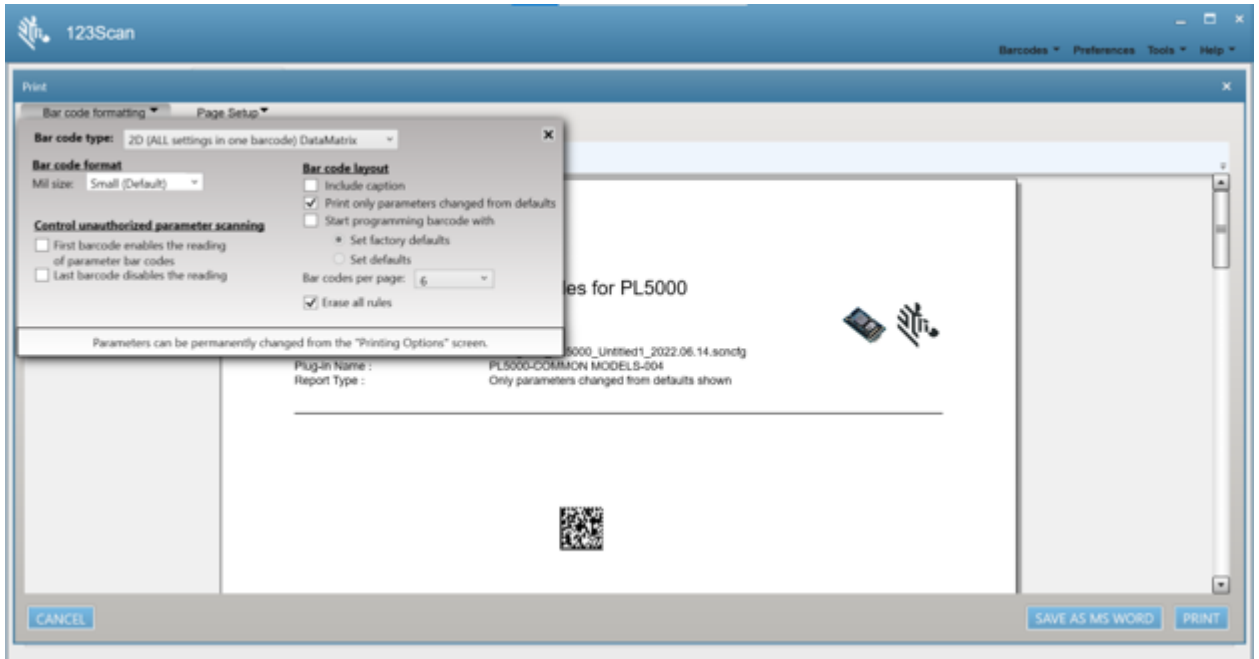

13. Scan the barcode below to re-enable passthrough mode:



123RFID Mobile Application

This chapter describes the enhanced version of the 123RFID Mobile Application for Android which demonstrates the device's capability and tag operation functionality.

This application is also available as part of Google Play store at: play.google.com/store/apps/details?id=com.zebra.rfidreaderAPI.demo&hl=en.

123RFID Mobile Application for Android

This application runs on Android mobile devices and demonstrates capability and tag operation functionality.

The application allows for navigating to all screens at any time, however, some actions are not permitted while the device is charging. These actions include any operation that involves Tag reading or writing (for example: Rapid Read, Inventory, Locate Tag, etc.).

Navigate to all screens when the inventory/locate operation is in progress. When the operation is in progress, the device displays Operation in Progress if additional operations are initiated.

Installing the 123RFID Mobile Application for Android

Install the 123RFID Mobile Application on the mobile computer from zebra.com/support or from the Google Play Store. The procedure to install the software on an Android device is dependent upon the Android version.

To install the software:

1. Connect the Android device to your computer. It is connected as MTP Device and shown as a drive on the computer.
For information on transferring files using Media Transfer Protocol, refer to the Mobile Computer Integrator Guide at: zebra.com/support.
2. Navigate to Device Settings > Security and check Unknown Sources to allow installation of applications from unknown sources.
3. Copy the 123RFID_Mobile_1.0.x.x.apk file to the mobile device.
4. Go to Settings > Security and select Unknown sources.
5. Use the File Manager to locate the 123RFID_Mobile_1.0.x.x.apk file in the folder to which it is copied in Step 3 and select it.
6. In the pop-up window, select the Android App installer to begin installation.

Using the 123RFID Mobile Application for Android

To use the application for RFID operations:

1. Launch the 123RFID Mobile Application for Android on the mobile device.
2. From the Readers list, tap on the available device listed under Available Readers to connect and view the Rapid Read screen.
3. Tap Settings > RFID > Advanced Reader Options > Antenna.

Power Level is set to 27.0 dBm by default. However, it is shown as 270 dbm because the value used is in units of tens of dBm. Japan units are set to a different default power level depending on the SKU type.

4. Tap the **Back** button and select **Regulatory** to set the region in which the device is operating.



NOTE: By default, the fastest read profile is selected and configures the reader for the maximum power allowed based on the read profile. However, the dBm can be limited due to the regulatory requirements of the specified region in which the sled is being used.

- 5.

Navigating 123RFID Mobile

Navigate using the Home screen, menu, or bottom navigation bar. Switch between the Inventory screen and the Locate screen or the Inventory screen and the Rapid Read screen with a single tap of the appropriate icon.

To exit the application, tap the Back button, and click OK on the confirmation screen.

Menu

To access the menu, tap . The menu options include:

- Readers
- Firmware Update
- Help
- Settings

To disconnect the connected reader, tap the **Disconnect** reader button.



NOTE: The battery life (% charged) displays on this screen.

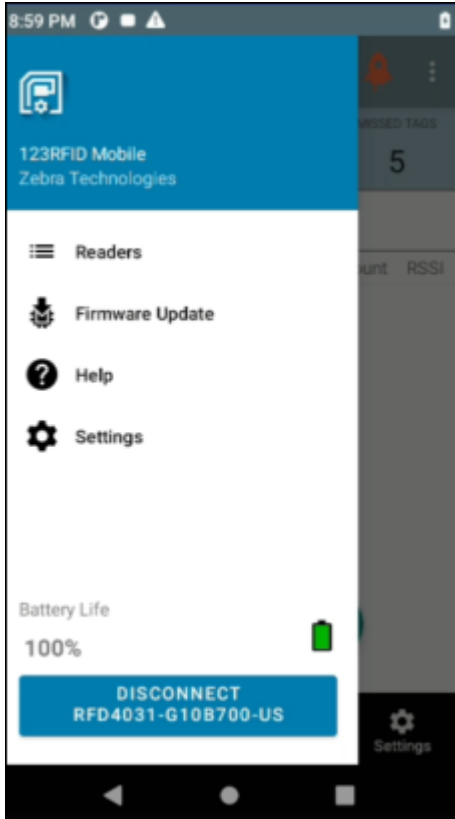

Navigation Bar

The Navigation Bar consists of the following tabs:

- **Readers** - displays a list of connected readers and available readers. Upon initial launch of the application, this is the tab that displays, unless the connection to the reader is over USB/CommonIO.
- **RFID** - select from RFID Settings, Locate Tag, Pre Filters, and Tag Write. This is the tab that displays most of the time when launching the application. If the reader has been previously connected to the app or the reader is connected over USB/Common IO.
- **Scan** - scan barcodes, view the list of scanned barcodes, or clear the scanned list.



NOTE: Available only on RFD40 Premium+ and RFD90 devices with a built-in scanner.

- **Settings** - configure General, RFID, Application, and Scan settings.

Readers List (Available vs. Connected)

The Readers list displays connected readers and available readers. After accessing 123RFID Mobile application for the first time, when no readers are available or connected, the following screen displays.

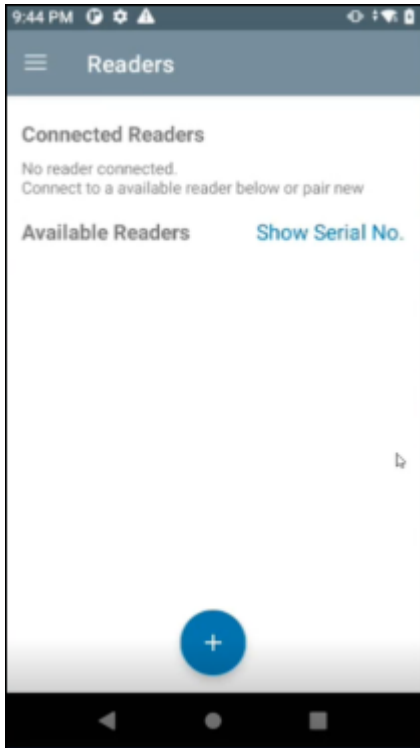

- **Connected Readers** - Lists the readers that are already connected and ready for use. Available options include:
 - Disconnect
 - Perform a firmware update
 - View reader details for a connected reader.

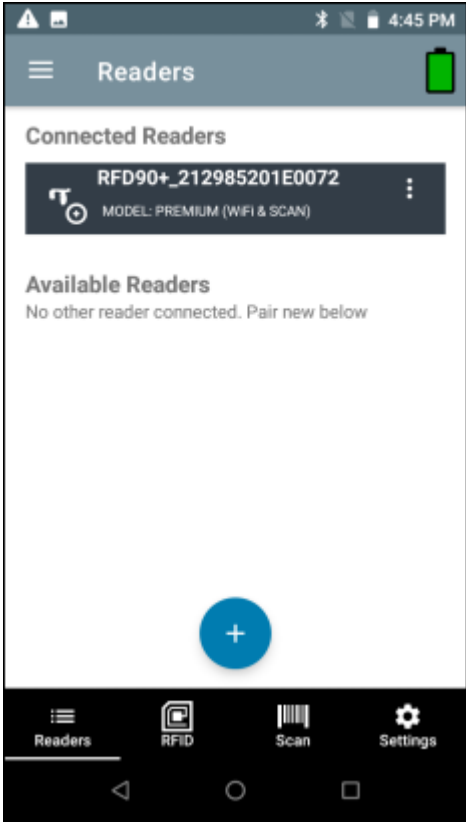

IMPORTANT: You can only connect to one device at a time.

- **Available Readers** - Lists the already paired devices that the user can choose to connect from. Available options include:
 - Connect
 - Unpair
 - View reader details for an available reader.

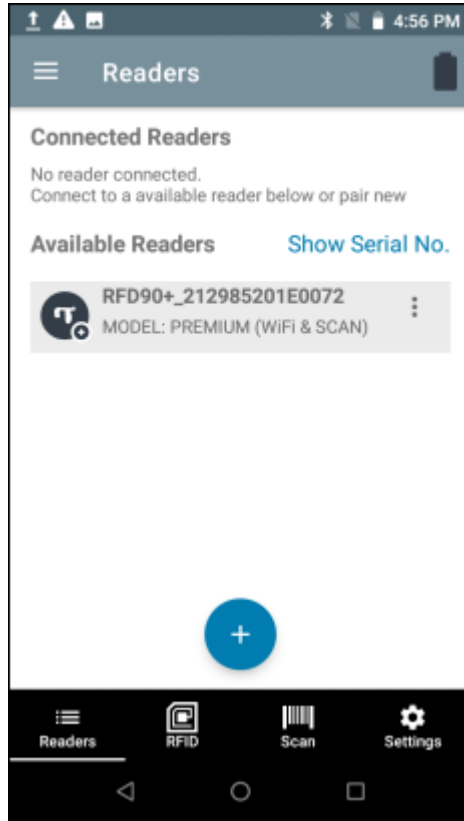

NOTE: The model name and description display under the reader name. To see the serial number, tap **Show Serial No.**

RFID Operations

Access RFID operations for the following:

- Rapid Read - Displays a view of the inventory operation on the reader, including total reads, unique tag count, tag read rate, and read time.
- Inventory - Displays tag details, once tag reading begins.
- Locate Tag - Locates a single tag or multiple tags. Can be accessed from the Inventory screen.
- Tag Write - Allows you to write data to specified tags. Can be accessed from the Inventory screen.
- Pre-Filters - Allows you to set filters for tag data. Can be accessed from the Inventory screen.
- RFID Settings - Allows you to configure specific reader and antenna settings. Can be accessed from the Rapid Read and Inventory screens, as well as from Settings.

Rapid Read

The Rapid Read screen displays the following data:

- Total Reads
- Unique tag count
- Read time (mm:ss)
- Tag read rate (tags/sec).

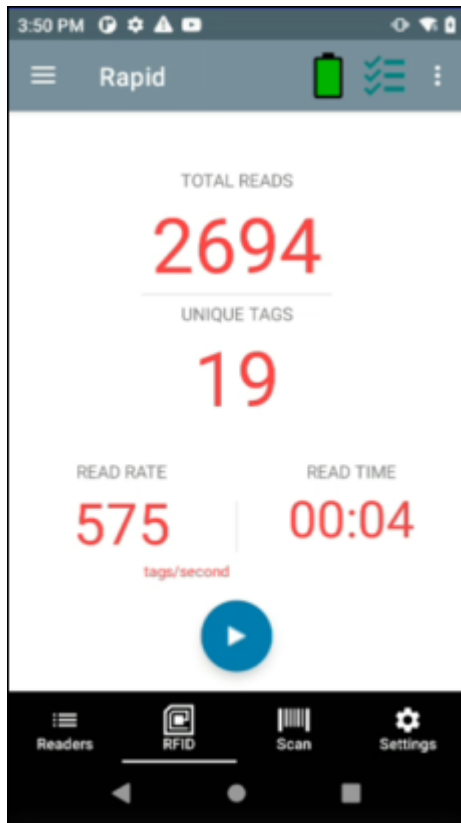

The **Rapid Read** and **Inventory** screens present two different views of the inventory operation on the reader. The Start/Stop functionality can be used interchangeably on both screens. For example, when operation starts on the Rapid Read screen and you navigate to the Inventory screen, the button available on the Inventory screen is Stop. The same is true when the operation starts on the Inventory screen. During the rapid read process, you can navigate to the Inventory screen to view tag details along with tag counts for each tag. The statistics displayed are maintained on the Rapid Read and Inventory screens regardless of the screen used to start the process.

See Also

[Inventory](#)

View Rapid Read Results

To view Rapid Read results:

1. Tap Rapid Read from the Home or Menu screen.

2. Tap Start to start the rapid read inventory operation.
3. Tap Stop to stop the inventory operation.



NOTE: The scan trigger on the device can also start and stop the inventory operation. Press the trigger to start, continue to hold and release to stop.

Progressing to another screen does not halt the operation. However, attempting to make changes or perform another operation while rapid read is in process results in an error.

Inventory

Once tags begin reading, the tag details populate the Inventory screen. Tag reading is started and stopped on this screen as well as on the Rapid Read screen. When the process starts, tag information displays on the screen.



NOTE: When the tag does not have printable ASCII data when in ASCII mode, a yellow highlighted background displays on the Inventory screen.

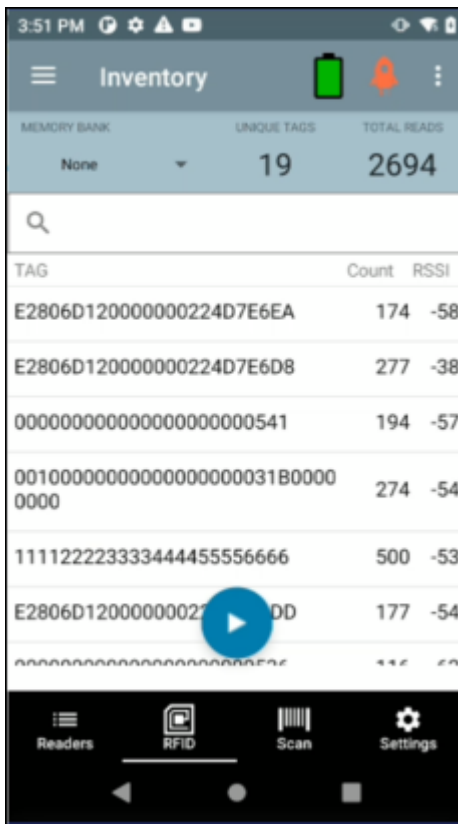

View Inventory Results

To view Inventory results:

1. Tap Inventory from the Home or Menu screen.
2. Tap Start to start the rapid read inventory operation.
The Start button changes to Stop.

3. Tap Stop to stop the read inventory operation.



NOTE: The scan trigger on the device can also start and stop the inventory operation. Press the trigger to start, continue to hold and release to stop.

4. To filter information by type, tap the Memory Bank dropdown menu and select User, Reserved, TID, or EPC.
5. The tag ID selected can be used to locate, set pre-filters and tag write. After selecting a tag, tap  and select **Locate Tag**, **Pre Filters**, or **Tag Write**.

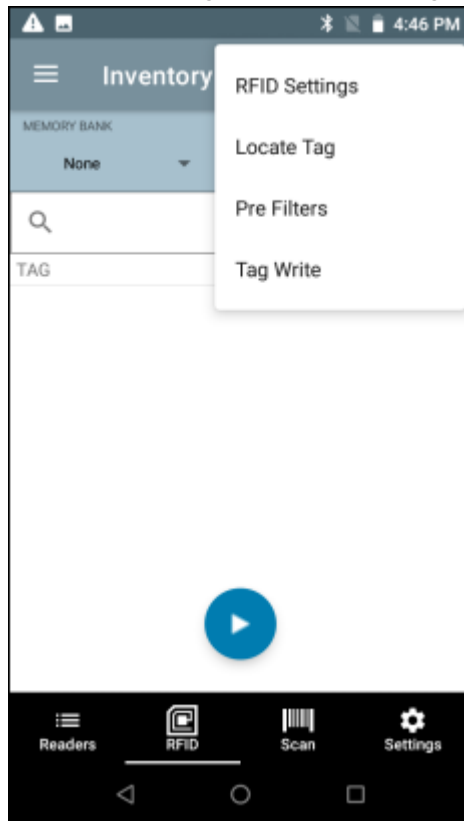

Progressing to another screen does not halt the operation. However, attempting to make changes or perform another operation while this operation is in process results in an error.



NOTE: Tags are fully convertible to ASCII format. ASCII mode may be enabled by selecting **Settings > Application Settings > ASCII Mode**.

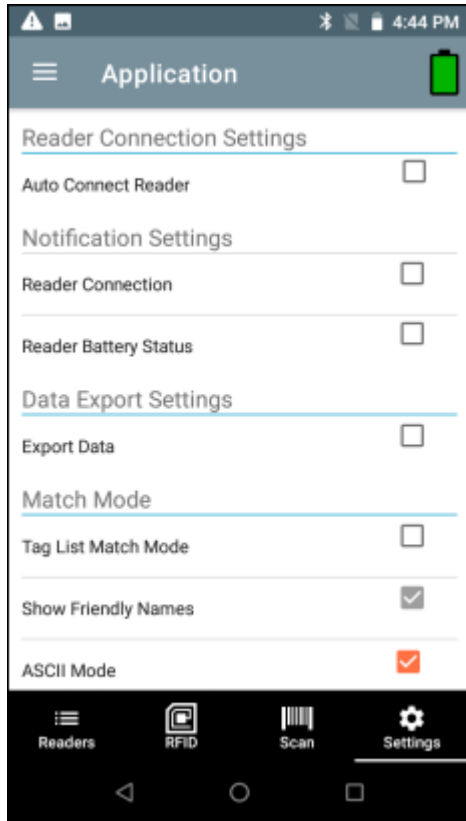

See Also

[Rapid Read](#)

Inventory Screen Features

The following table provides information on various metrics that can be captured using the Inventory feature.

Table 11 Inventory Screen Features

Item	Description
Tags	<p>Tap Memory Bank to select one of the following memory bank options from the drop-down menu:</p> <ul style="list-style-type: none"> • None - Defaults to EPC. • User - Allows reading user memory bank data when the tag is inventoried. • Reserved - Allows reading reserved memory bank data when the tag is inventoried. • TID - Allows reading TID memory bank data when the tag is inventoried. • EPC - Allows reading EPC memory bank data when the tag is inventoried. When the next inventory operation starts, the details from the selected memory bank displays. This menu is inactive if there is an ongoing operation on the connected reader. • Default Display - None.
Search	Tap the Search icon and enter a tag ID. Tags that match the entry display in the content area.
Power Management	Icon indicates if Dynamic Power is on. See Power Management. Tap the Power Management icon to open the Battery Status screen.
Content Area (select a tag)	Tapping a Tag ID highlights the tag. The highlighted Tag ID is populated on the Tag Location text area as well as the Tag Pattern area in the Access Control screen. Tap Start to start searching for the tag. See Tag List Match Mode Operation. From this screen, return to the Menu or go to the Home screen and select Locate Tag.

Table 11 Inventory Screen Features (Continued)

Item	Description
Content Area (select a tag)	<p>The tags displayed in this area are based on the option selected from RFID > RFID Advanced Settings > Tag Reporting. Tap the tag ID to expand details about the tag. Tap the tag ID again to collapse details.</p> <p>Example Default Tag Display: Tag ID Tag Count AD99 15404190725965400404</p> <p>Example Expanded Tag Display: Note: Expanded tag detail can only display when the inventory operation is stopped. Memory bank data is shown only when inventory is complete.</p> <p>Tag ID Tag Count AD99 15404190725965400404 EPC MEMORY 3000 RSSI -50 Phase 1800 USER 1122334455667788AABBCCDDEEFF 1122334455667788AABBCCDDEEFF 1122334455667788AABBCCDDEEFF</p> 

Table 11 Inventory Screen Features (Continued)

Item	Description

Tag List Match Mode Operation

When **Tag List Match Mode** is checked on the **Application Settings** screen, the application identifies tags from a given set of tags in csv tag list format (comma separated values file). Browse to choose the csv file. The contents of the csv file displays on the Inventory screen. By default, the application displays friendly names from csv files, if **Tag List Match Mode** is enabled. If you do not want to show friendly names, the setting can be disabled in Settings to show only EPC.

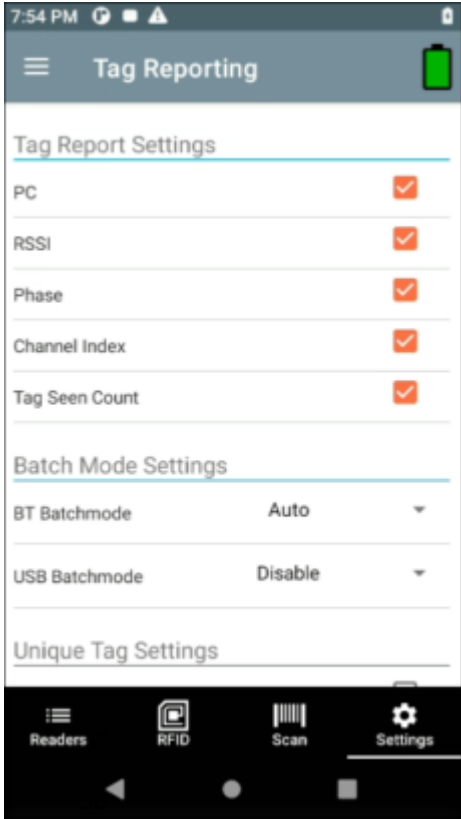
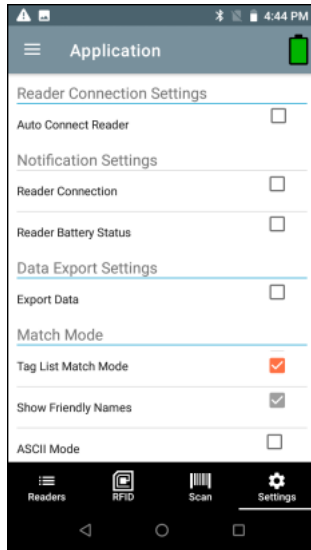

Before the inventory starts, the count is zero. The tag list can be sorted using the drop-down menu choices. Select an option to display the type of tags to show when the inventory starts.

- All
- Matching
- Missing
- Unknown

Figure 8 Tag List Match Mode Option Menu

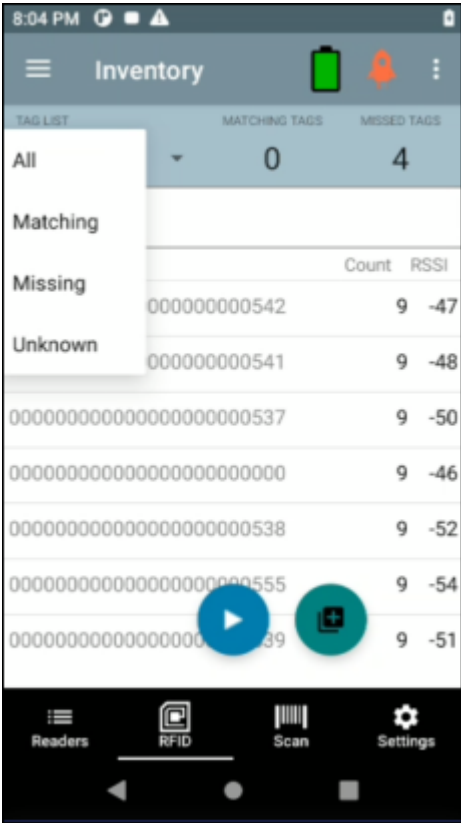
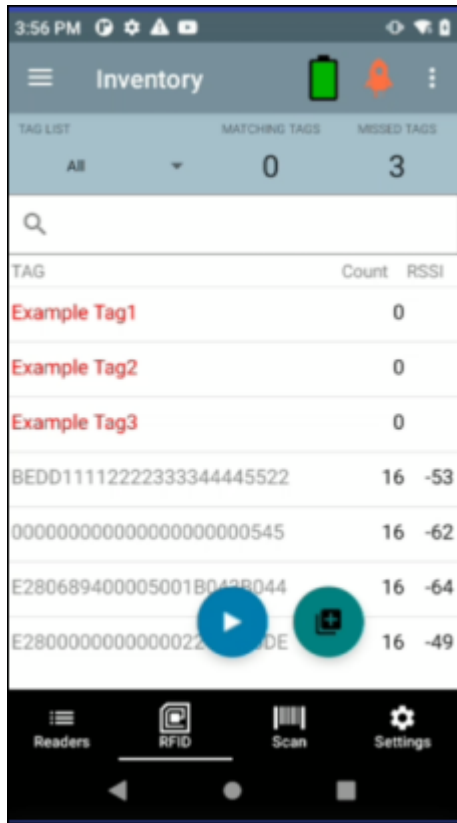

Figure 9 Tag List Match Mode Enabled with Friendly Names

If **Tag List Match Mode** is enabled, the text color changes accordingly:

- Matching = Green
- Missing/Expected = Red
- Unknown = Gray



NOTE: While running the inventory, you can re-import the csv file from the Inventory screen, by clicking **on the Re-import Tag list match mode csv file** icon.

See Also

[Sample 1 Inventory List: Tag List Enabled; Matching Tag Option Selected](#)

[Sample 2 Inventory List: Tag List Enabled; Missed Tag Option Selected](#)

[Sample 3 Inventory List: Tag List Enabled; Unknown Tag Option Selected](#)

[Sample 4 Inventory List: Tag List Enabled; All Tag Option Selected](#)

Tag List Color Mode

First, the Brand ID tag will be identified and the tag ID text color changes accordingly. Second, the non-Brand ID tag will be identified and the tag ID text color changes accordingly. Last, if Match Mode = Enable, then the text color changes accordingly to Match, Expected, or Unknown.

Brand ID Tag

- Blue: ASCII = Enable or ASCII = Disable, Tag List Match Mode = Disable.

Normal Tag (Brand ID = Disable)

Read both Brand ID and Non-Brand ID tags

- Black: ASCII = Enable or ASCII = Disable, Tag List Match Mode = Disable

Tag List Match Mode = Enable

- Green: Match read tag ID
- Red: Expected to read tag ID
- Gray: Unknown tag ID

Sample Contents of Taglist.csv File

The csv file should contain only alphanumeric characters in the tag column. If there are any special characters, the row is discarded.

The Taglist.csv file must be located inside the rfid folder which must be manually created at the Android device root directory.



NOTE: The folder name must be all lower case (for example, rfid and not RFID).

INVENTORY SUMMARY		
A	B	C
1	INVENTORY SUMMARY	
2	MATCH COUNT:	36
3	MISS COUNT:	36
4	UNKNOWN COUNT:	36
5	READ TIME:	0:00:11
6		
7	TAG ID	COUNT
8	30304035A880C80000123658	0 null
9	3035200EDC27074000123663	13 MATCH
10	8DF000000000000000081291D	0 MISS
11	30304035A880C80000123644	18 MATCH
12	30304035A880C8000012365C	82 MATCH
13	30304035A880C80000123654	0 null
14	30304035A880C80000123710	7 MATCH
15	30304035A880C80000123645	1 MATCH
16	30304035A880C80000123656	0 null
17	303425485C27074000123662	476 MATCH
18	30304035A880C8000012364D	0 MISS
19	30304035A880C80000123650	0 MISS
20	8DF00000000000000007CCCC7	0 MISS
21	30304035A880C80000123705	0 MISS
22	30304035A880C80000123737	3 MATCH
23	30304035A880C8000012370F	28 MATCH
24	30304035A880C8000012371D	27 MATCH
25	30304035A880C80000123721	8 MATCH
26	30304035A880C80000123736	0 null
27	AD99160042DB2190540000C6	0 MISS
28	8DF0000000000000000812998	0 MISS
29	30304035A880C8000012364C	0 MISS
30	30304035A880C80000123652	0 null
31	30304035A880C80000123664	532 MATCH
32	30304035A880C8000012364E	0 MISS
33	30304035A880C8000012364A	0 MISS
34	30304035A880C80000123657	0 null
35	30304035A880C80000123709	0 MISS

Sample 1 Inventory List: Tag List Enabled; Matching Tag Option Selected

When inventory starts, the application only displays the tag reads that match the tags in the taglist.csv file. Matching tags display in green. Select any tag read to show the matching tag details in the csv file.

Sample 2 Inventory List: Tag List Enabled, Missed Tag Option Selected

When inventory starts, the application only displays the tag reads that are missed and included in the taglist.csv file. Missed tags display in red. Select any tag to show the missed tag details in the csv file.

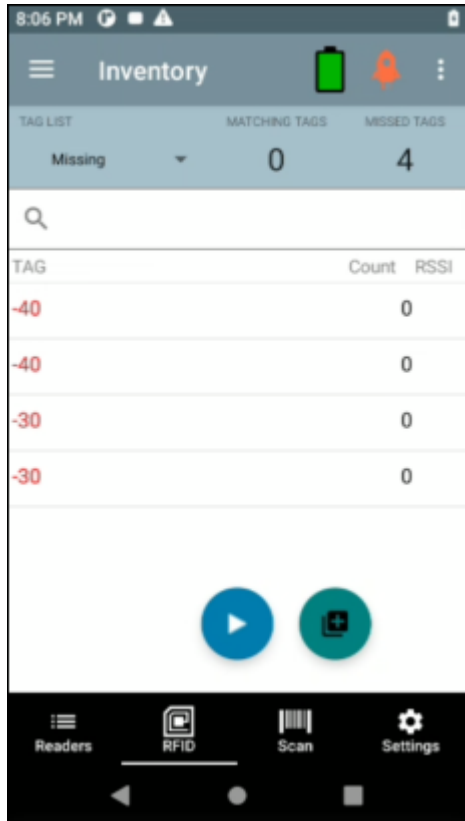

Sample 3 Inventory List: Tag List Enabled, Unknown Tag Option Selected

When inventory starts, the application only displays tags that were read but not included in the taglist.csv file, Unknown tags display in gray. Select any tag to show the unknown tag details.

Sample 4 Inventory List: Tag List Enabled, All Tag Option Selected

When inventory starts, the application displays the tags for all the options:

- Tag reads that match the tags in the taglist.csv file. Matching tags display in green. Select any tag read to show the matching tag details in the csv file.
- Tag reads that are missed and included in the taglist.csv file. Missed tags display in red. Select any tag to show the missed tag details in the csv file.
- Tags that were read but not included in the taglist.csv file. Unknown tags display in gray. Select any tag to show the unknown tag details.

Sample 5 Tag List Matching Selected; Show Friendly Names

When inventory starts, the application displays the tags for selected options from All, Matching, Missing, or Unknown. Application shows friendly names (i.e. Tag details instead of EPC) on screen.

Sample 6 Exporting Data - Tag List Matching Selected

The application settings screen has the option to Export Data. If the option is checked, data is exported when the inventory stops. The tag content area is exportable to a file. For example, when Matching is

selected from the menu to display only matching tags in the tag content area, the matching data can be exported to a file. The exported csv file includes the matching, missing, and unknown tag count.

Unique Tag Reporting

When Report Unique Tags is enabled on the Tag Reporting screen, the reader reports only unique tags based on the options below.

- When the Matching option is selected (See Sample 1 Inventory List: Tag List Enabled; Matching Tag Option Selected) the tag count cannot be greater than one because the unique tags are only reported one time.
- When the Matching option is not selected, the list displays unique and total reads. The tag count cannot be greater than one because the unique tags are only reported one time.

To export data, from the bottom navigation bar, tap **Settings** > **Application** and enable **Export Data** or tap **☰** > **Settings** > **Application** and enable **Export Data**.

Exported files are saved under /sdcard/inventory/RFID_2022-01-24_15-59-38.131.csv

Each exported file is named using the date and timestamp.

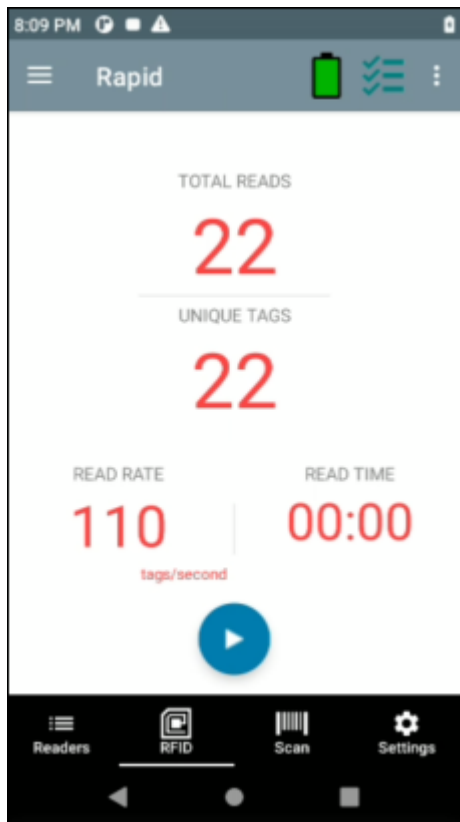

NXP BrandID Check

When **Check BrandID** is enabled on the Tag Reporting screen, the reader reports only tags based on the brand options below.

- Brand ID

- EPC Length

After enabling the **Check BrandID** settings, you can start the inventory. If the tag has a matching brand ID, the inventory list displays tag data in blue.

Locate Tag

Use Locate Tag to locate a single tag or multiple tags (Multi Tag). From the Inventory screen, tap  and select **Locate Tag**.

Locate a Single Tag

To locate a single tag:

1. Tap Locate Tag from the Home or Menu screen.
2. Enter the Tag ID in the text area or select a tag from the Inventory screen to pre-populate the Tag ID to search.
3. Tap Start to start the locate tag operation.
4. Tap Stop to stop the locate tag operation.



NOTE: The scan trigger on the device can also start and stop the locate tag operation. Press the trigger to start, continue to hold and release to stop.

The Locate Tag screen displays a color bar graph showing the proximity % (relative distance) of the tag. The % gives the relative distance, for example, from 0% to 100% where the tag is very far or very close respectively

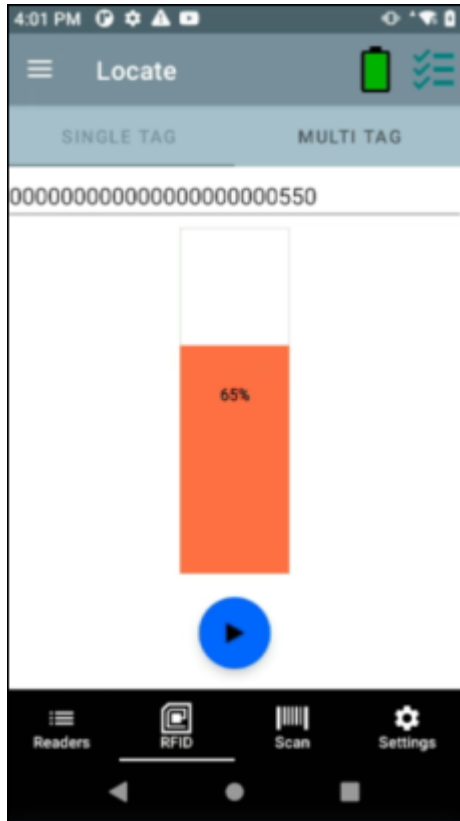

Progressing to another screen does not halt the operation, until Stop is selected. However, attempting to make changes or perform another operation while the locate tag operation is in process results in an error.

Locate Multiple Tags (Multi Tag)

Locate multiple tags by importing a csv file.



NOTE: Multi Tag Locate supports ASCII mode. Enable ASCII mode from **Settings > Application > Global Settings > Enable ASCII Mode**.

To locate and track multiple tags:

1. Tap Locate Tag from the Home or Menu screen.
2. Select the **Import csv file** on the Multi Tag panel.
The csv file holds the EPC ID and RSSI value. The default RSSI for the EPC will be -33.
3. Select the file containing the specific tag information from the file manager to bring the file into the application.
4. Tap the **Reset Data** icon to reset the tag count and RSSI proximity %.
5. Tap the **Add Tag ID** icon to add the EPC value of interest to the dynamic list of EPC's. It can only add the value which is present in the imported csv file.

- 6. Tap the **Remove Tag ID** icon to remove the EPC value of non-interest from the dynamic list of EPC's. It can only remove the value which is present in the csv file.



NOTE: Once you re-access the MultiTag Locate screen, the entire tag list from the csv file displays, if values were deleted dynamically.

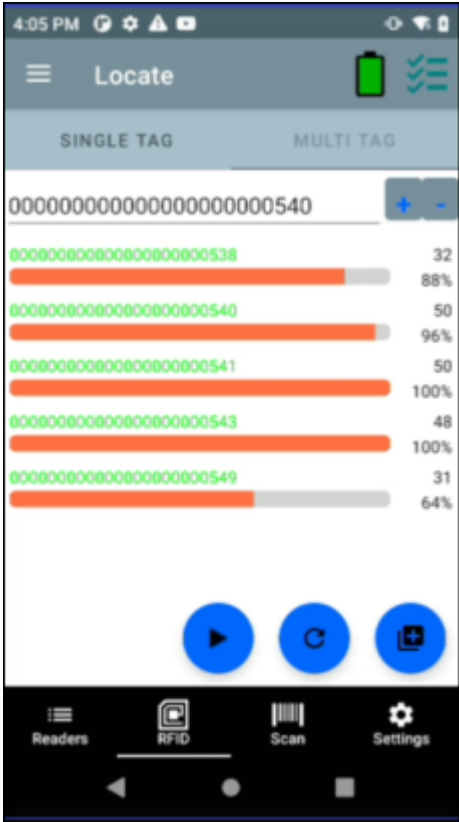

Pre Filters

- 1. From the Inventory screen, tap  and select **Pre Filters**.

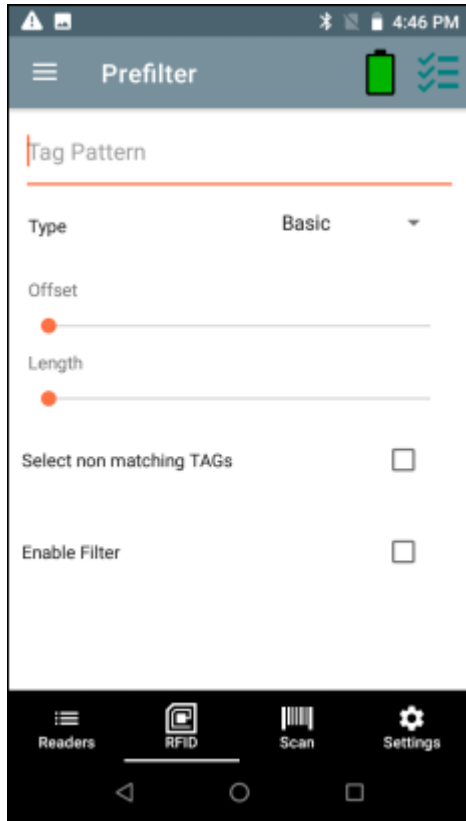

2. Select Basic or Advanced.
3. Complete the following:
 - a) Memory Bank - EPC, TID and USER.
 - b) Offset (words) - Offset in the memory bank is specified in words.
 - c) Length (octets) - pattern length.
 - d) Select non matching TAGs - Inventory shows tags which are not matching with Tag pattern entered.
 - e) Action:
 - INV A NOT INV B or ASRT_SL_NOT_DSRT_SL
 - INV A or ASRT SL
 - NOT INV B or NOT DSRT SL
 - INV A2BB2A NOT INV A or NEG SL NOT ASRT SL
 - INV B NOT INV A or DSRT SL NOT ASRT SL
 - INV B or DSRT SL
 - NOT INV A or NOT ASRT SL
 - NOT INV A2BB2A or NOT NEG SL
 - f) Target - SESSION S0, SESSION S1, SESSION S2, SESSION S3 & SL FLAG.



NOTE: Up to two pre-filters can be enabled.

Tag Write

1. From the Inventory screen, tap  and select **Tag Write**.
2. Select **Read/Write tags, Lock, Kill**.

Read/Write

The Tag Pattern area is automatically filled in when a tag is selected in the Inventory screen. The Read/Write access operation is simplified with offset and length fields are hidden. The user can tap the more/advanced options icon to see offset and length fields. Tap the icon again to hide the advanced options.

Memory Bank options now have extended menu options to choose directly interested area of memory bank. This avoids typing of offset and length etc.



NOTE: SDK 2.0.49 enabled with the Write + 1 retry feature, improves the efficiency during the Tag Write operation.

Read/Write options are:

- Tag ID and Password values are in hex. Tag ID is edited.
- Memory Bank options - EPC, TID, USER, PC and CRC, Access Password, Kill Password.
- Offset and Length values are in 16-bit words. This is only available after tapping the Advanced Options icon. To toggle visibility, tap Advanced Options again.
- Access operation screen maintains edited tag ID.



NOTE: The user can read/write to/from tags in ASCII mode.

Figure 10 Read/Write Basic

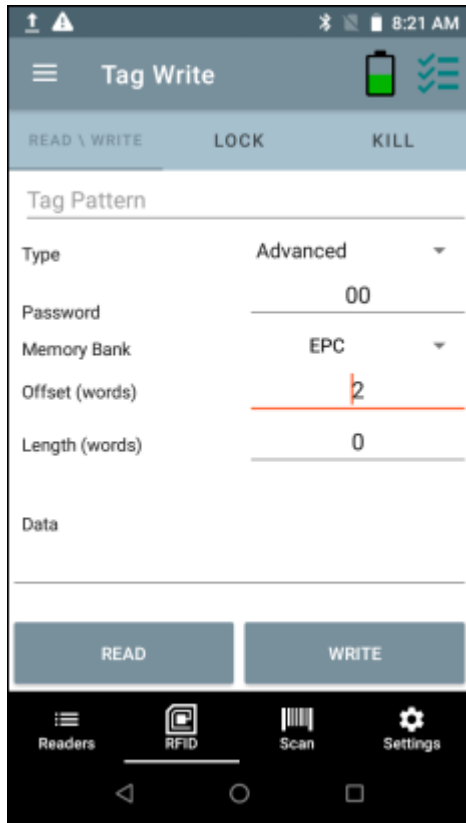

Figure 11 Read/Write Advanced

Lock



NOTE: U9 NXP tags are not supported.

Lock privilege options are as follows:

- Read and Write
- Permanent Lock
- Permanent Unlock
- Unlock



Kill

Permanently renders the tag unusable. A Kill Password must be provided.



Settings

To access Settings, tap **Settings** from the bottom navigation bar or tap  > **Settings**. Settings are divided into four types:

- **General** - allows you to configure settings on the device.
- **RFID** - allows you to configure specific reader and antenna settings.
- **Application** - allows you to make changes to the 123RFID Mobile Application settings.
- **SCAN** - allows you to configure settings for the scanner.

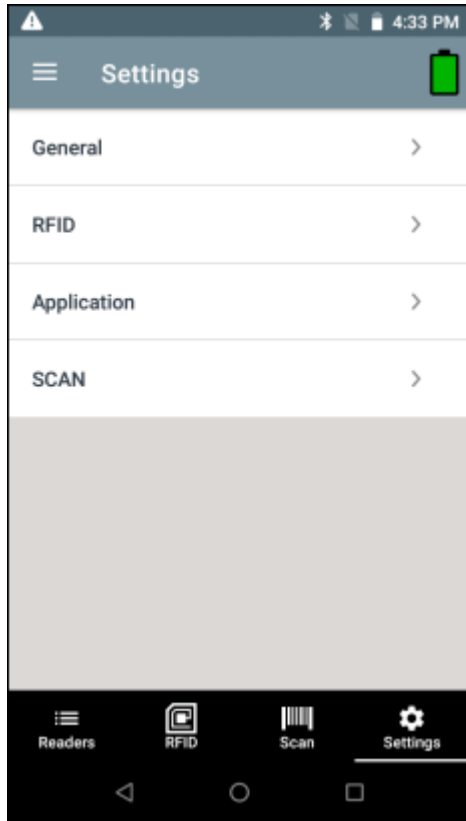

See Also

[General Settings](#)

[RFID Settings](#)

[Application Settings](#)

[Scan Settings](#)

General Settings

To access General Settings, from the bottom navigation bar, tap **Settings** > **General** or tap **☰** > **Settings** > **General**. The General Settings screen options include:

- **Firmware Update** - Update the firmware on the reader.
- **Factory Reset** - Reset file settings on the reader to factory defaults.
- **Enable Logging** - Enable the logging of tag reads.
- **Device Info** - View information such as friendly name, serial number, and RFID/scan settings.
- **Share File** - Share a file with a paired device.
- **Trigger Mapping** - Change the mapping for the upper and lower trigger and designate the Upper Trigger for RFID decode and the Lower Trigger for Host Scan or the Upper Trigger for Host Scan and the Lower Trigger for RFID decode.

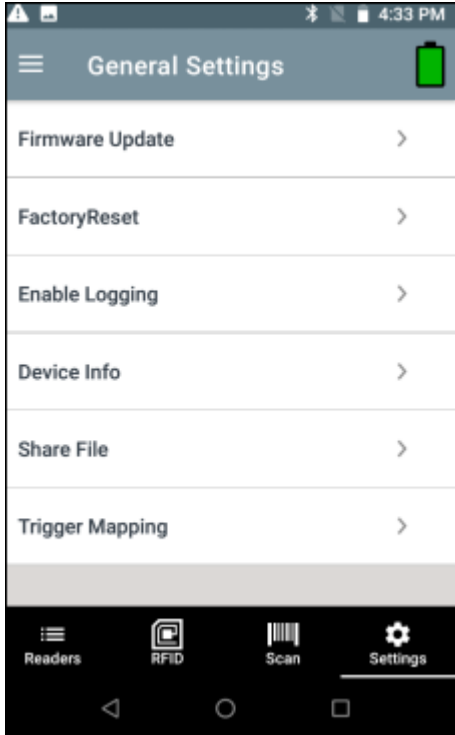

See Also

- [Firmware Update](#)
- [Factory Reset](#)
- [Enable Logging](#)
- [Device Info](#)
- [Share File](#)
- [Trigger Mapping](#)

Update the Device Firmware



NOTE: Available only on RFD40.

To update device firmware:

1. To access Firmware Update, from the bottom navigation bar, tap **Settings** > **General** > **Firmware Update** or tap **☰** > **Settings** > **General** > **Firmware Update**.

2. Select the firmware version to be loaded onto the device.

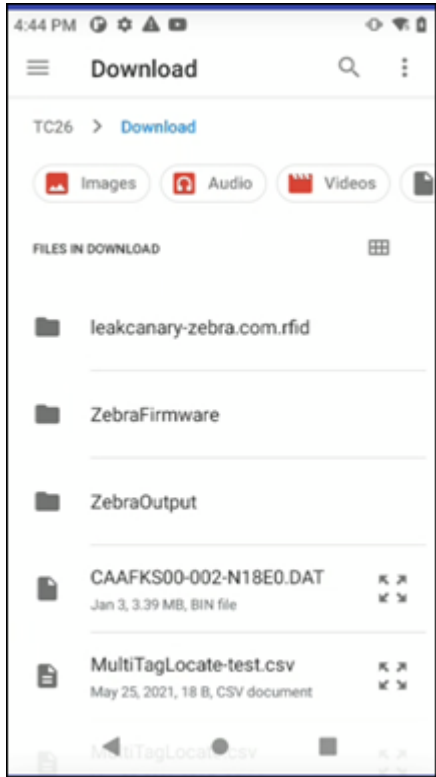

- a) Copy the correct .DAT file to /SDcard/download.
- b) Make sure the terminal is connected to the device.

3. Tap **Update Firmware**.



Factory Reset

Performing a factory reset will clear any saved settings and restart the reader. Region needs to be set again.

- 1. To reset to factory defaults, from the bottom navigation bar, tap **Settings > General > Factory Reset** or tap **≡ > Settings > General > Factory Reset**.

2. Select one of the following:

a) **FactoryReset** to perform a factory reset.

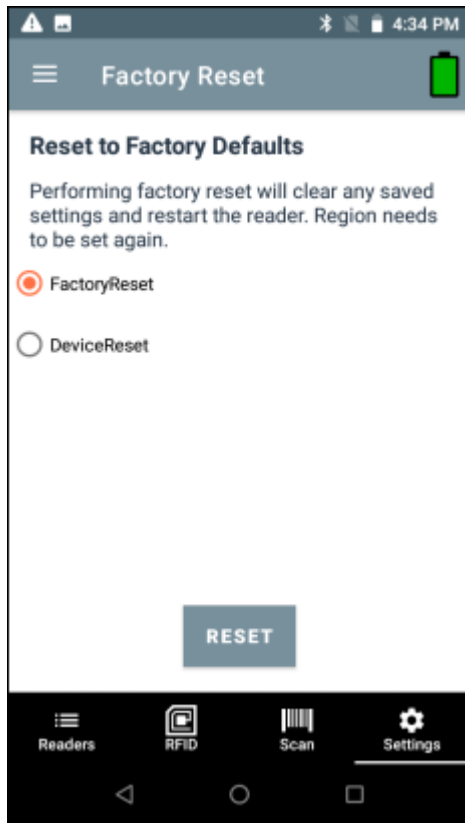

b) **DeviceReset** to perform a device reset, which reboots the RFDXX device.

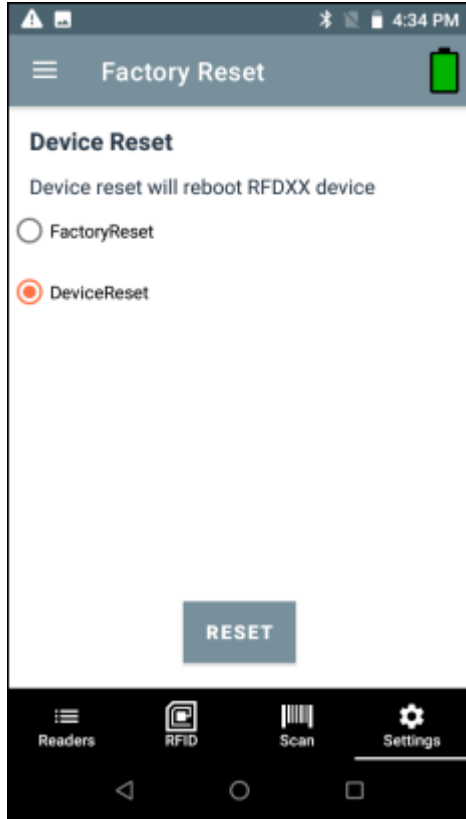

3. Tap **RESET**.

Enable Logging

1. To enable logging, from the bottom navigation bar, tap **Settings > General > Enable Logging** or tap **☰ > Settings > General > Enable Logging**. All the enabled logs are captured in logcat which can be retrieved through RxLogger for EMC devices.

2. Specify the following:

- Tap **Enable real time Logs** to toggle on or off.
- Tap **Enable NGE Error Logs** to select.
- Tap **Enable NGE Event Logs** to select.
- Tap **NGE packet Logs** to select.
- Tap **RETRIEVE LOGS FROM RAM** or **RETRIEVE LOGS FROM FLASH**.
- Tap **Enable Debug logs** to toggle on or off.

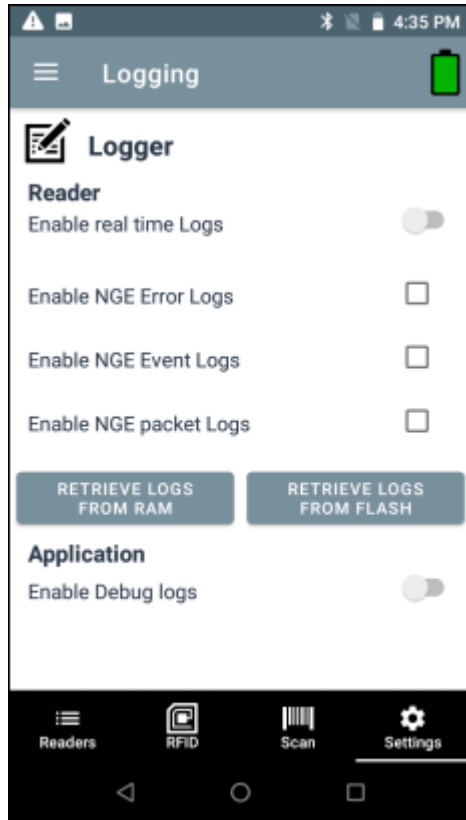

Device Info

To access Device Info, from the bottom navigation bar, tap **Settings > General > Device Info** or tap **☰ > Settings > General > Device Info**.

Device Info displays the following:

- Model Number
- Serial Number
- Firmware
- Manufacture Date
- Application Version
- SDK Version

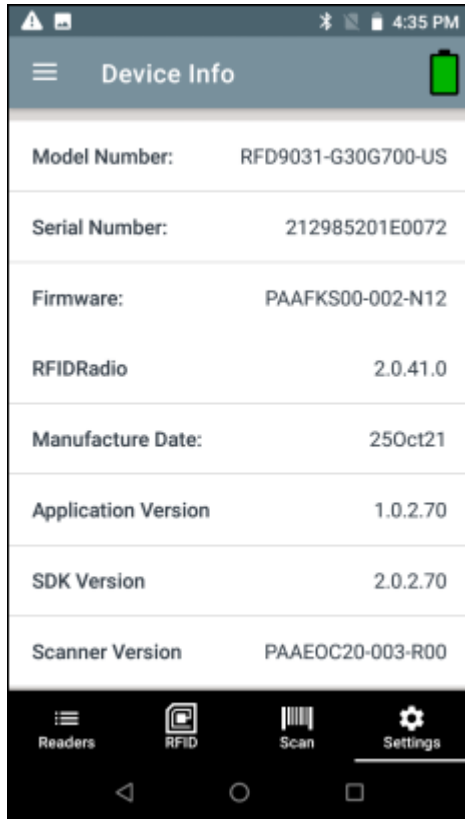

Share File

1. To share a file, from the bottom navigation bar, tap **Settings** > **General** > **Share File** or tap **☰** > **Settings** > **General** > **Share File**.

File Explorer opens.

2. Select a single file or multiple files.

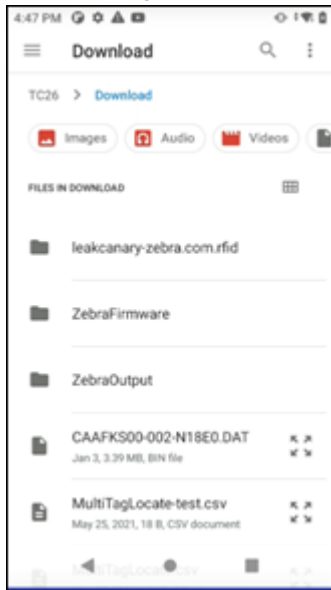

User has an option to share the file(s) to a nearby device via Bluetooth or any other file sharing supported app.

3. Select from the provided options.

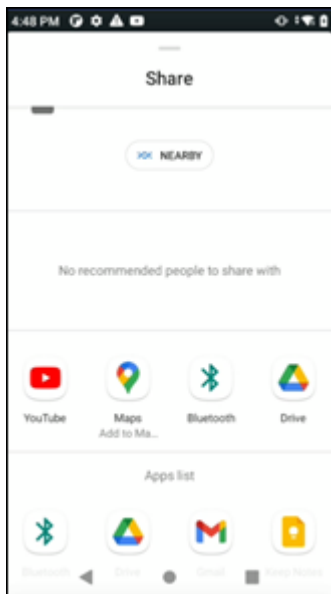

Trigger Remapping

To perform a Trigger-remapping operation using [RFID3 API](#), start by creating a new project in Android Studio. For additional information, refer to the [Android Studio tutorial](#). To learn more about preparing the basic environment to work with an RFID reader, refer to [Hello RFID](#) before following the steps in this section.



NOTE: The following remapping functionality in the RFID SDK is supported for Android 2.0 and later.

The RFID SDK allows users to configure the upper trigger and the lower trigger with the following options.

- RFID_SCAN
- SLED_SCAN
- TERMINAL_SCAN
- SCAN_NOTIFICATION
- NO_ACTION

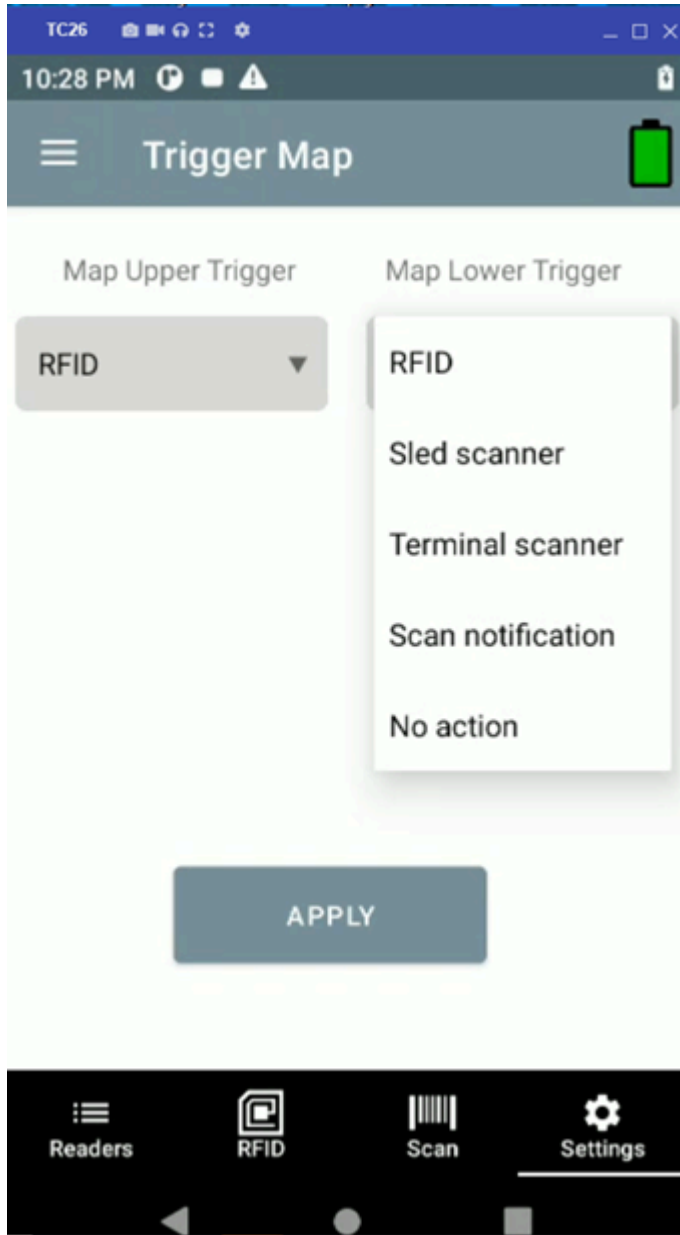



NOTE: Terminal scan refers to the scanner on the EMC terminal, not on the RFID sled. In this example, the RFID SDK or the application does not get involved. Terminal scan enables EMC terminal scan trigger. Each hardware trigger can be independently configured with the options listed above.

The user receives a scan notification through a trigger `HANDHELD_TRIGGER_EVENT` notification. The trigger event has an extra field for trigger type to indicate whether it is an RFID trigger press or a scan trigger press.

Trigger Type: 0	RFID Trigger
Trigger Type: 1	Scan Trigger

RFID_SCAN	Configures the hardware trigger to initiate RFID tag reads.
SLED_SCAN	For Premium+ devices to configure the hardware trigger to simulate a barcode scan using the imager inside the RFID sled.
SCAN_NOTIFICATION	Posts the scan trigger notification to the user, but does not initiate barcode decode or RFID tag reads.
TERMINAL_SCAN	Configures the hardware trigger to initiate barcode scanning on the terminal. This is applicable only for mobile computers connected to the RFID sled through the eConnex connector.
NO_ACTION	Mutes the hardware trigger functionality.

RFID Settings

To access RFID Settings, from the bottom navigation bar, tap **Settings > RFID** or tap  > **Settings > RFID** or from the Rapid Read or Inventory screens, tap  > **RFID Settings**. RFID Settings options include:

- Profiles - Displays Fastest Read, Cycle Count, Dense Readers, Optimal Battery, Balanced Performance, User Defined and Reader Defined profiles.
- Advanced Reader Settings - Antenna, Singulation Control, Start/Stop Triggers, Tag Reporting, Power Management and Save Configuration.
- Regulatory - Allows selection of region and available channels.
- Beeper - Provides the option to change the volume of both the host and sled device.
- LED - Enables/Disables Terminal/Host tag read LED for inventory indications.



NOTE: Available only on RFD8500 and MC33.

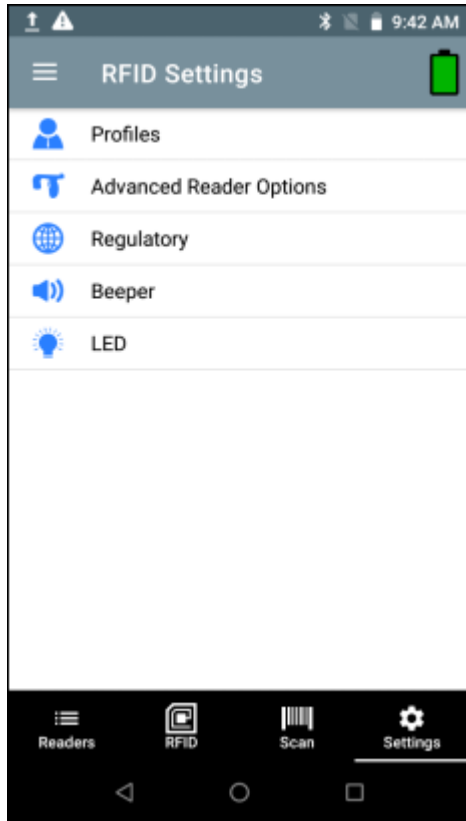

Profiles

To display the list of profiles, from the bottom navigation bar, tap **Settings > RFID > Profiles**.

- The currently selected profile is highlighted in orange.
- Tap profile item to expand the profile and view applicable configurations.
- Profiles can be selected or disabled by using the slider switch to the right of the profile name.



NOTE: If Power Level, Link Profile, Session, or Dynamic Power are modified from each respective screen, then the currently selected profile changes to User Defined profile and profile item values are modified with same values.

Profile setting options include:

- Fastest Read - Read as many tags as fast as possible.
- Cycle Count - Read as many unique tags as possible.
- Dense Readers - Use when there are multiple readers within close proximity.
- Optimal Battery - Provides optimal battery life.
- Balanced Performance - Maintains balance between performance and battery life.
- User Defined - Custom profile used for custom requirements.
- Reader Defined - Maintains reader configurations.

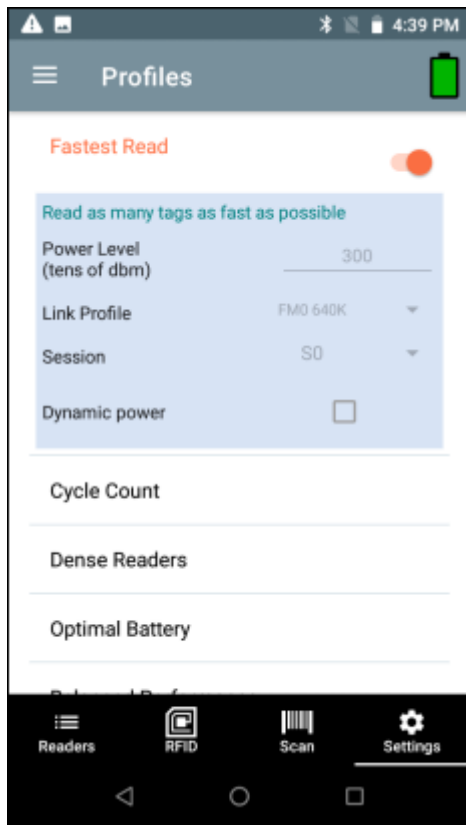
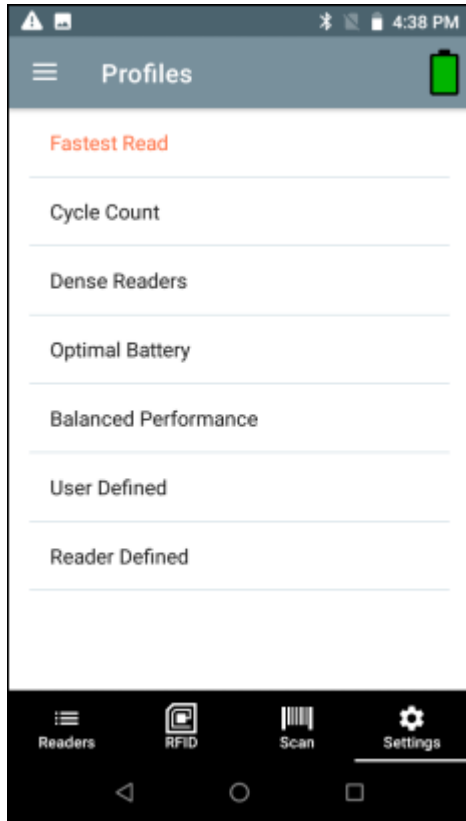

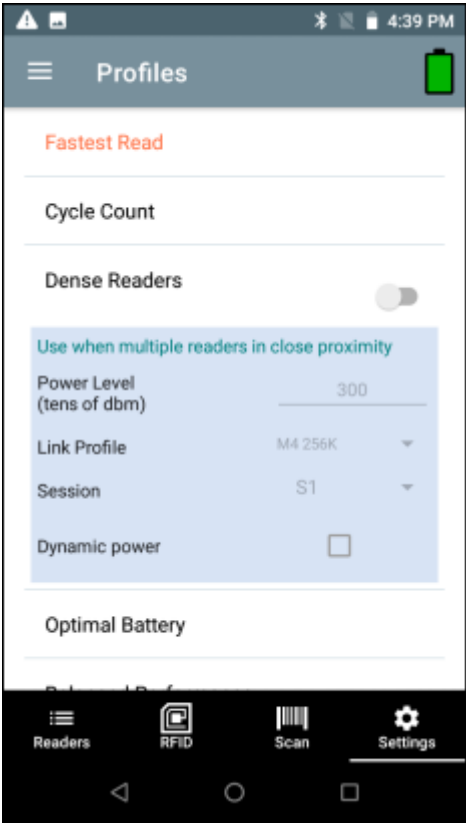
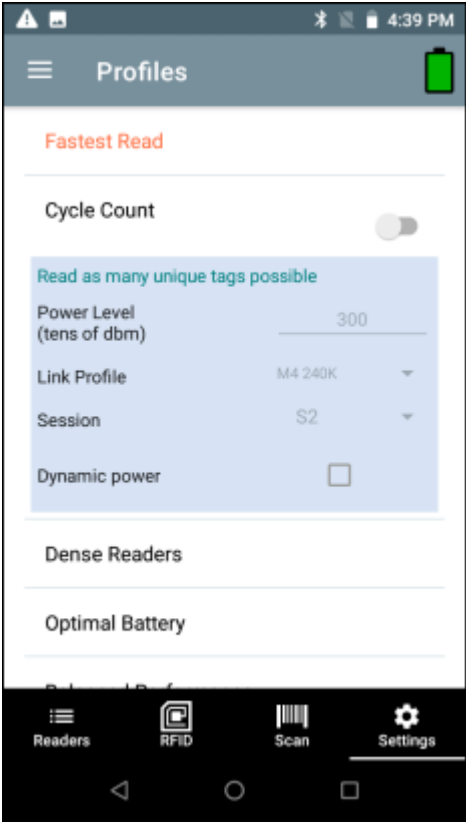

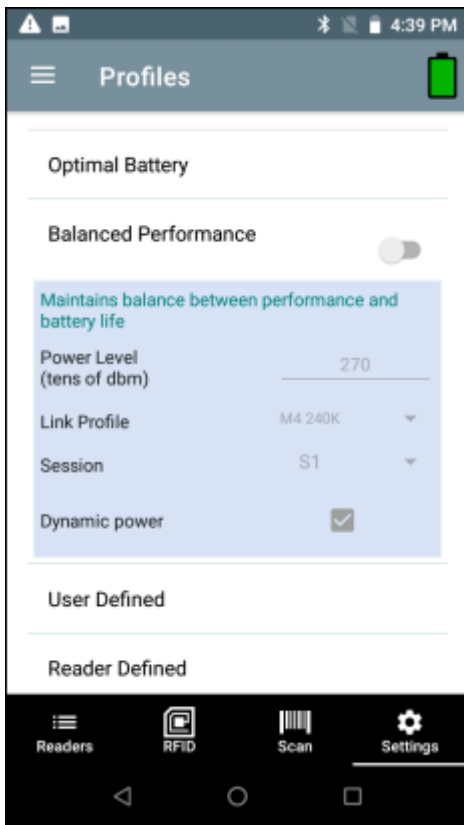
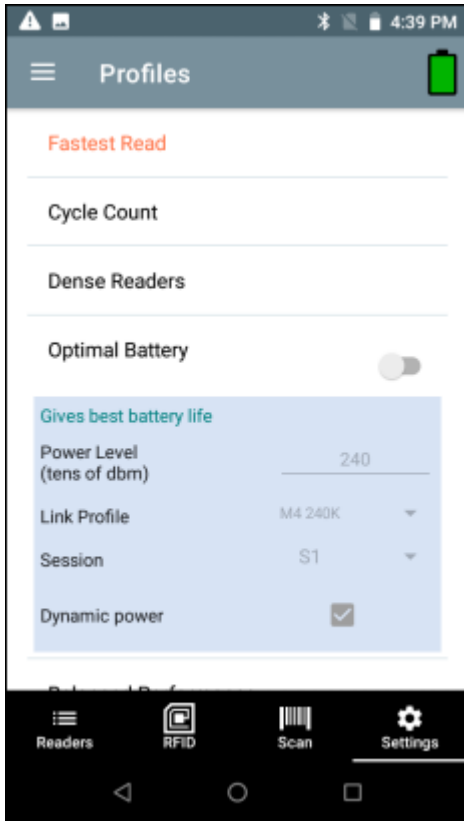

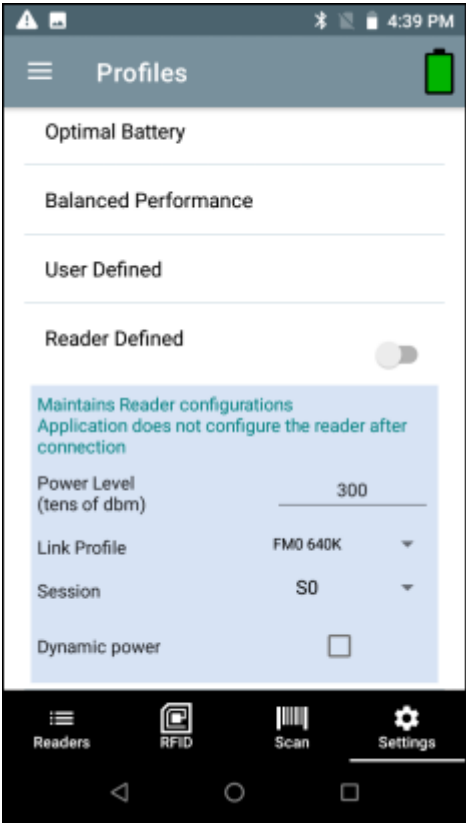
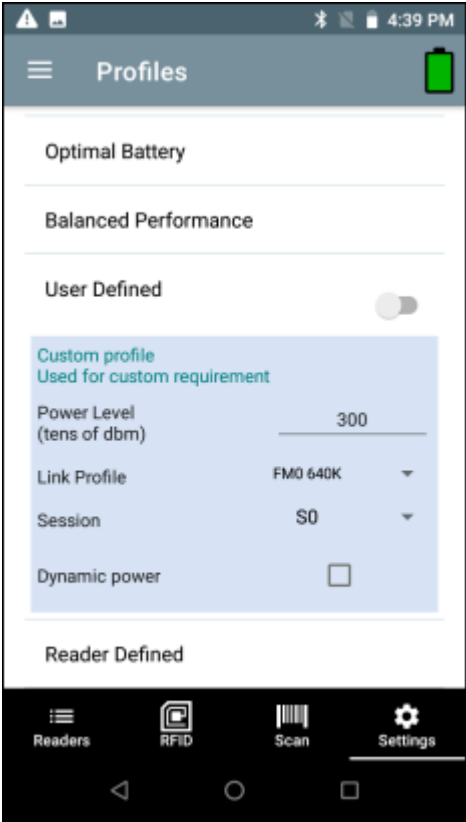

Advanced Reader Options

To set advanced reader options, from the bottom navigation bar, tap **Settings** > **RFID** > **Advanced Reader Options**. Advanced Reader Options include:

- Antenna
- Singulation Control
- Start/Stop Triggers
- Tag Reporting
- Save Configuration
- Power Management

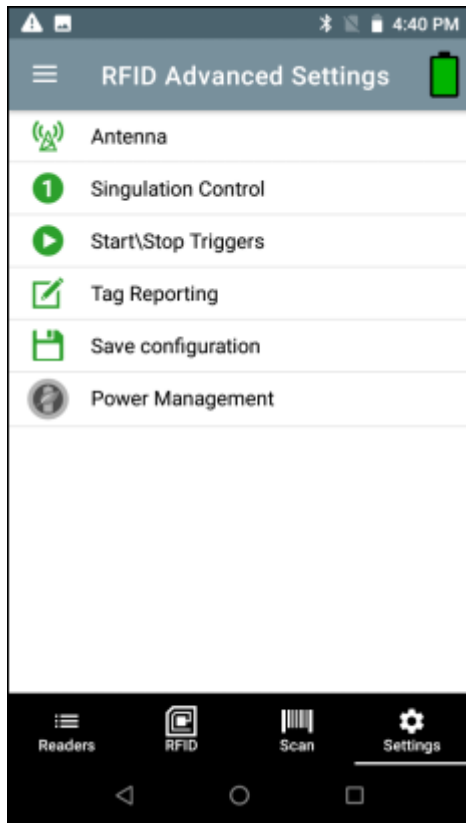

See Also

[Antenna](#)

[Singulation Control](#)

[Start/Stop Triggers](#)

[Tag Reporting](#)

[Save Configuration](#)

[Power Management](#)

Antenna

To access the Antenna screen, from the bottom navigation bar, tap **Settings > RFID > Advanced Reader Options > Antenna**. The Antenna screen displays the following:

- Power Level - Displays the current selection and a text box for available power levels (as reported by the device). The default setting is 27.0 dBm (shown as 270; the value displayed is in units of tens of dBm). Japan units are set to a different default power level depending on the SKU type. The minimum power level when DPO is enabled is 3.1 dBm. When DPO is disabled, the minimum power level is 0 dBm.
- Link Profile - Displays the current selection and includes a drop-down list of available link profiles (reported by the device). Link Profile display format is as follows: Return link bit data rate in bis per second (e.g., 60000 -> 60 Kbs); Miller Value (e.g., MV_4 -> Miller 4); thus profile name M4 240K (240K becomes BLF) modulation type (PR ASK is the only one supported).
- PIE value has no units and is either 1500 and 2000 minimum.
- Tari applicable Tari value in thousands of micro seconds (e.g., 6250 -> 6.25 microseconds).



NOTE: By default, the fastest read profile is selected and configures the reader for the maximum power level allowed based on the read profile. However, the dBm can be limited due to the regulatory requirements of the specified region in which the sled is being used.

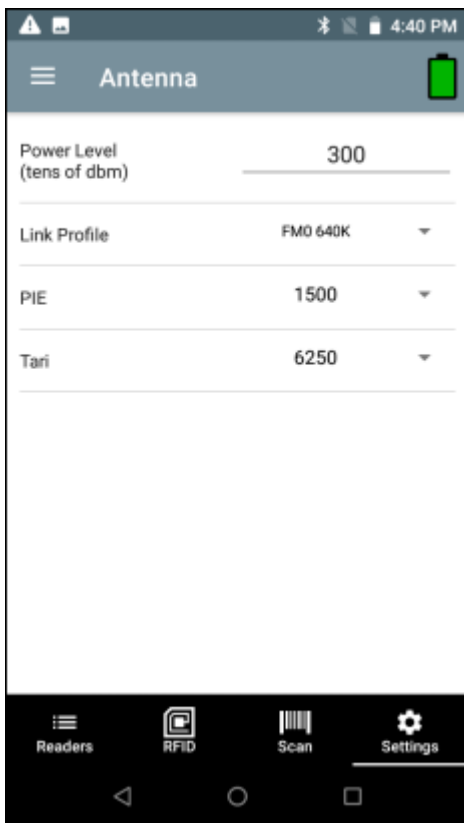

NOTE: The Power Level and Link Profile are blank when there is no connection to the reader.

Singulation Control

To access Singulation Control, from the bottom navigation bar, tap **Settings** > **RFID** > **Advanced Reader Options** > **Singulation Control**. View or configure the singulation control settings for each antenna.

- Session - The drop-down list includes the available session options (S0, S1, S2, S3).
- Tag Population - A numeric value of the estimated number of tags in the Field of View (FOV). Values shown are 30, 100, 200, 300, 400, 500, 600.
- Inventory State - State A, State B, AB Flip.
- SL flag - ALL, DEASSERTED, ASSERTED.

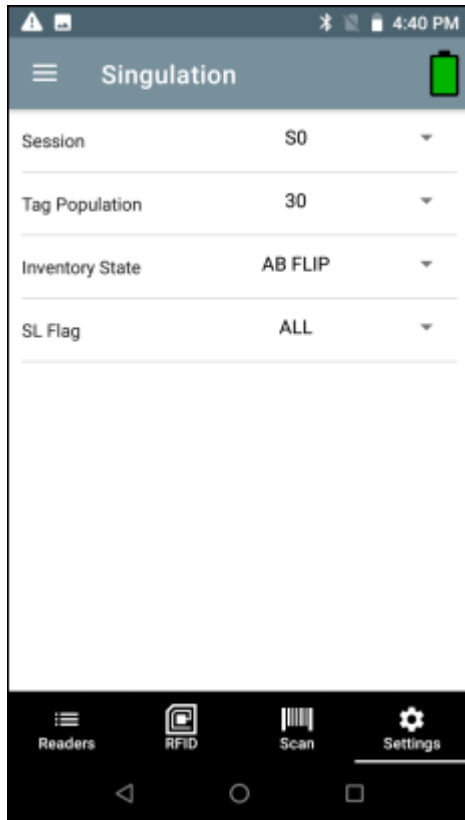

Start and Stop Triggers

To access the Start and Stop Triggers screen, from the bottom navigation bar, tap **Settings** > **RFID** > **Advanced Reader Options** > **Start/Stop Triggers**.

The Start Trigger Periodic displays the Period input box (in milliseconds).

The Stop Trigger Duration, Tag Observation and N attempts display numeric value input boxes.

All time entries are in milliseconds. All the required details for saving triggers to the reader must be entered or the application does not save the trigger settings to the reader.

Required input for Start/Stop Trigger settings are as follows:

- Start Trigger
 - Immediate (default)
 - Handheld - Select either the Trigger Pressed or Trigger Released check box.
 - Periodic - Enter the period of time in milliseconds.
- Stop Trigger
 - Immediate (default)
 - Hand-held - Select either the Trigger Pressed or Trigger Released check box along with Timeout in milliseconds.
 - Duration - Enter duration in milliseconds.
 - Tag Observation - Enter the tag count along with timeout in milliseconds.
 - N Attempts - Enter the number of attempts along with timeout in milliseconds.



If the start trigger type is set to Hand-held trigger (pressed or released), the application sets the repeat for the operation to ensure the use case if repeated operations can be demonstrated.

If any trigger is defined as Hand-held, the application does not act on immediate trigger type for a Hand-held trigger action.

Tag Reporting

To access Tag Reporting, from the bottom navigation bar, tap **Settings > RFID > Advanced Reader Options > Tag Reporting**.

Tag Reporting screen options include:

- **Channel Index** - Select to indicate whether or not the Regulatory Channel Index is reported as part of the Tag Data.
- **Tag Seen Count** - Select to indicate whether or not the Tag Seen Count is reported as part of the Tag Data.
- **Report Unique Tags** - When this option is enabled, the reader reports only unique tag reads. The Unique Tag reporting feature can be enabled when using Tag List Match mode.
- **Check BrandID** - Check box to enable the Brand ID option.
- **Brand ID** - Perform NXP BrandID check (supported only on NXP U-Code 8 and above tags that supports this functionality). Brand ID check can be initiated by enabling BrandID. Reader performs an inventory operation with additional verification on whether or not the tag inventoried matches the BrandID and reports.
- **EPC Length** - The EPC length provided will consider the length of EPC data to be matched for Brand ID tags from offset 0.
- **PC** - Select to allow reporting the PC as part of the Tag Data.
- **RSSI** - Selection indicates whether or not the RSSI (Received Signal Strength Indication) is reported as part of the Tag Data.
- **Phase** - Select to indicate whether or not the Phase is reported as part of the Tag Data.

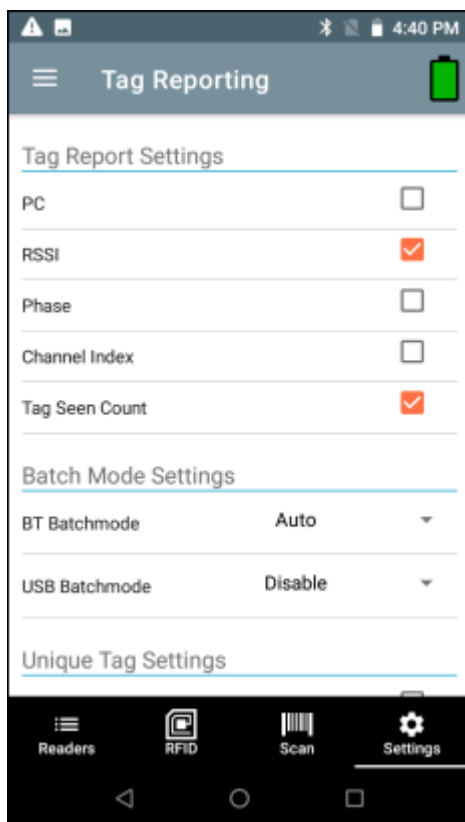

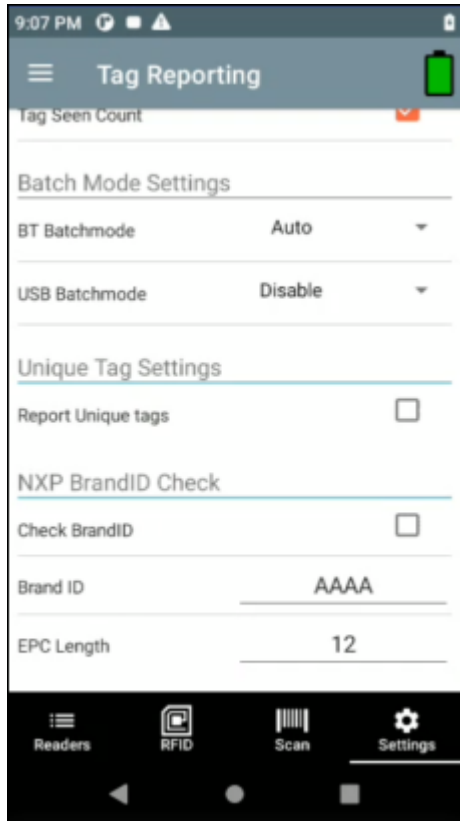

Save Configuration

To access Save Configuration, from the bottom navigation bar, tap **Settings > RFID > Advanced Reader Options > Save Configuration**. This screen is used to save the settings and displays the current settings on the device.

The settings are saved on the device until a reset to factory defaults is performed on the unit (see Settings).

The Tag Pattern form field is automatically populated with tag data when a tag is selected from the Inventory Screen.

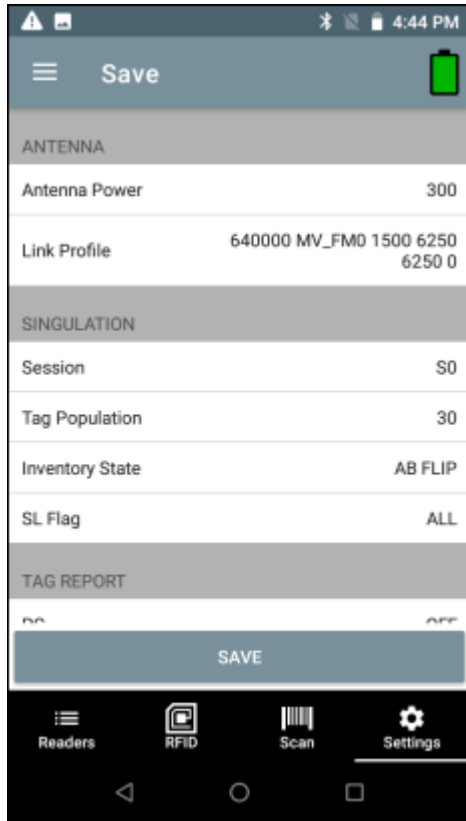

Power Management

To access Power Management, from the bottom navigation bar, tap **Settings** > **RFID** > **Advanced Reader Options** > **Power Management**. This screen provides an option to enable Dynamic Power Optimization (DPO) in the reader. Enabling DPO enhances battery life during inventory operations.

If Dynamic Power is On, a green battery icon appears in the title bar of the application. Tapping on this opens the Battery Status screen.

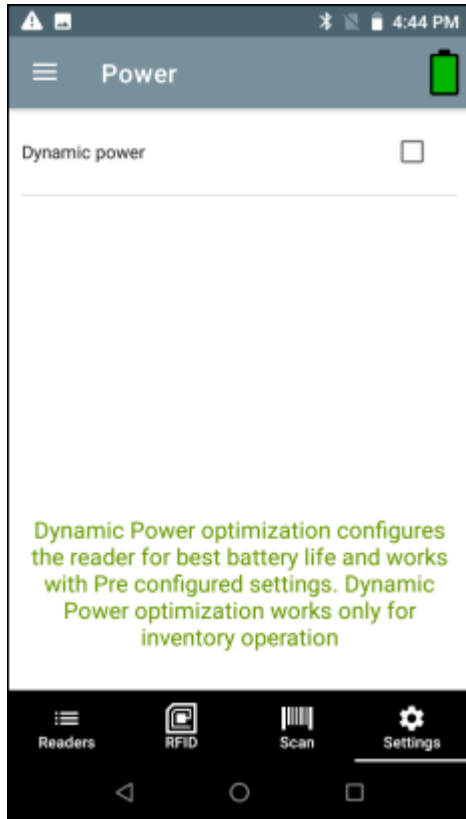

Regulatory

1. To set regulatory options, from the bottom navigation bar, tap **Settings** > **RFID** > **Regulatory**.



WARNING: Select only the country in which you are using the reader.

2. Select the region from the drop-down list.

3. Select from the available channels.

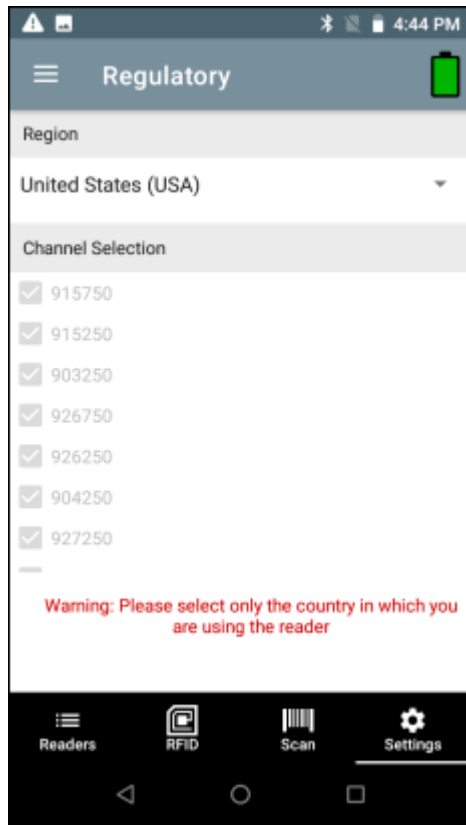

Beeper

1. To set beeper options, from the bottom navigation bar, tap **Settings > RFID > Beeper**.
2. Enable/disable the beeper on the sled.
3. Enable/disable the beeper on the host.

4. Select the volume:

- High
- Medium
- Low

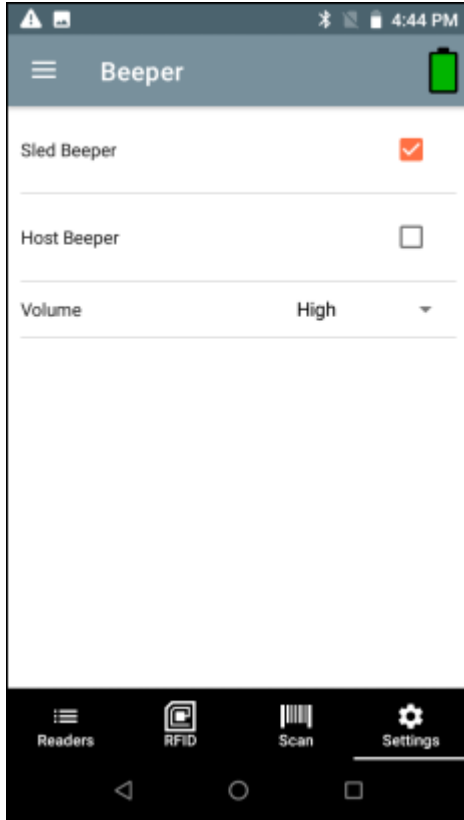

LED

1. To set LED options, from the bottom navigation bar, tap **Settings** > **RFID** > **LED**.

2. Enable/disable the LED on the host.

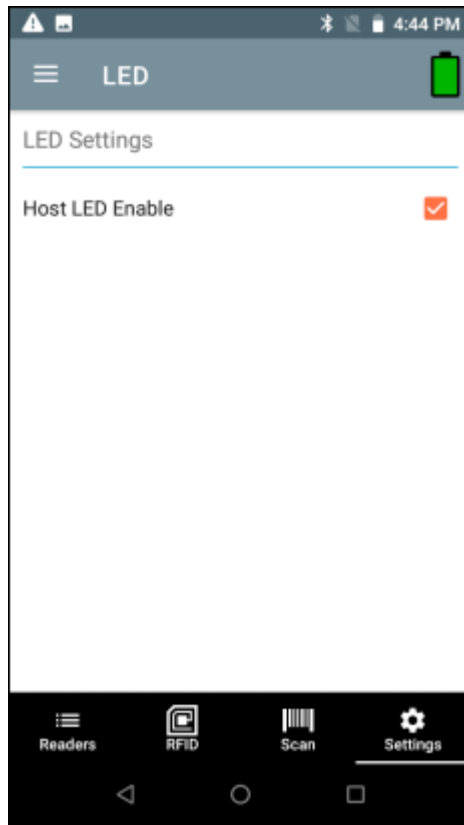

Application Settings

To access Application Settings, from the bottom navigation bar, tap **Settings > Application** or tap **☰ > Settings > Application**.

The Application Settings screen includes:

- Auto Reconnect Reader - When checked, the device connects to the RFID service which manages the connection to the reader.
- Reader Connection Notification - When checked, the application notifies the user when the reader is connected or disconnected.
- Reader Battery Status Notification - When checked, the application notifies the user when the battery has reached specific critical states.
- Export Data - When checked, the application writes the inventoried RFID data to a file when the inventory operation stops. On Android platforms the file is saved in a fixed directory. Check the files in file browsing in the Inventory directory (Sdcard/inventory/<files>). The files may be copied to a PC.

When **Profile** is set to **Cycle Count** and **Export Data** is enabled: If you start/stop inventory multiple times from the same screen, it will append cycle count data to existing data and generate a csv file (delete old csv) rather than creating a new csv file on each start/stop.

- Tag List Match Mode - Check to enable matching mode.
- Show Friendly Names - Check to show the tag's friendly names instead of EPC ID. Show friendly names is only available when Tag List Match Mode is enabled.

- ASCII Mode - Displays tag ID in ASCII format. If the full tag ID or memory bank data is convertible to ASCII format, then the application only shows the same. Inventory, Locate, Access, and Pre Filters show ASCII mode represented data in respective sections.

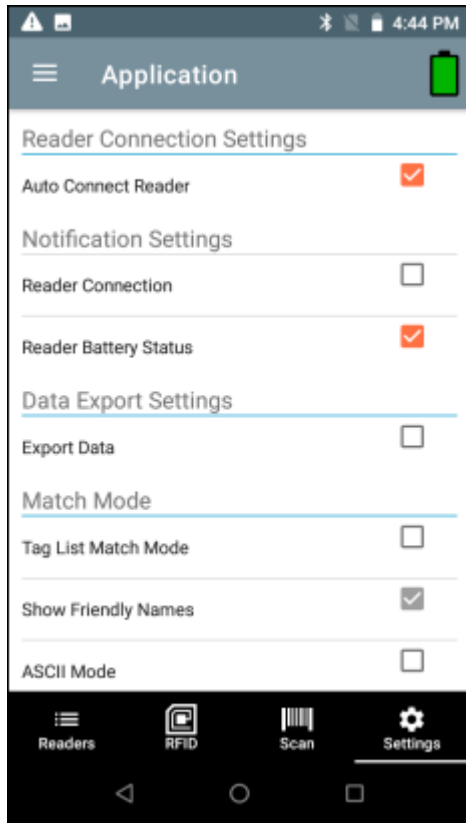

Scan Settings

To access Scan Settings, from the bottom navigation bar, tap **Settings** > **SCAN** or tap  > **Settings** > **SCAN**. Scan Settings options include:

- **Beeper** - allows you to change the beeper volume.



NOTE: Available only on hand-held devices with a scanner (RFD40 Premium and Premium+ and RFD8500 with imager).

- Provides the option to change the scanner beeper volume to high, medium, or low.
- **Symbologies** - Allows users to select/enable specific barcode types. Supported symbologies include UPC-A, UPC-E, UPC-E1, EAN-8/JAN8, EAN-13/JAN13, Bookland EAN, Code 128, GS1-128, Code 39, Code 93, Code 11, Interleaved 2 of 5, Discrete 2 of 5, Chinese 2 of 5, Codabar, MSI, Code 32, Data Matrix, PDF417, ISBN, UCC Coupon Extended Code, ISSN EAN, ISBT 128, Trioptic Code 39, Matrix 2 of 5, Korean 3 of 5, GS1 DataBar-14, GS1 DataBar Limited, GS1 DataBar Expanded, MicroPDF417, Maxicode, QR Code, Aztec, Han Xin Code, Australian Post, US PLANET, US POSTNET, Netherlands KIX, USPS 4CB, UK Postal, Japan Post, UPU FICS, MicroQR, Composite C, Composite AB, TLC39, Dot Code.
- **Picklist Mode** - Toggle to turn picklist mode on or off. Default is Off.
- **Aim Guide** - Provides an aimer light which can be switched on or off.

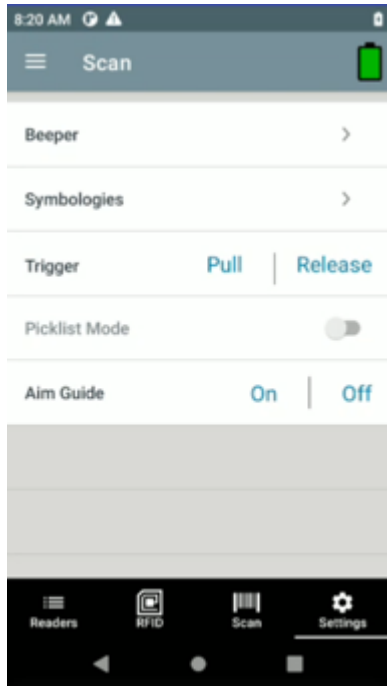

Getting Help

On-screen help is available within 123RFID Mobile Application.

To access the Help screen, tap  > **Settings** > **Help** or when available, tap the ? icon in the upper right hand screen.

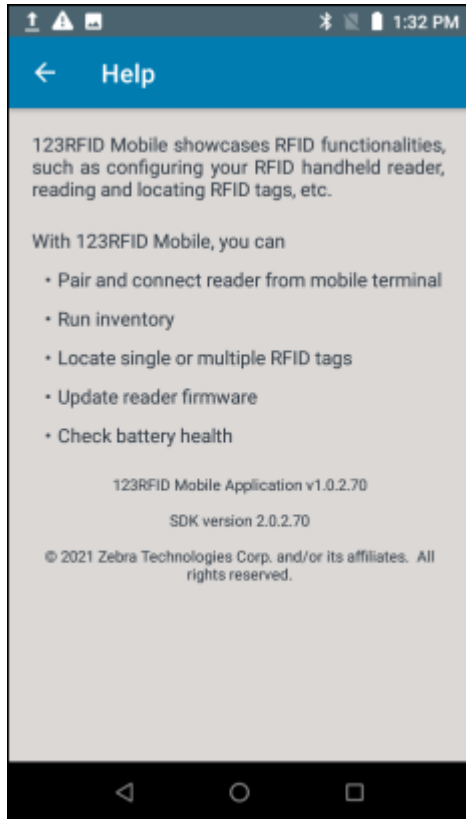

123RFID Desktop Application

123RFID Desktop is a setup and optimization tool for RFID sleds. This section describes the application and its features.

Application Features

- Connect - allows users to search for readers on the local subnet, USB port, or Bluetooth.
- Read - allows users to start an inventory, view summary metrics on tag reads, and sort, filter, and export tag data. Select an antenna and set the power level to begin building an inventory.
- Configure - allows users to configure reader and scanner settings. Settings can be saved to a file or as a printed report.
- Firmware - allows users to update the firmware on up to five devices.

Connect

Users can locate readers on the local subnet or via USB port by clicking the Find Readers button or by entering the IP, hostname, COM port, or by Bluetooth and clicking Connect.

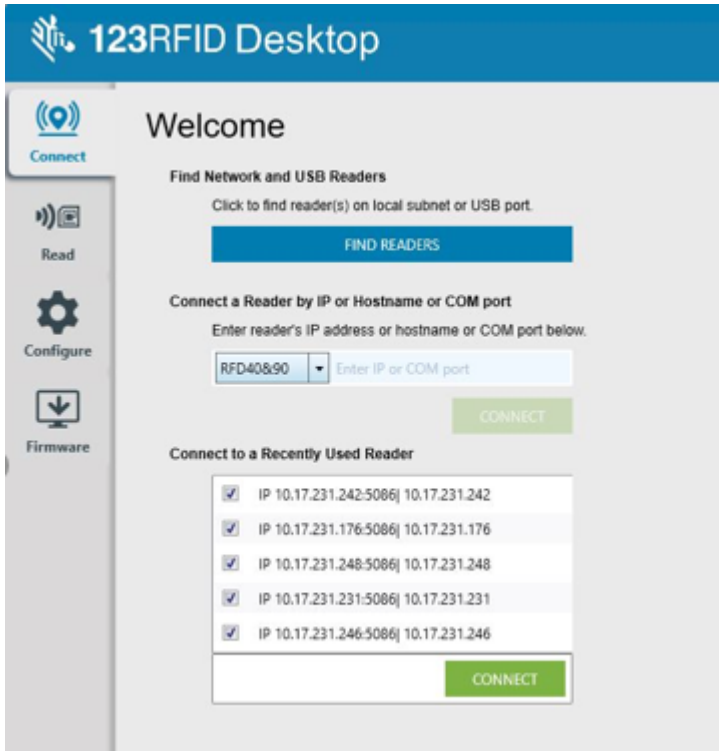

To discover readers on the network, view the Available Readers section of the application and click Connect on one of the associated rows to connect to the specified reader.

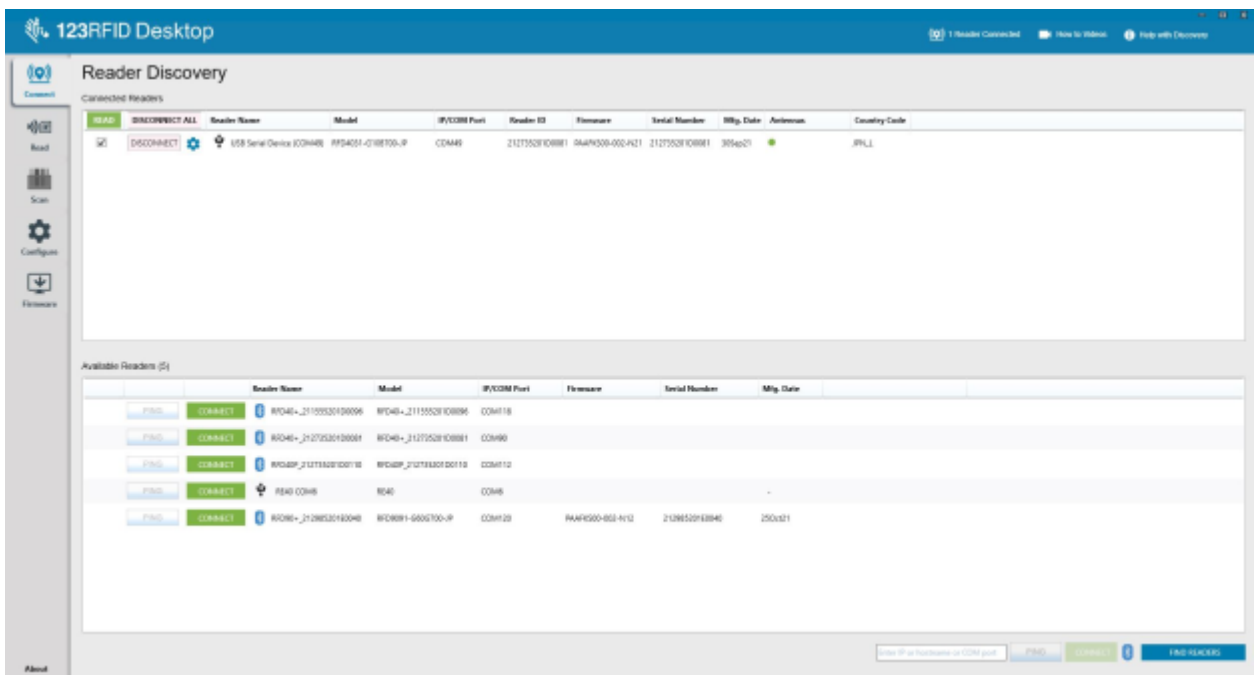

Read

The read feature allows users to start an inventory. Users can view summary metrics on tag reads by the reader, sort, filter, and export tag data to a file. Select antenna and set the power level to do inventory.

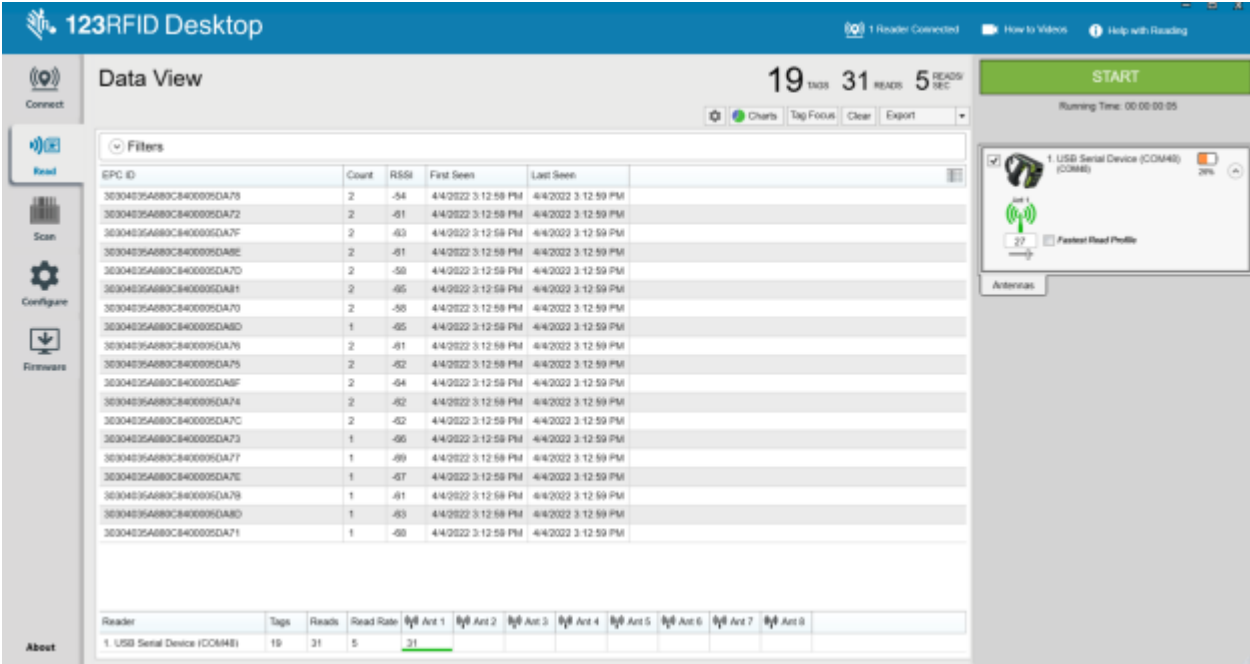

Click the Start button to start reading tags and recording an inventory.

To download the inventory data for offline viewing, click the Export button to export tag data to excel.

- Export Summary - save a snapshot of all the tag reads displayed on the Read screen in excel.
- Export History – save timeline data for tags read in excel.

Right-click on a specific tag row to edit access operation information on the tag.

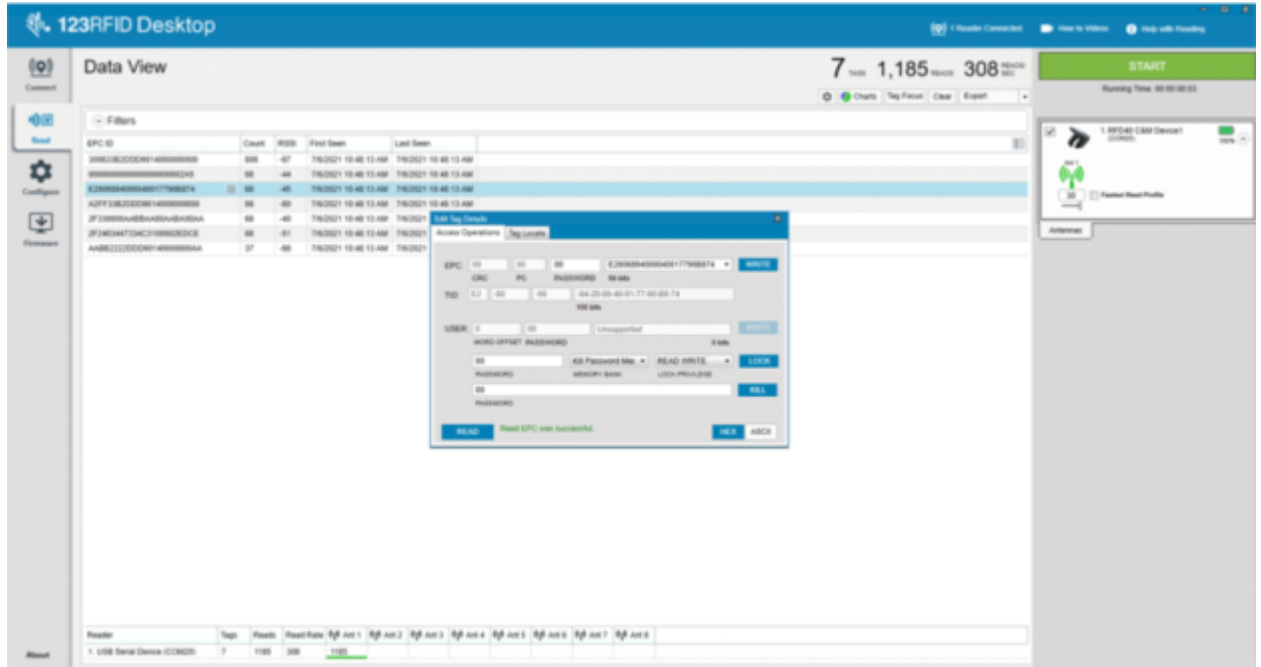

To access specific tag location details, click the Tag Locate tab.

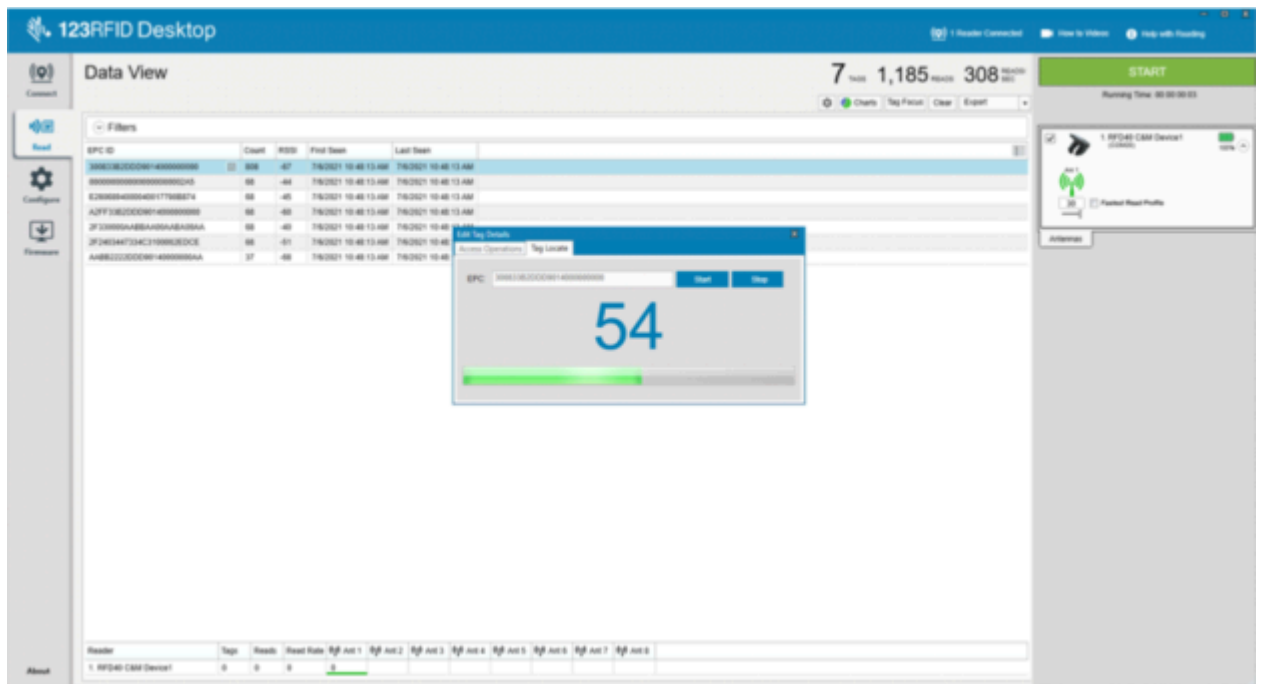

Reader Configuration

The Reader Configuration wizard configures the reader and antenna settings and saves them instantly. Users can also save settings to a file on the PC or print a report.

Click Edit Configuration on Reader to edit the reader's settings and use the wizard to do the following.

- Assign names to the reader and its connected antennas.

123RFID Desktop Application

- Set reader settings or reset them to factory defaults.
- Change the reader's region configuration.
- Create rules for your GPIO (General Purpose Input/Output) accessories on when to trigger inventory and output results.
- Save/print configurations to a file.
- Deploy the configuration file to a new device.

Click Open Configuration to load a saved configuration file to another connected reader from the PC.

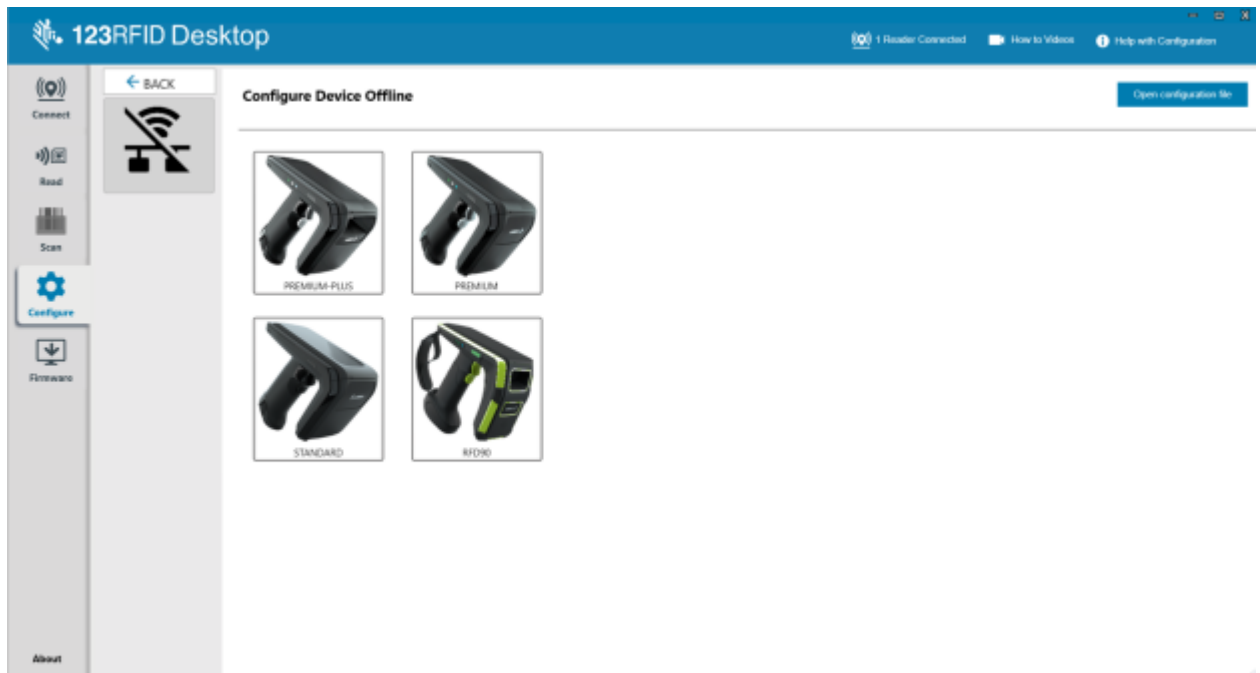

Beeper volume, dynamic power, off mode timeout duration, and Bluetooth discovery settings are configurable for online readers.

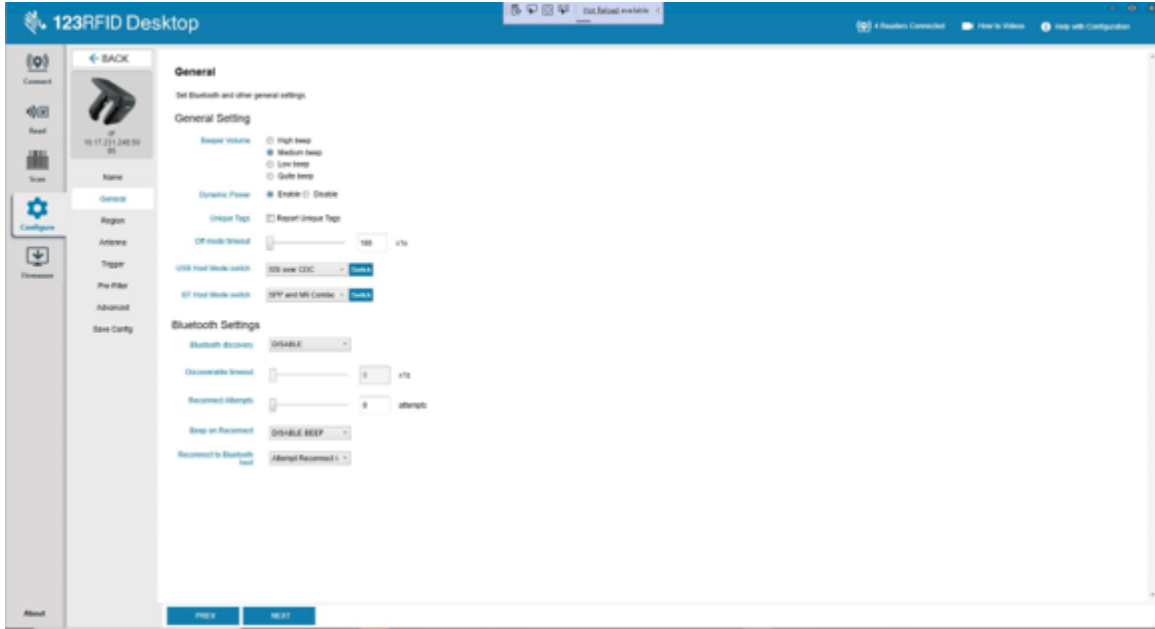

Reader Name

Add a description or name the reader by filling out the form fields on the name screen

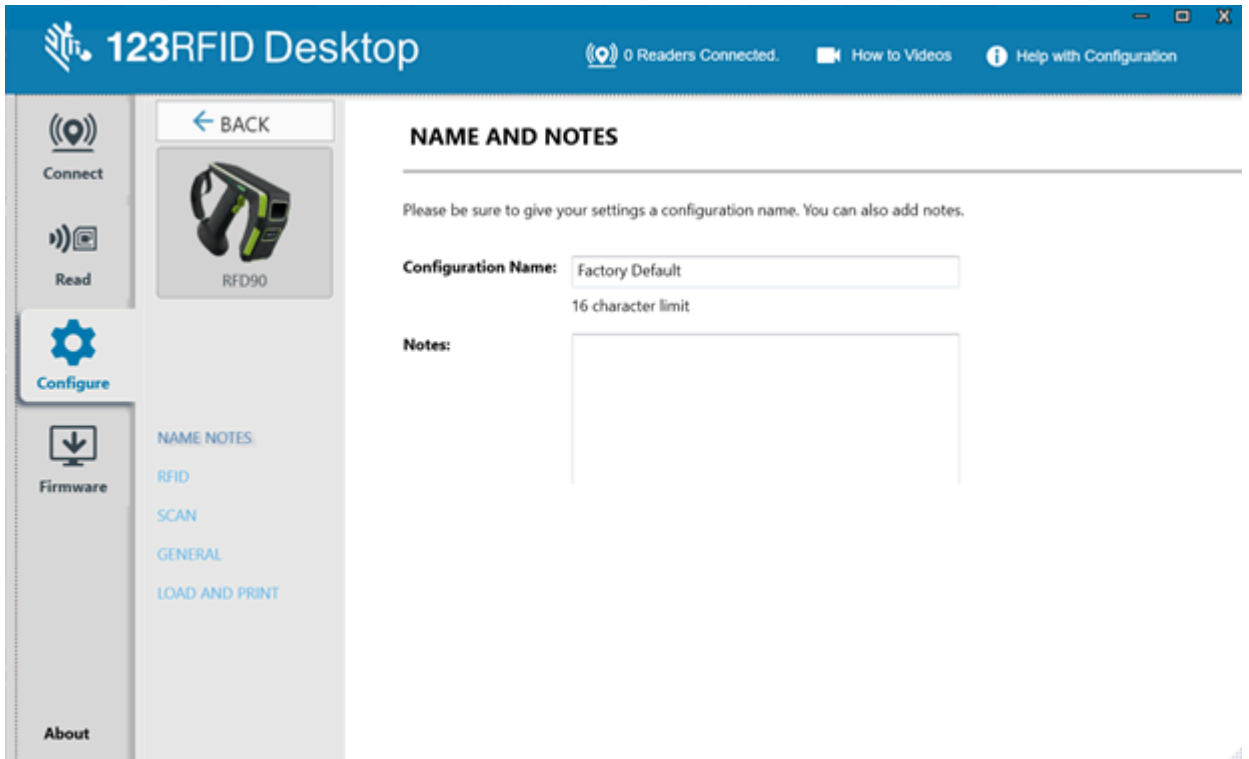

Parameter Settings

General Settings that are configurable include enabling Bluetooth Batch Mode, setting a delay before data is transmitted in Batch Mode, setting the Bluetooth Host Type, and setting the USB Host Type.

HID Keyboard Options include selecting the country code and keystroke delay. Bluetooth settings include enabling the device to attempt to reconnect automatically upon losing connection, beeper feedback when the device reconnects, setting a timeout period for the device to become discoverable, and automatically attempting to reconnect to the Bluetooth host. Beeper Settings include volume, tone, whether the sled beeps to confirm a successful decode, and the ability to suppress power-up beeps.

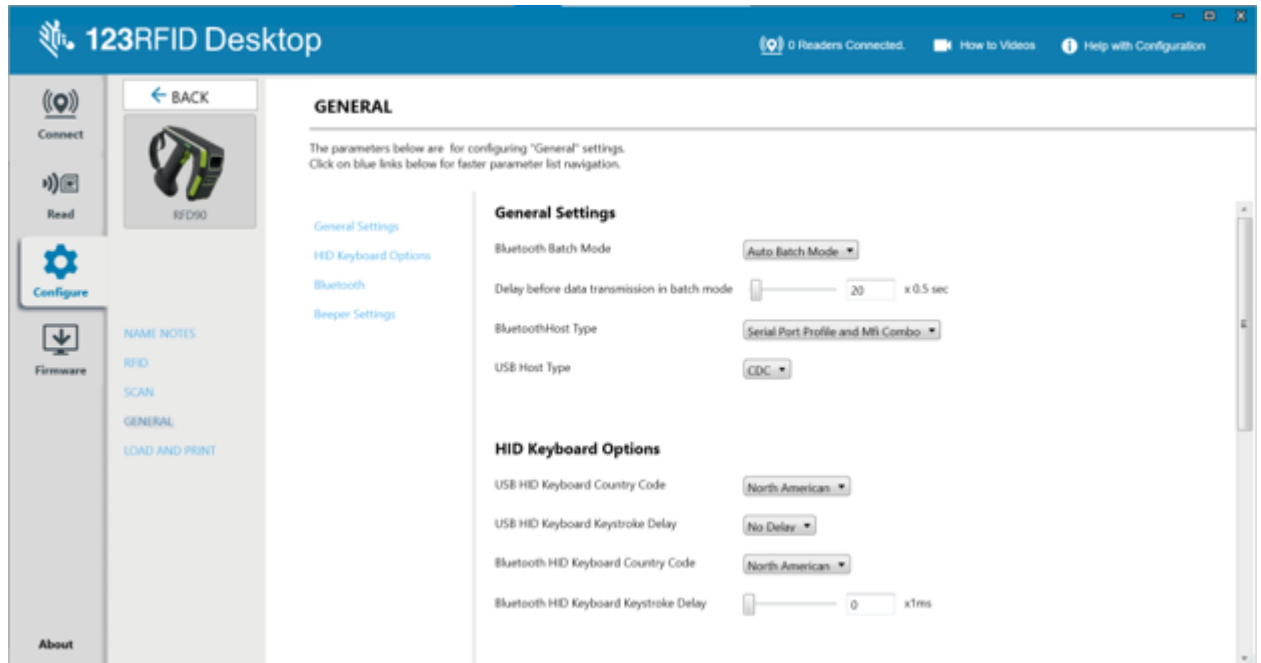

Scanning Configuration

Configurable scanning settings include enabling or disabling specific symbologies and enabling/disabling particular settings at the system level, such as transmitting the no-read message or the device's trigger mode.

- Symbology Settings – users can configure and enable/disable specific symbologies.
- System Settings – users can configure and enable/disable specific settings at the system level, such as transmitting the no-read message or the device's trigger mode.

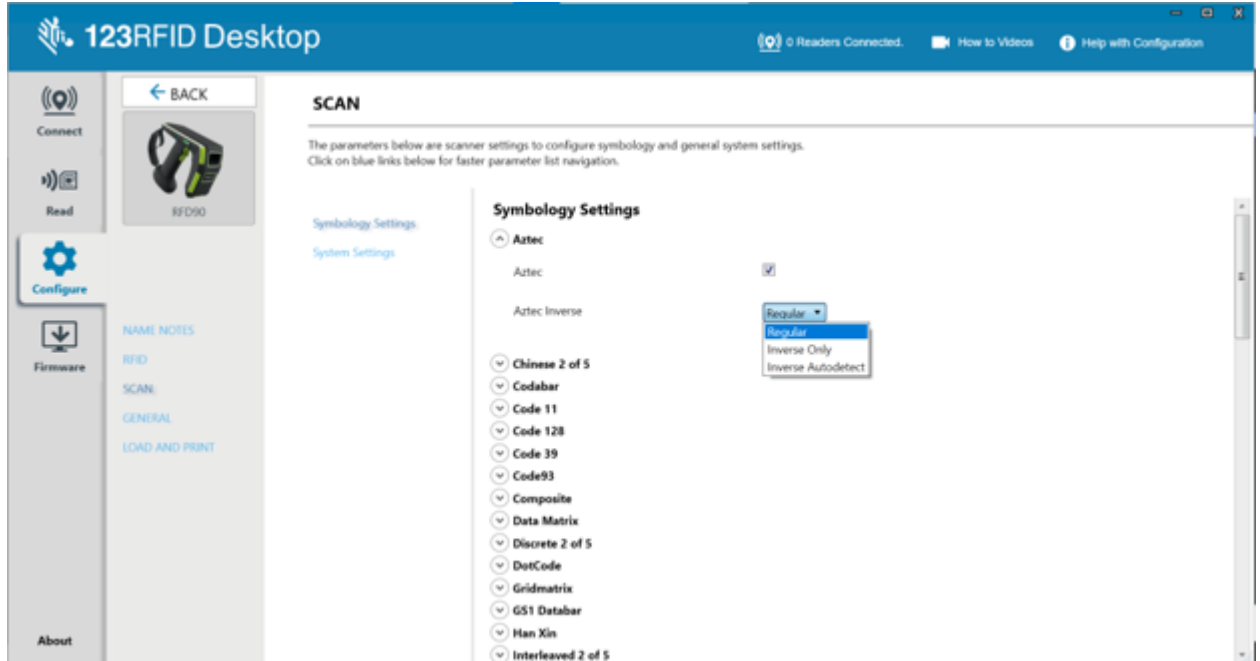

RFID Configuration (Offline)

Configurable options for offline readers include regulatory configuration, RFID data reporting, filter and querying options, trigger, and advanced options.



NOTE: Ensure that the reader is configured for the correct region it is used in. Configuring the device for a different region is illegal.

Offline Configurable options include:

- Regulatory Configuration options such as setting the country of operation and enabling or disabling Channel Hooping and Channel Mask.
- RFID Data Reporting options such as first and last time seen time stamps, RSSI, phase difference, unique tag reporting, and the total amount of tags seen.
- Advanced Configuration options such as enabling Link Profile, configuring the RFID Transmit Power Level, and enabling dynamic power optimization.
- Filter Options for up to four filters, including Filter enable, target, action, memory bank, truncate, length, start position, and mask.
- Query Options such as selecting which tags, session, and target the query is applied to.
- Trigger Configuration such as defining RFID operations and the conditions in which they are initiated and stopped.

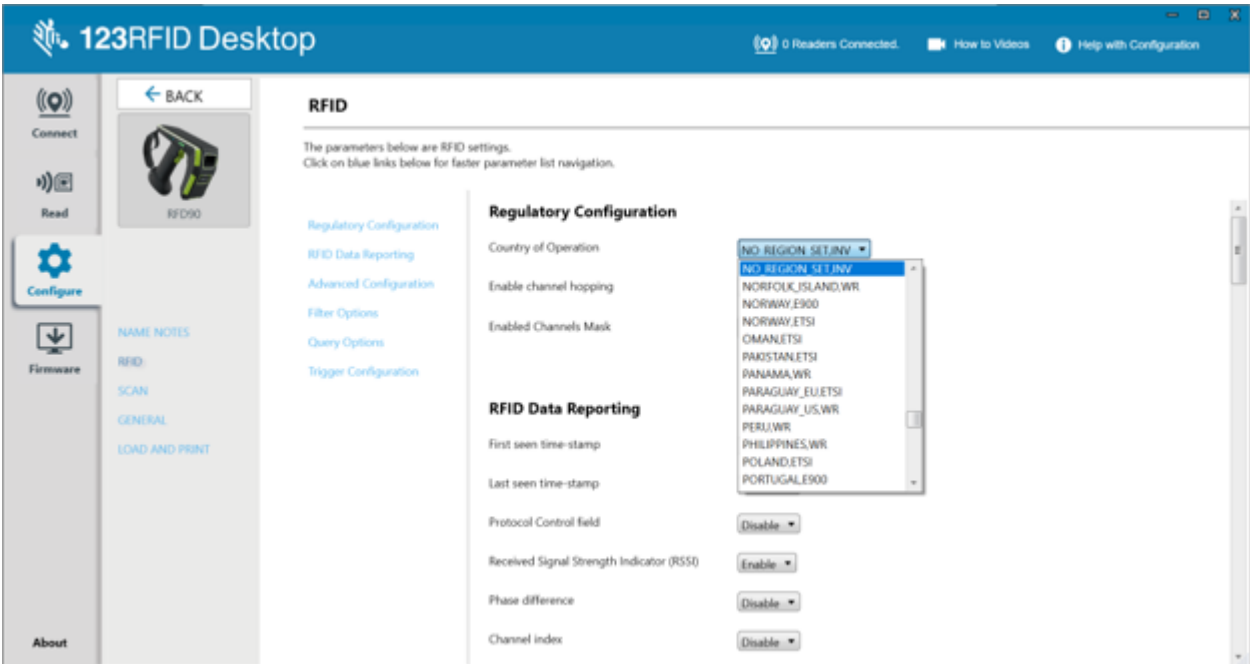
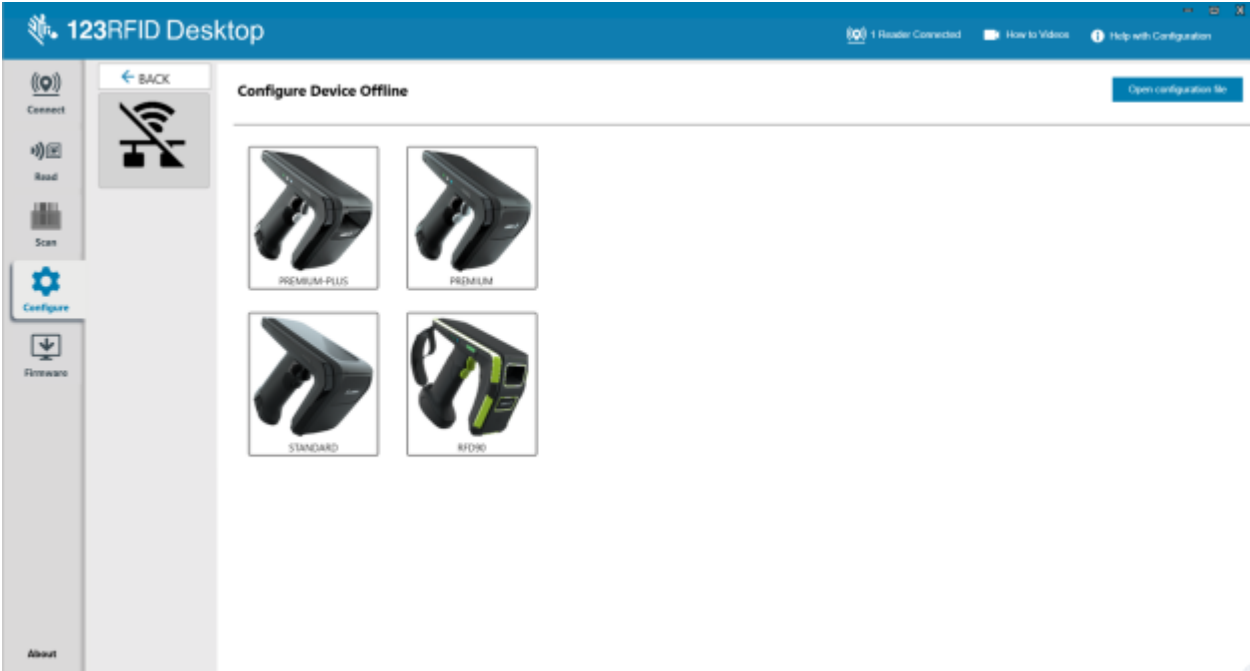

RFID Configuration (Online)

Configurable options for offline readers include regulatory configuration, RFID data reporting, filter and querying options, trigger, and advanced options.

When connected via IP, Edit the configuration of the reader or load a saved configuration onto the device.

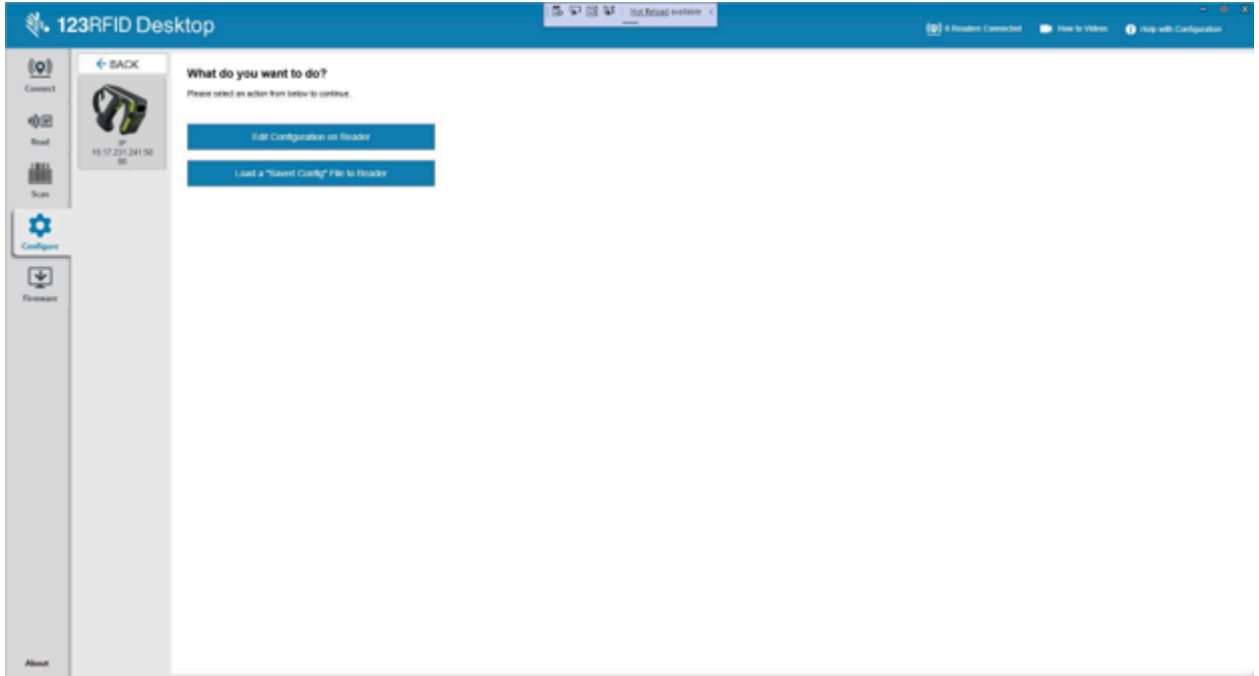

NOTE: Ensure that the reader is configured for the correct region it is used in. Configuring the device for a different region is illegal.

Online Configurable options include

- General Settings
- Regulatory Configuration options such as setting the country of operation and enabling or disabling Channel Hooping and Channel Mask.
- Antenna
- Trigger Configuration such as defining RFID operations and the conditions in which they are initiated and stopped.
- Pre-Filtering
- Advanced
- Scanner Configuration

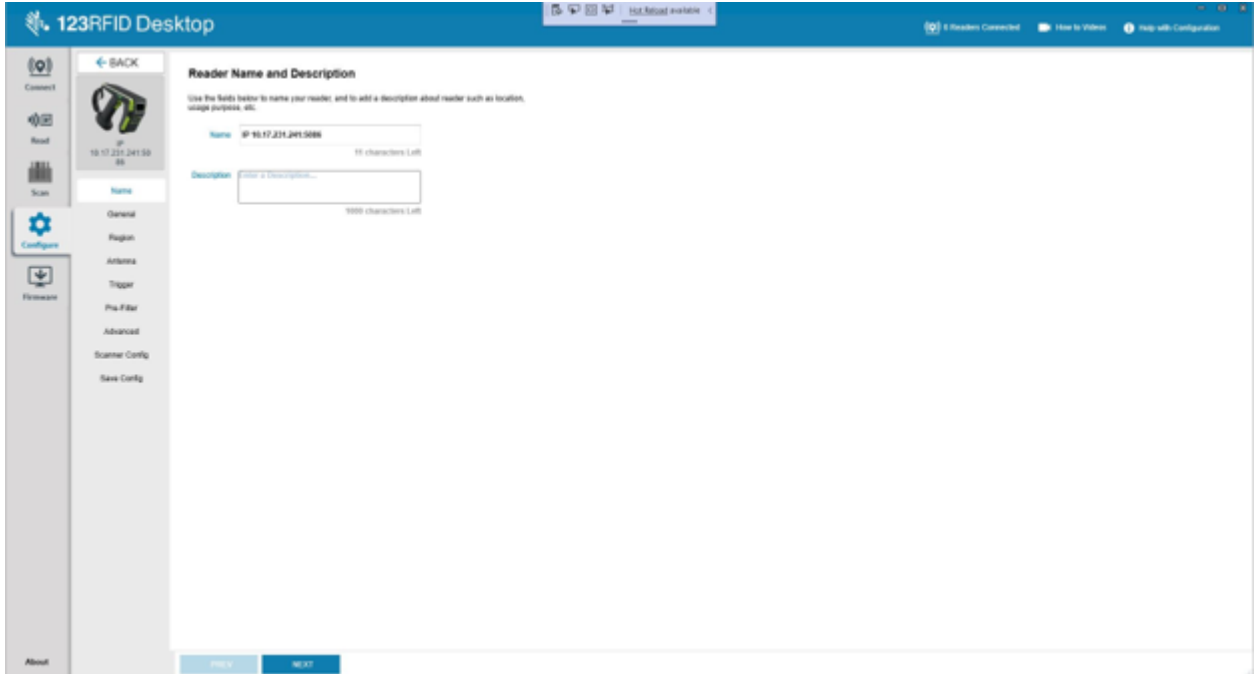

Configuring the Timeout Setting

The 123RFID Desktop can be used to configure the device off mode timeout. By default, the off-mode timeout is thirty minutes. If the device is not engaged in any operations for this specified time, it enters deep sleep mode.

To configure the Timeout while the reader is online:

1. Run 123RFID Desktop
2. Click Find Readers and observe the Available Readers section.
3. Click Connect to initiate a connection with the associated reader in the Available Readers section. Once connected, the reader is listed in the Connected Reader section.
4. Select the Configure tab and select the reader to begin editing the configuration on the reader.
5. Under General Settings, observe the Off Mode Timeout value and move the slider to the specified amount of time the reader is to run while idle until it enters deep sleep mode.
6. Save the configuration in either .rfdcfg or .DAT format on the LOAD and PRINT screen.

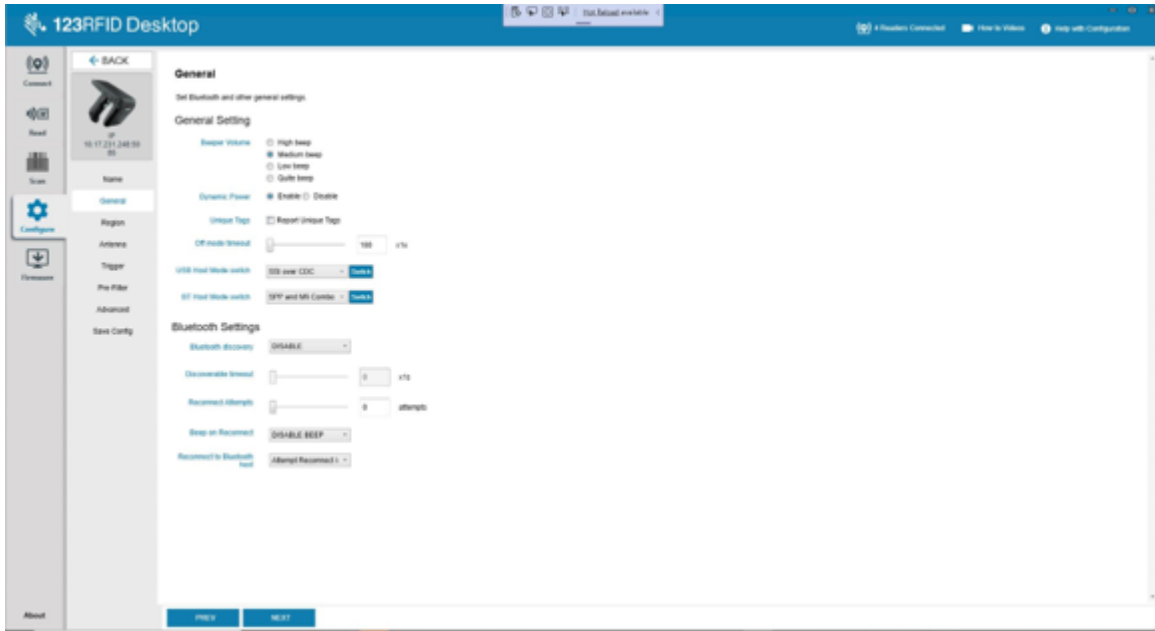

To configure the Timeout while the reader is online:

1. Run 123RFID Desktop
2. Select the Configure tab and click on Offline config.
3. Select the plugin type.
4. Set the appropriate region configuration settings.
5. Under General Settings, observe the Off Mode Timeout value and move the slider to the specified amount of time the reader is to run while idle until it enters deep sleep mode.
6. Save the configuration in either .rfdcfg or .DAT format on the LOAD and PRINT screen.

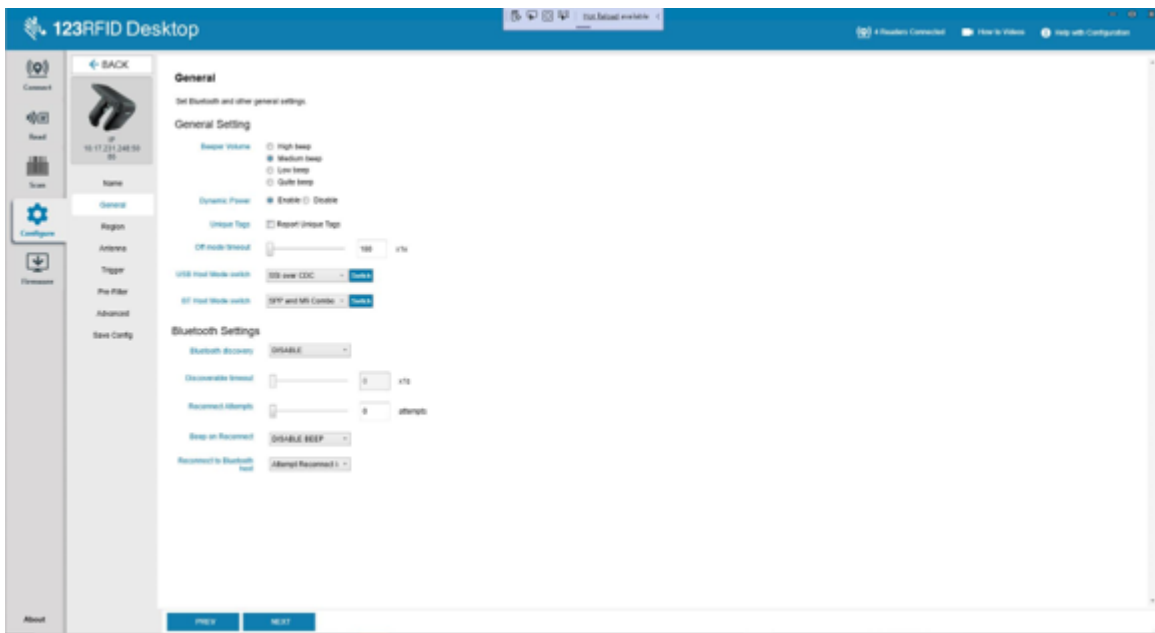

Print Configuration

Load the configuration file to the PC, push the antenna settings to the reader, or reset the antenna settings to factory defaults at the end of the configuration workflow.

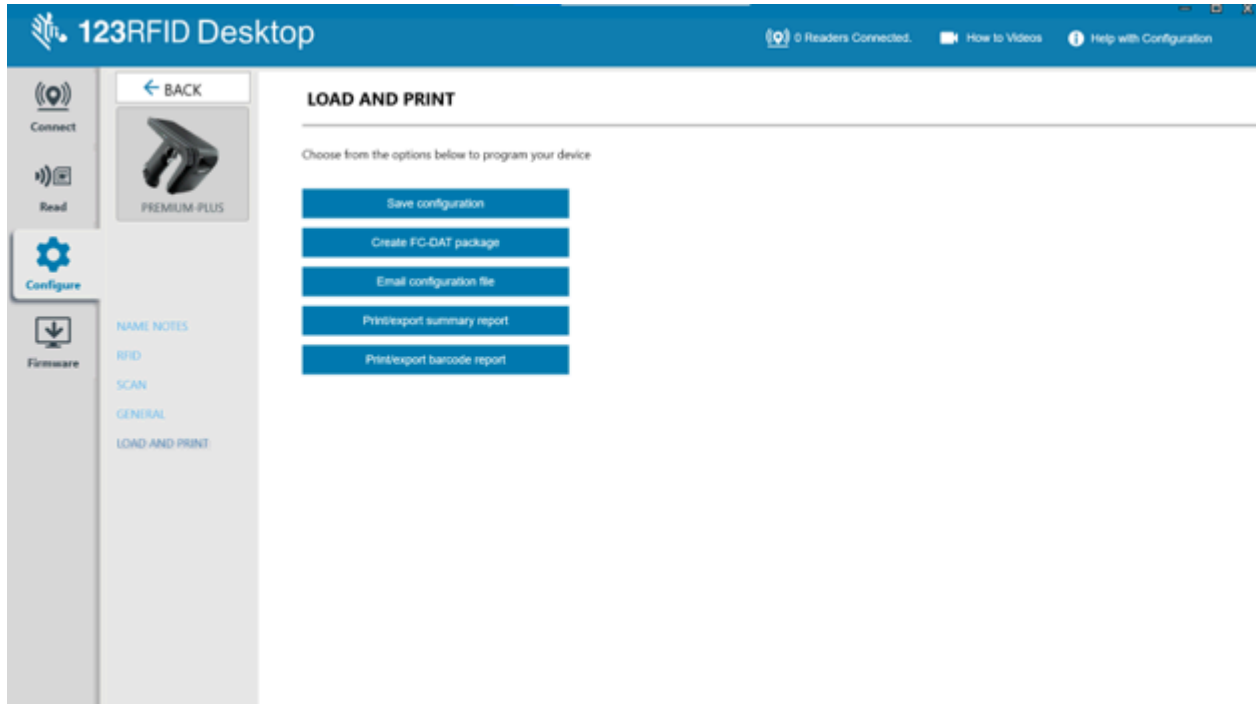

Bluetooth Settings

123RFID Desktop tool can be used to discover, connect, and configure Bluetooth settings for online and offline readers. This section provides information about Bluetooth configuration changes for online and offline readers, including enabling and disabling discovery and configuring the discovery time out.

There are three modes of Bluetooth discovery:

1. Always discoverable: Enabling Bluetooth discovery and setting the discoverable timeout value as 0 changes the Bluetooth to always be discoverable and always available for pairing.
2. Never discoverable: Disabling Bluetooth discovery changes the Bluetooth to never be discovered and the device is not available for pairing.
3. Limited discovery or Time Out: Enabling Bluetooth discovery and providing the Discoverable timeout value makes the device pairable for the specified time.

To configure online Bluetooth settings:

1. Launch 123RFID Desktop
2. Click Find Readers. Readers that are available to connect are listed under the Available Readers section.
3. Click the Connect button next to the readers you intend to connect with. Once connected, the reader moves and is listed under Connected Readers.
4. Click Configure, select the reader, and then Edit configuration on the reader, followed by General.

5. Change Bluetooth Discovery and Discoverable timeout values to the desired time range. These updated settings are directly applied to the readers.

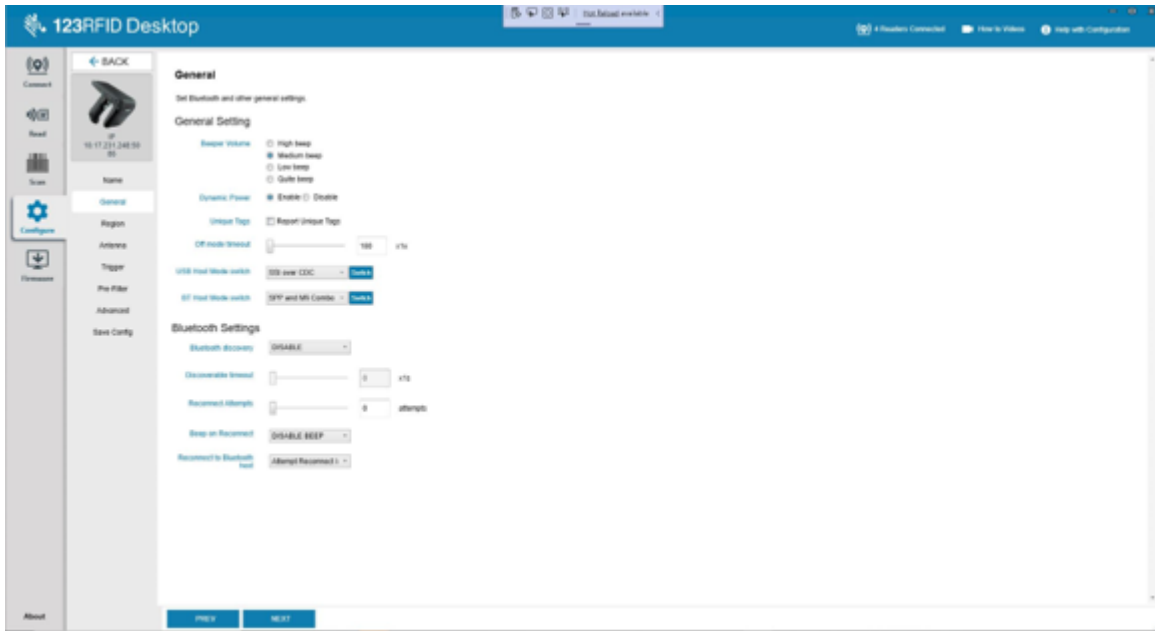

To configure offline Bluetooth settings:

1. Launch 123RFID Desktop
2. On the Configure tab, click Offline Configuration and select the Plugin Type as Bluetooth.
3. Configure the Bluetooth settings and save the configuration in either .rfdcfg or .DAT format.

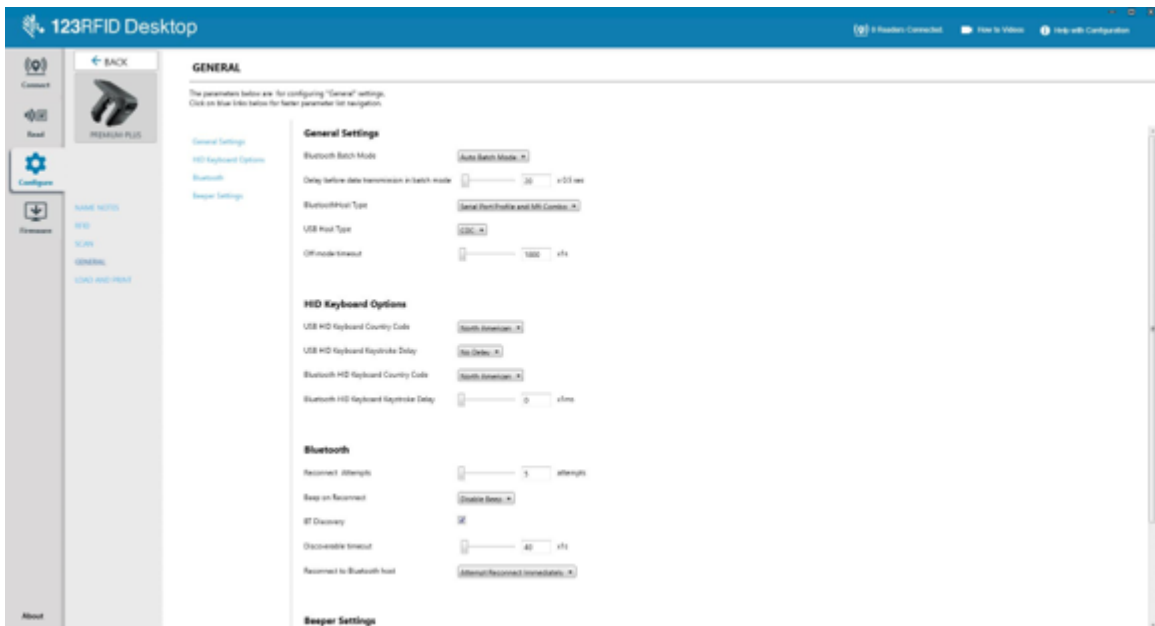

To connect the reader and load the configuration file:

1. Select the reader on the Configure Tab and click Load a Saved config file to the reader.
2. Browse to the saved configuration file. The load configuration window displays.

3. Click Load Configuration to Readers.

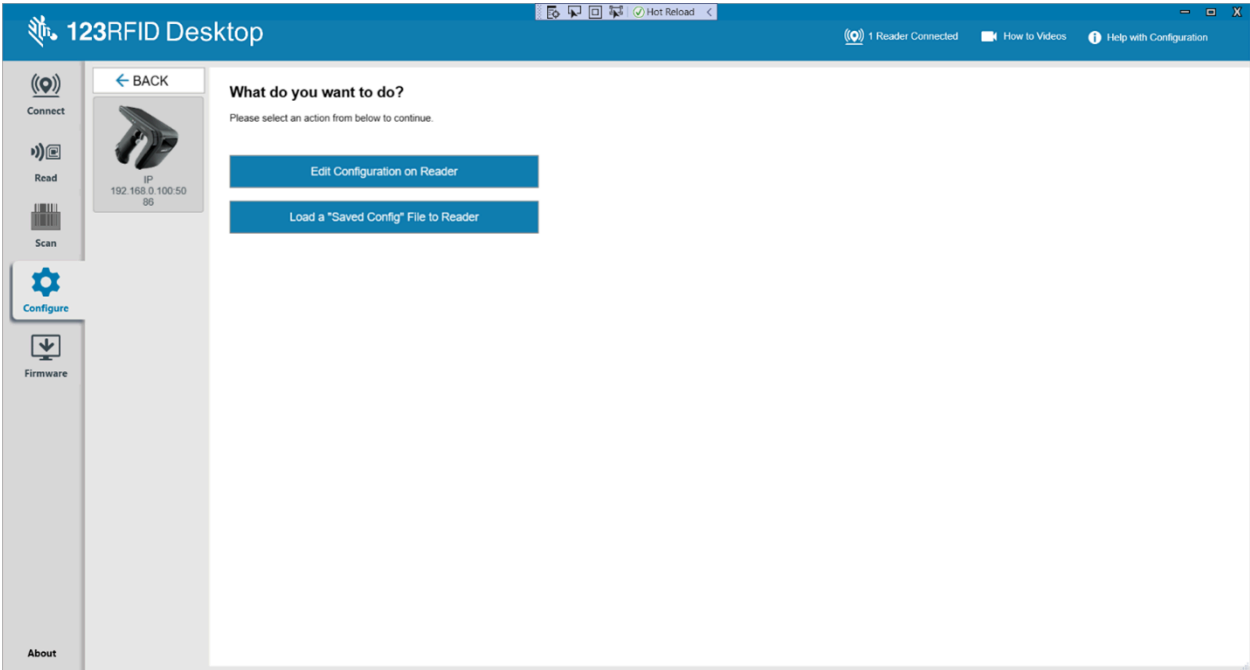
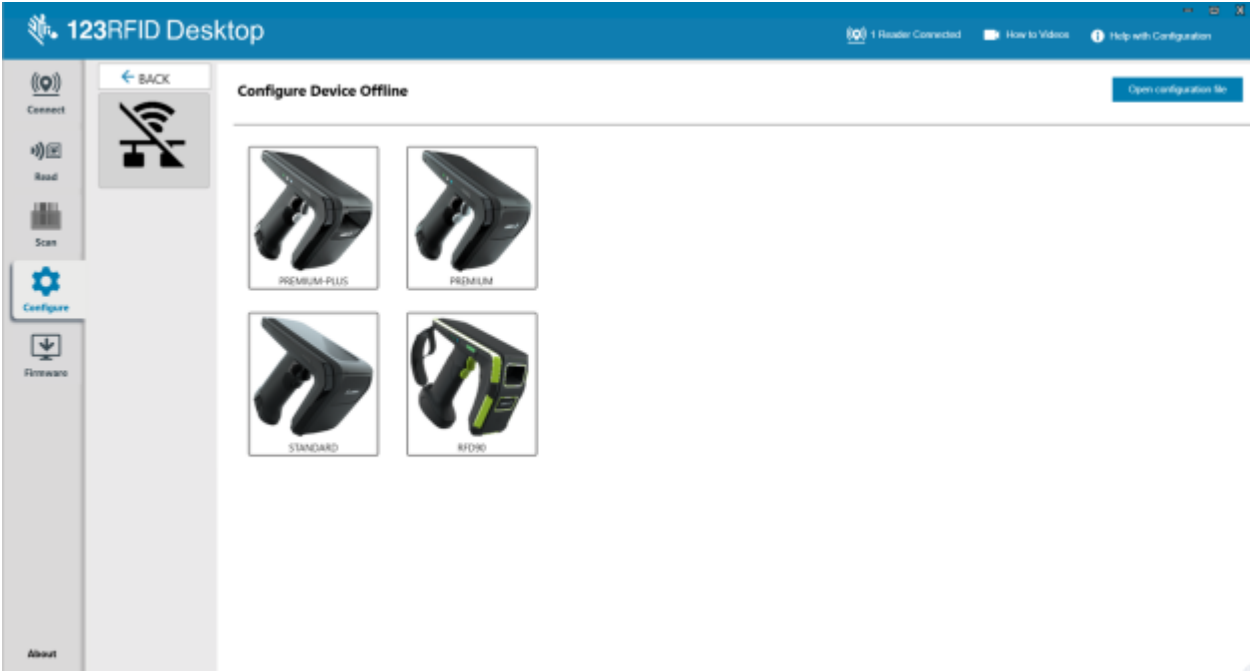

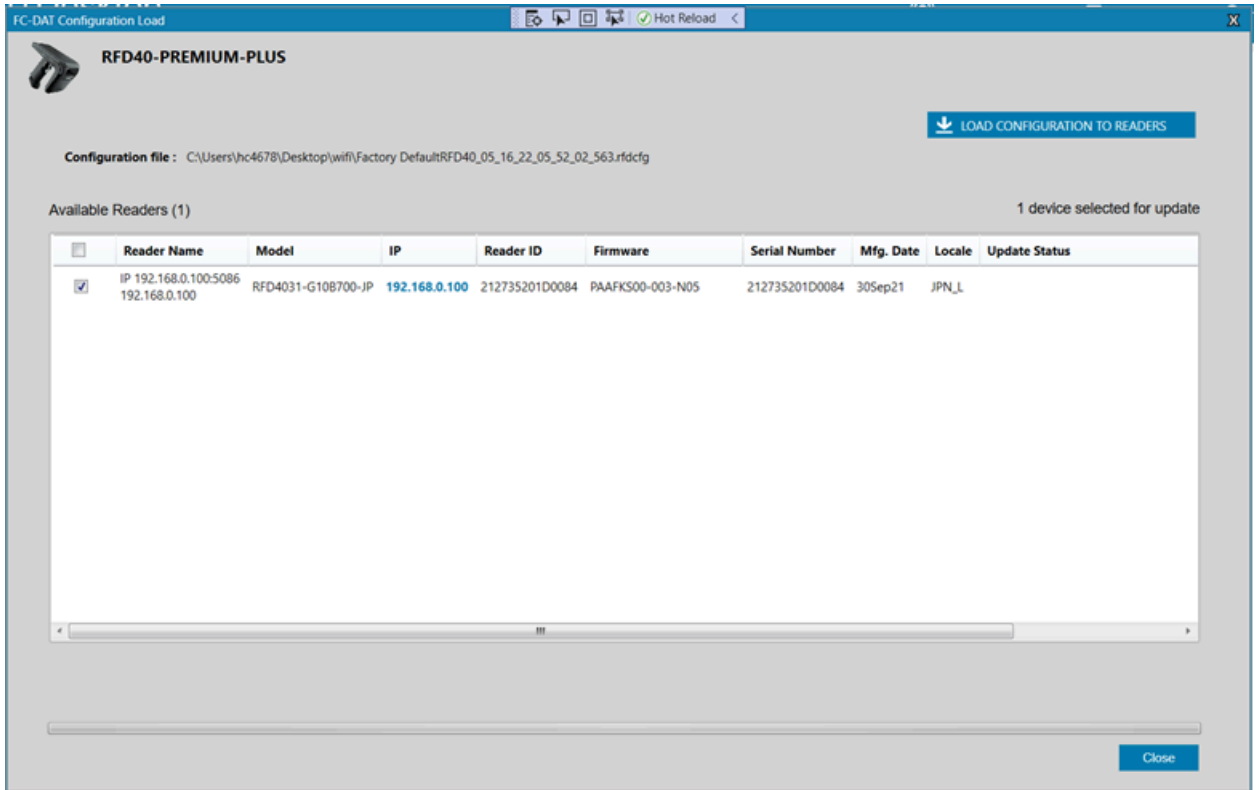

Firmware Management

To update reader firmware on up to five devices simultaneously, select the devices on the table by clicking the associated checkbox and clicking the Update Firmware button.

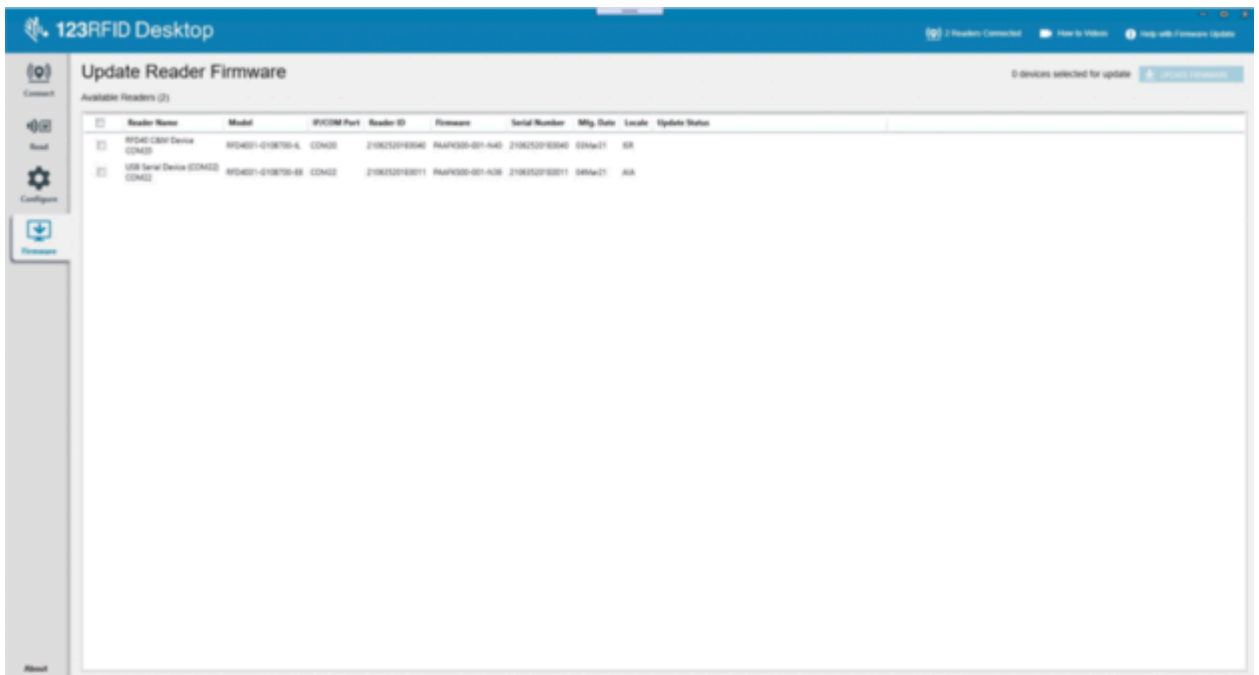

123RFID Desktop Application

Next, the Reader Firmware Update window displays. Click Browse to select the firmware version to be enabled onto the selected device.

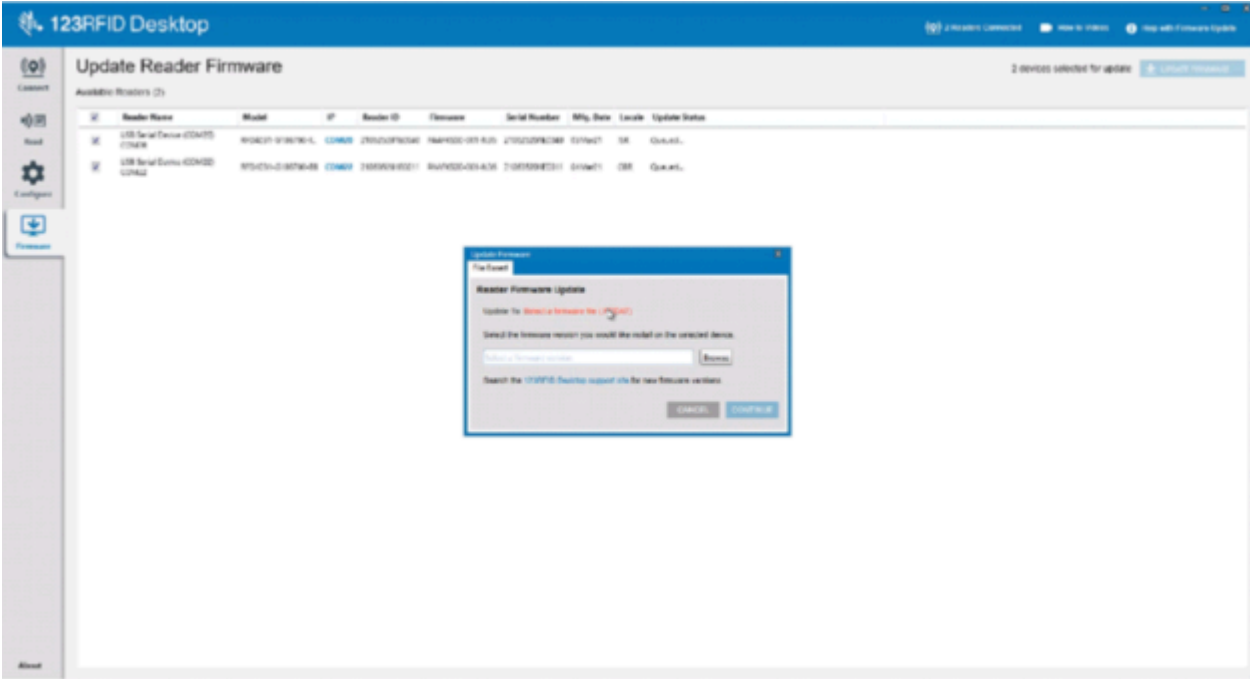

Once the firmware file is selected, the update starts and the progress bars next to the associated readers indicate the completion percentage of the update.

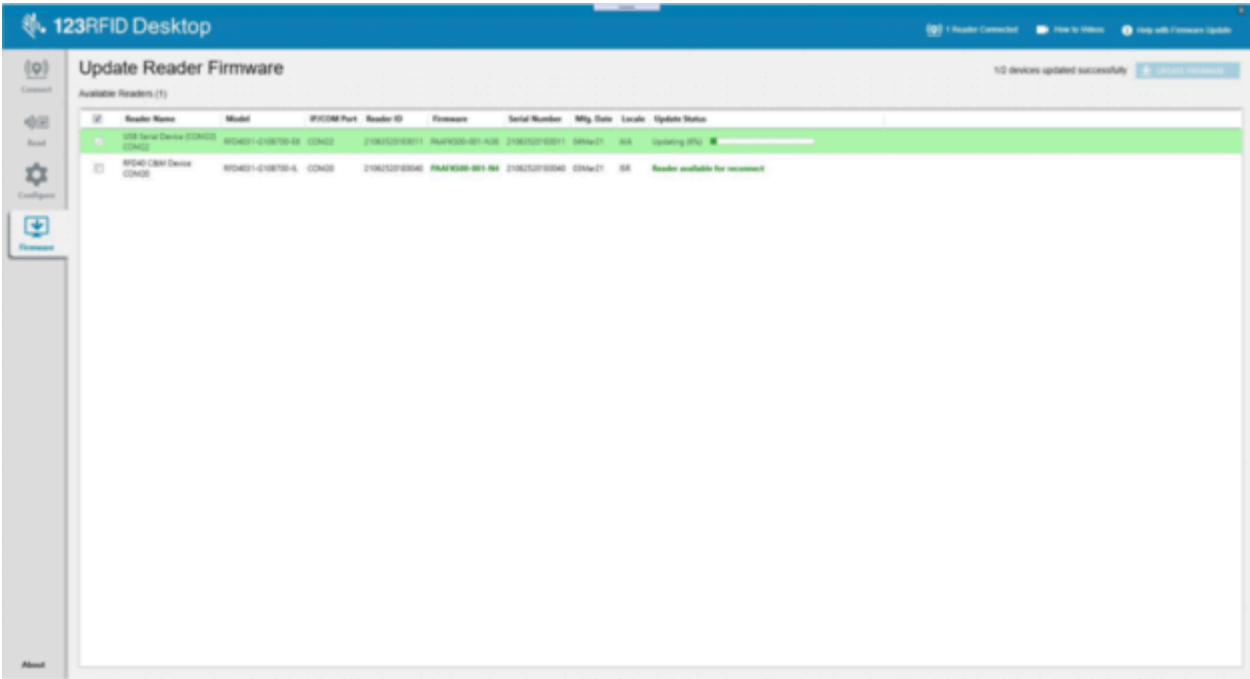

Connecting to the Multi-Slot Cradle

The 123RFID Desktop tool can also be used to discover, connect, and perform RFID and scanning operations for Zebra UHF RFID sleds using the multi-slot cradle. This section provides the steps necessary to discover and connect to the multi-slot cradle.

To discover and connect to the device:

1. Keep the device in the cradle and run 123RFID Desktop.
2. Click Find Readers to view available devices to connect to.
3. Click the Connect button next to the device to connect to it. Once connected, the device will be listed under the Connected Readers section.

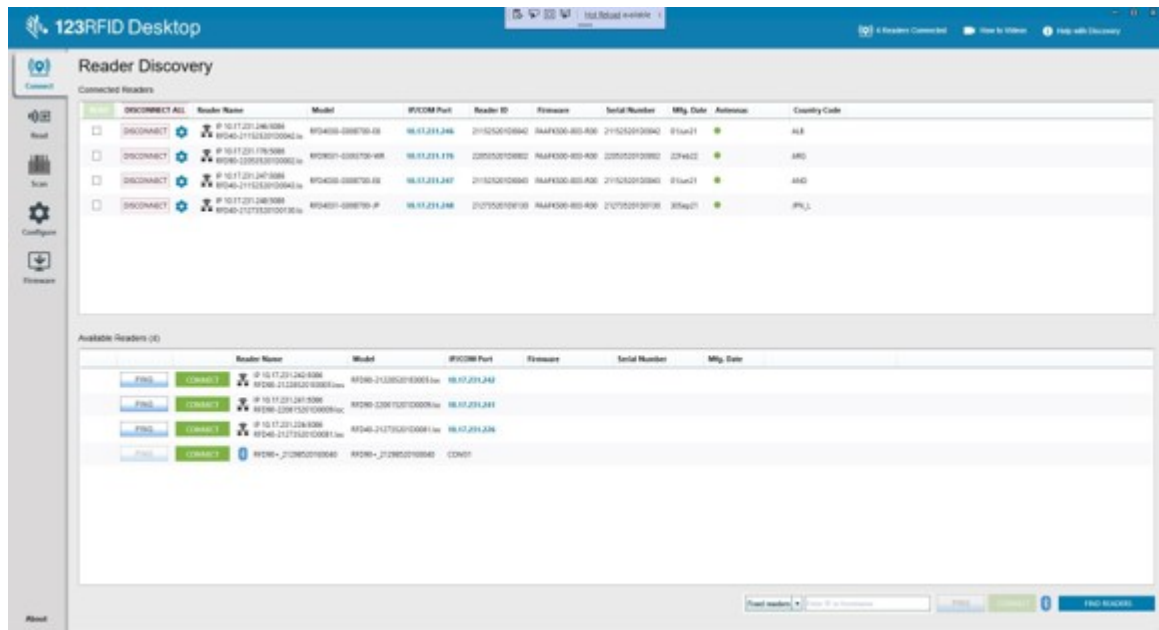

To connect a device via IP address:

1. Keep the sled docked in the cradle for up to 2 minutes while the DHCP allocates the IP address and it becomes visible.
2. Remove the sled and connect it via USB or Bluetooth.
3. Connect to the ZETI port using tera-term.
4. Issue the connect command.
5. Issue log .0 2 .c 3
6. Observe the IP address from the log display, as shown below

```
[0007312149]:  
  CHARGING_IN_PROGRESS  
[0007312301]:IP: 0.0.0.0 Mask: 0.0.0.0 Gateway: 0.0.0.0  
[0007312301]:Host[type 18 variant 255] Installed in 7312301 ms  
[0007313172]:mdns_cradle_startup: failed in tx_thread_create  
[0007313172]:zeti_cradle_start: success  
[0007314210]:DHCP SERVER IP: 10.17.216.200  
[0007314210]:DHCP GATEWAY: 0.0.0.0  
[0007314210]:DHCP IP: 10.17.231.183  
[0007318149]:wakeNGERadio(0)  
[0007318155]:Radio Sleep  
[0007328766]:USB ETH CRD OUT  
[0007328766]:OUT OF CRADLE  
[0007328767]:SYSEXEC_MSG_ETH_USB_Uninstall  
[0007329228]:zeti_cradle_shutdown: success  
[0007330067]:>SYSEXEC_MSG_HOST_CHANGE
```

Once the IP address is identified, run 123RFID Desktop.

1. Choose RFD40&90 from the dropdown and enter the IP of the device.
2. If the ping is successful, click Connect. The reader is now listed in the Connected Readers section.

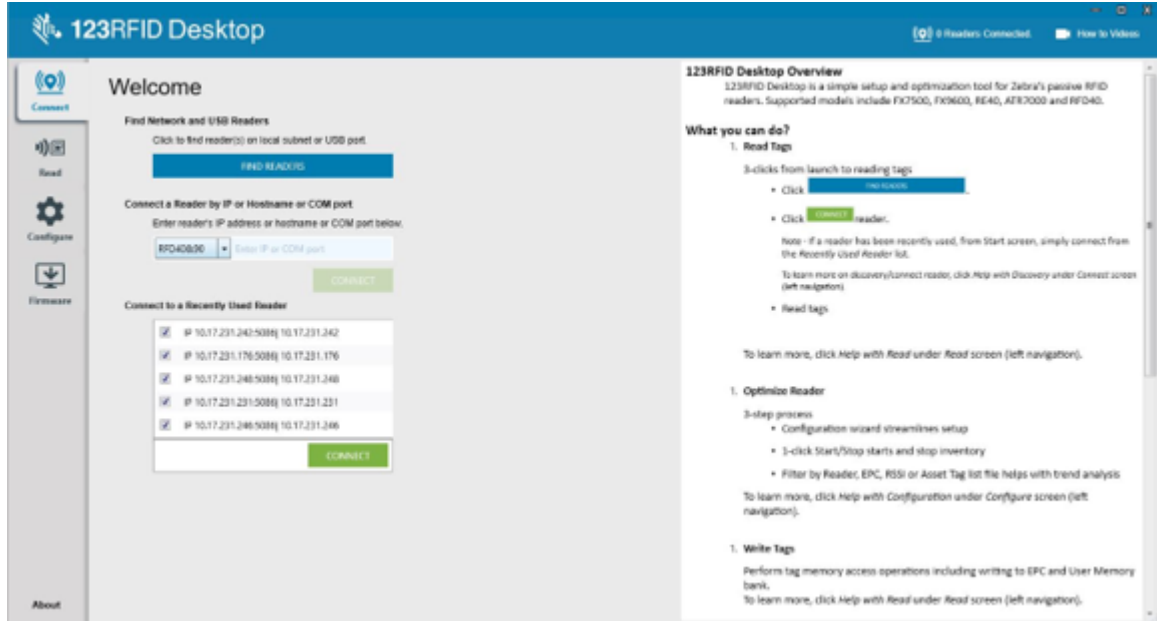

Configuration Creation

The 123RFID Desktop application provides users with the ability to create, save, and deploy configurations.

To create a new configuration file:

1. Launch the 123RFID Desktop application and open the Configuration tab.
2. Select Offline configuration.
3. Select the reader that the new configuration is to be deployed on.
4. Add Configuration Name & Notes for the new configuration file & Giga-DAT File.
5. Select the proper region information for the regulatory section.
6. For RFD40 Premium+ and RFD90 devices only, configure the scanning parameters from the Symbology and System settings.
7. Configure Bluetooth and Beeper Settings on the General Settings panel.
8. Save the configuration file locally on the PC by clicking Save configuration.

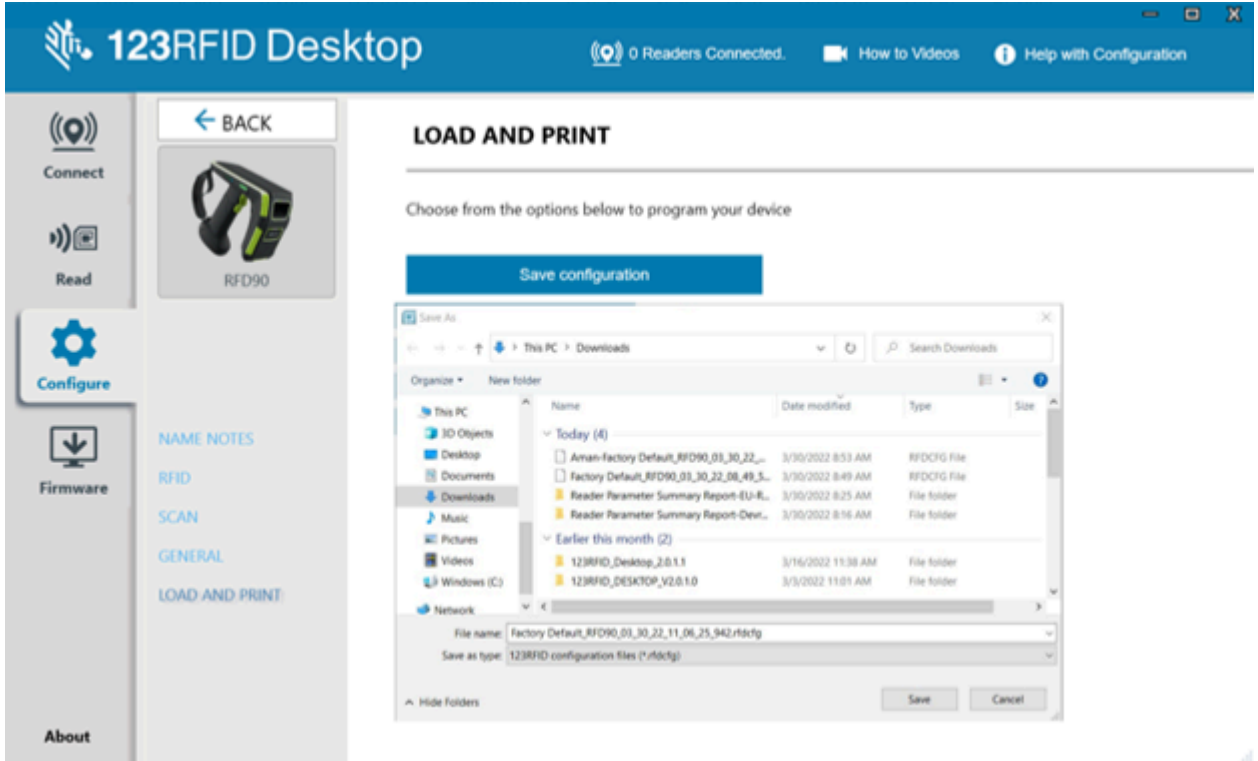

To create a Giga-DAT package, begin by following steps 1-8 from the procedure above.

1. Click Create Giga DAT package.
2. Click Select Firmware file in the State Configuration window.
3. Navigate to the appropriate configuration file and click Open. The firmware file name displays in the Stage Configuration window.
4. Click Save to save the Giga DAT file.
5. Determine the location to save the new Giga-DAT File with the configuration and click Save. The new Giga-DAT File displays in this format: - GSAAFKS00-002-R04E0.DAT

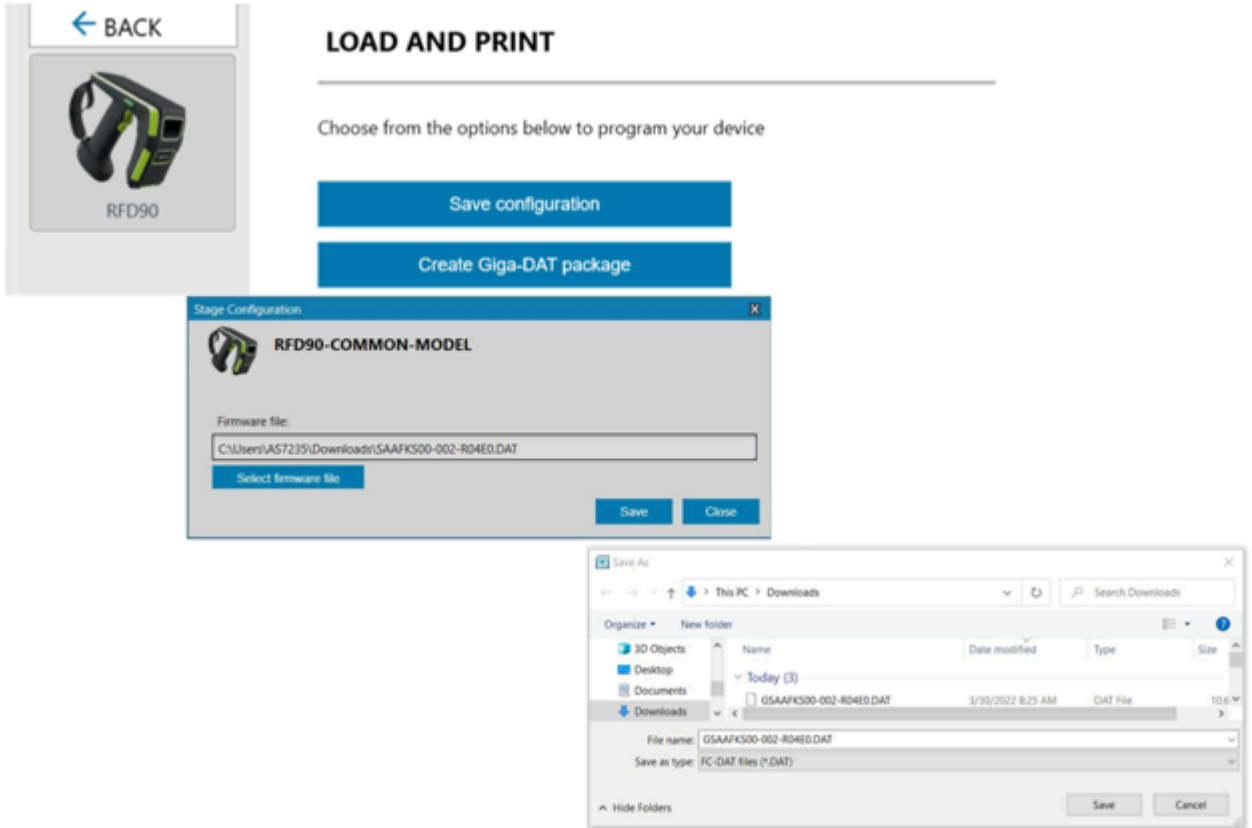

The Stage Configuration window updates to indicate that the new Giga-DAT File is successfully saved.

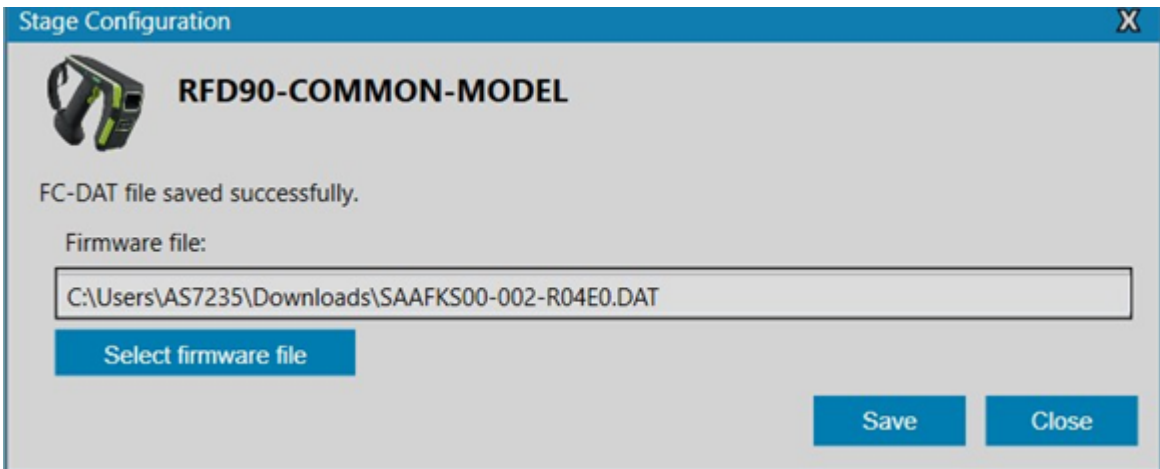

Maintenance

This chapter provides suggested sled maintenance, troubleshooting, and technical specifications.



CAUTION: Always wear eye protection. Read warning label on compressed air and alcohol product before using. If you have to use any other solution for medical reasons please contact Zebra for more information.



WARNING: Avoid exposing this product to contact with hot oil or other flammable liquids. If such exposure occurs, unplug the device and clean the product immediately in accordance with these guidelines.



IMPORTANT: Use pre-moistened wipes and do not allow liquid cleaner to pool. Ensure the following items are addressed when using sodium hypochlorite (bleach) based cleaners:

- For device only. Do not use on cradle.
- Always follow the manufacturer's recommended instructions: use gloves during application and remove the residue afterwards with a damp cloth to avoid prolonged skin contact while handling the device.
- Due to the powerful oxidizing nature of sodium hypochlorite, the metal surfaces, including electrical contacts on the device, are prone to oxidation (corrosion) when exposed to this chemical in the liquid form (including wipes) and should be avoided. In the event that these type of disinfectants come in contact with metal on the device, prompt removal with a dampened cloth after the cleaning step is critical.



IMPORTANT: To avoid damage to the device, use only approved cleaning and disinfecting agents listed below. The use of non-approved cleaning or disinfecting agents may void the warranty.

Harmful Ingredients

The following chemicals are known to damage the plastics on Zebra devices and should not come in contact with the device:

- Acetone
- Ammonia solutions
- Aqueous or alcoholic alkaline solutions
- Aromatic and chlorinated hydrocarbons
- Benzene

- Carbolic acid
- Compounds of amines or ammonia
- Ethanolamine
- Ethers
- Ketones
- TB-lysoform
- Toluene
- Trichloroethylene.

Tolerable Industrial Fluids and Chemicals

The following industrial fluids and chemicals were evaluated and deemed tolerable for the RFD90 RFID sled:

- Motor/Engine Oil
- Automatic Transmission Fluid (ATF)
- Continuously Variable Transmission Fluid (CVT)
- Industrial De-Greaser (Engine Brite Heavy Duty)

Cleaning the Sled

Routinely cleaning the exit window is required. A dirty window may affect scanning accuracy. Do not allow any abrasive material to touch the window.

To clean the device:

1. Dampen a soft cloth with one of the approved cleaning agents listed above or use pre-moistened wipes.
2. Gently wipe all surfaces, including the front, back, sides, top and bottom. Never apply liquid directly to the device. Be careful not to let liquid pool around the device window, trigger, cable connector or any other area on the device.
3. Be sure to clean the trigger and in between the trigger and the housing (use a cotton-tipped applicator to reach tight or inaccessible areas).
4. Do not spray water or other cleaning liquids directly into the exit window.
5. Wipe the device exit window with a lens tissue or other material suitable for cleaning optical material such as eyeglasses.
6. Immediately dry the device window after cleaning with a soft non-abrasive cloth to prevent streaking.
7. Allow the unit to air dry before use.

8. Connectors:

- Dip the cotton portion of a cotton-tipped applicator in isopropyl alcohol.
- Rub the cotton portion of the cotton-tipped applicator back-and-forth across the connector on the Zebra sled at least 3 times. Do not leave any cotton residue on the connector.
- Use the cotton-tipped applicator dipped in alcohol to remove any grease and dirt near the connector area.
- Use a dry cotton tipped applicator and rub the cotton portion of the cotton-tipped applicator back-and-forth across the connectors at least 3 times. Do not leave any cotton residue on the connectors.

Technical Specifications

The following table outlines the physical characteristics and user environment of the RFD90 UHF Ultra-Rugged RFID sled.

Table 12 RFD90 UHF Ultra-Rugged RFID

Item	Description
Physical Characteristics	
Dimensions	RFD9030: 189 x 83.4 x 173 mm /7.4 x 3.2 x 6.8 in RFD9090: 248 x 96.3 x 173 mm/9.8 x 3.8 x 6.8 in.
Weight	RFD9030 with SE4750MR: 25 oz./714 grams RFD9030 with SE4850: 26.5 oz./751 grams RFD9090 with SE4750MR: 26.8 oz./759 grams RFD9090 with SE4850: 28.2 oz./799 grams
Power	Quick-Release, PowerPrecision+ 7000 mAh Li-Ion battery
Frequency Range/RF Output	US: 902-928 MHz; 0 - 30 dBm (EIRP) EU: 865-868 MHz; 0 - 30 dBm (EIRP) 916.3, 917.5, and 918.7 MHz; 0–30 dBm (EIRP) Japan: 916-921 MHz (w LBT); 0 - 30 dBm (EIRP)
User Environment	
Operating Temperature	-20°C to 55°C (-4°F to 131°F)
Storage Temperature	-40°C to 70°C (-40°F to 158°F)
Charging Temperature	0°C to 40°C (32°F to 104°F)
Relative Humidity	Operating: 5 to 85% non-condensing
Sealing	IP65 (spray) and IP67 (submersion)
Drop Specification	Multiple 6 ft./1.8 m drops to concrete
Tumble Specification	500 cycles (1,000 drops, 1.6 ft./0.5 m) at room temperature
Electrostatic Discharge	± 15 kV air discharge ± 8 kV direct discharge ± 8 kV indirect discharge

Troubleshooting

The table below outlines possible troubleshooting cases that may occur when using the sled related to data communication, barcode decode, and Bluetooth.

Table 13 Troubleshooting the RFD90

Problem	Cause	Solution
The RFID sled does not read tags.	The RF region configuration is not set.	Use the 123RFID Desktop or 123RFID Mobile application to set the regulatory region or country operation per the application instructions.
The RFID sled is attached to a mobile device and it is not responsive to a RFID application, even after the trigger is pressed.	The battery is too low and not able to power the RFID sled.	Press the trigger for a couple of seconds to power the RFID sled On. The RFID sled LED blinks amber when it is turned On. (By default, pressing the trigger turns On the RFID sled if it is in Off mode. However, the RFID sled can be disabled in which case this step is not necessary.) Place the RFID sled in the charging cradle. The RFID sled blinks amber LEDs indicating charging commenced.
	Zebra supported mobile computer is not properly inserted in the RFID Sled.	Reinsert the Zebra supported mobile device securely in the RFID sled and ensure that the USB cable is correctly inserted.
	Damaged battery.	If the sled LED does not blink amber after sitting on the charging cradle for a while, request service to replace the battery.
The sled is responsive but cannot read tags.	Battery is critically low.	Place the RFID sled in the charging cradle. The RFID Sled LED blinks amber. The RFID sled can be used when its LED turns on momentarily amber or green upon removal from the charging cradle.

Table 13 Troubleshooting the RFD90 (Continued)

Problem	Cause	Solution
The sled LED blinks fast amber when in the cradle.	Charging error.	Restart charging by removing the RFID sled from the cradle and inserting it back in the cradle. If the issue persists, request service to replace the battery.
The sled LED blinks red, or LED blinks red alternating with green or amber while in use (not while charging).	Battery end of life indication.	Request service to replace the battery.
Zebra supported mobile computer battery is not charging.	Charging cradle was unplugged from AC power.	Ensure the charging cradle is receiving power.
	The Zebra supported mobile computer is not fully seated in the cradle.	Remove and re-insert the zebra supported mobile computer into the cradle, ensuring it is firmly seated in the charging cradle.
Data Communication		
During data communication with a host computer, no data transmitted, or transmitted data was incomplete.	Sled removed from cradle during communication.	Replace the sled in the cradle and re-transmit.
	Incorrect cable configuration.	See the system administrator.
	Communication software was incorrectly installed or configured.	Perform setup.
During data communication over Bluetooth, no data transmitted, or transmitted data was incomplete.	Bluetooth radio is not on.	Turn on the Bluetooth radio.
	The sled moved out of range of another Bluetooth device.	Move within 10 meters (32.8 feet) of the other device.
Decode		
The sled does not decode with a reading barcode.	The scanning application is not loaded.	Load 123RFID Mobile on the device or 123RFID Desktop on the PC. See the system administrator.
	Unreadable barcode.	Ensure the symbol is not defaced.
	The distance between the exit window and the barcode is incorrect.	Place the device within proper scanning range.
	The device is not programmed to generate a beep.	If the sled does not beep on a good decode, set the application to generate a beep on good decode.
	The battery is low.	If the sled stops emitting a laser beam upon a trigger press, check the battery level. When the battery is low, the sled shuts off before the low battery condition notification.
Bluetooth		

Table 13 Troubleshooting the RFD90 (Continued)

Problem	Cause	Solution
The device cannot find any Bluetooth devices nearby.	Too far from other Bluetooth devices.	Move closer to the other Bluetooth device(s), within a range of 10 meters (32.8 feet).
	The Bluetooth device(s) nearby are not turned on.	Turn on the Bluetooth device(s) to find.
	The Bluetooth device(s) are not in discoverable mode.	Set the Bluetooth device(s) to discoverable mode.

