

BIXOLON®

Users' Manual

STP-103III

Thermal Printer

Rev. 1.02

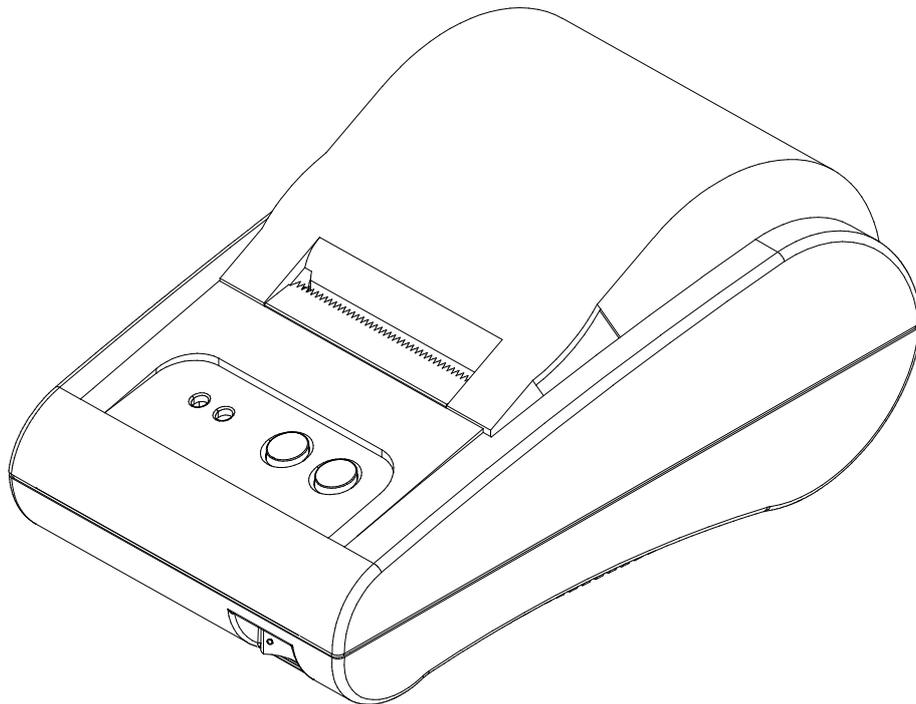

<http://www.bixolon.com>

■ Safety Precautions

The instructions shown below must be followed to prevent possible danger or damage by using the product incorrectly.



Warning

Serious injury or death may result if the instructions associated with this sign are not followed.

Do not plug in multiple products into one outlet at the same time.

- It could result in overheating or fire.
- If dirt or moisture enter the power plug, clean it thoroughly before using it.
- If the power receptacle is loose, do not connect in the power plug.
- Use only standard multi-outlets.

PROHIBIT

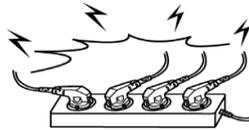

Use only the adaptor supplied with the product.

- Using other adaptors is dangerous.

PROHIBIT



Do not pull the cable to unplug the power plug.

- Power cord may get damaged, which could cause faults or fire.

PROHIBIT

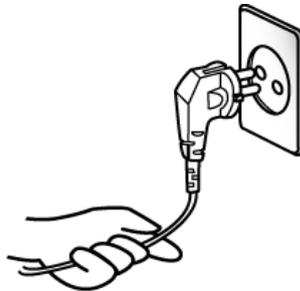

Keep the vinyl pack out of reach of children.

- It is dangerous to children.

PROHIBIT



Do not plug or unplug the power plug with wet hands.

- It could cause an electric shock.

PROHIBIT

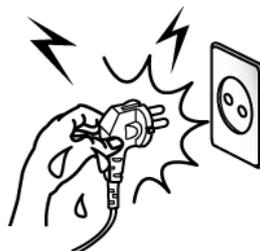

Do not apply excessive force to bend the cable and do not place heavy objects on the cable.

- It could cause a fire.

PROHIBIT

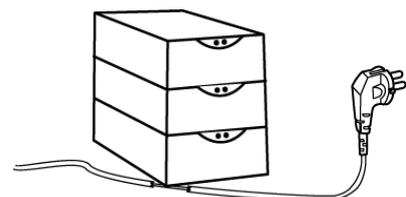



Caution

Minor injury or product damage may result if the instructions associated with this sign are not followed.

If smoke, strange smells or noises come from the product, turn off the power immediately and follow the instructions below.

- If the product is not working normally, turn off the power to the printer main body immediately and unplug the power cord from the outlet.
- After checking that there is no smoke, request repair from where you purchased the product.

PROHIBIT

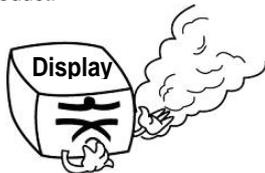

Keep the desiccant out of the reach of children.

- It is dangerous if children eat it.

PROHIBIT



Install the product in a stable place.

- Product may be damaged or it could cause an injury if it falls over.

PROHIBIT

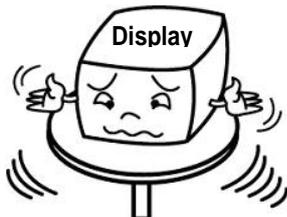

Use only approved parts, and avoid unauthorized disassembly, repair, or modification.

- Contact the sales representative as unauthorized service may damage the product.
- Do not touch the blade of the auto cutter as it is sharp.

DISASSEMBLING PROHIBITED

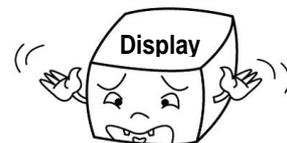

Take care not to let water or dirt get inside the main body of the printer.

- When water or dirt penetrated the main body, turn off the power to the printer main body first, unplug the power cord, and contact the sales representative.

PROHIBIT

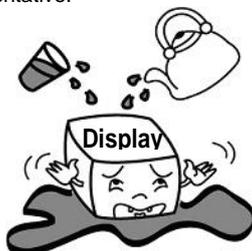

Do not use the product if it is malfunctioning. It could cause fire or electric shock.

- Turn off the power to printer main body immediately, unplug the power cord, and contact the sale representative.

TO UNPLUG



**(C) Copyright BIXOLON Co., Ltd.
All rights reserved**

This users' manual and the product are protected by copyright laws.

The users' manual or the product shall not be copied, replicated, translated, or transformed into a form that is readable by electronic media or machines either partially or fully without the prior written consent of BIXOLON. This users' manual may contain errors in printing or technical errors, and they are subject to change without prior notice.

STP-103III and the logo of BIXOLON are registered trademarks of BIXOLON.

This device is registered as electromagnetic wave compliant equipment suitable for business purposes, and users or sellers need to take precautions. If the product is purchased or sold improperly, exchange the product for one for home use.

We make continuous improvements in order to enhance the functions and quality of the products.

The specifications of the products and the contents of the manual are subject to change without prior notice for this reason.

■ WEEE (Waste Electrical and Electric Equipment)



The marks on this product and related descriptions mean that the product shall not be disposed of together with other home use wastes when the product reaches the end of its life. In order to prevent damage to the environment and people caused by mixing this product with other wastes, separate it from other wastes. Your cooperation for saving resources following the recycling policy would be appreciated. Home users can contact the sales representative where the product was purchased or local government offices to check the disposal method and places. Business users can contact the supplier or read the conditions in the purchase contracts. The product must not be mixed with other commercial-use wastes.

■ Rating Label Symbol Information



DC (Direct current)

■ Label Material: PET

■ Product Overview*** Parts Name**

- (1) Top cover
- (2) Front face of case
- (3) Bottom of case
- (4) Control panel
- (5) Power switch
- (6) Roller
- (7) Communication connector
- (8) USB
- (9) DK terminals
- (10) Power terminals
- (11) Paper
- (12) Detection switch

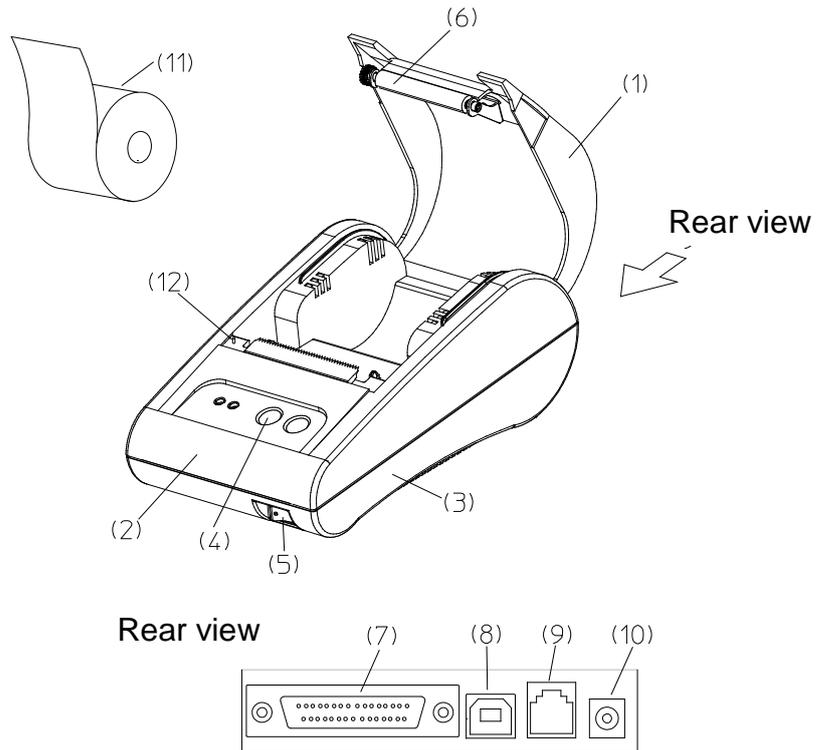

The STP-103III roll printer is designed to be used with other electric devices such as banking devices and peripheral devices, ECR, and POS.

Main features are as follows.

1. Fast printing speed
2. Low noise thermal printing
3. RS-232 serial interface and parallel interface
4. Data can be received through the data buffer while printing.
5. Printing density can be selected using DIP switches.

Read the instructions in this manual carefully before using the STP-103III.

※ Caution

Electric wall outlet must be conveniently located near to the device and easily accessible.

■ Table of Contents

1. Installation and Basic Instructions of the Printer7
1-1 Unpacking.....7
1-2 Installation Location7
1-3 Operation Control Panel8

2. Connecting Cable9
2-1 Connecting AC Adapter9
2-2 Connecting Interface Cable10
 2-2-1 Serial Interface of STP-103III11
 2-2-2 Parallel Interface of STP-103III.....11
 2-2-3 USB Interface of STP-103III12

3. DIP Switches Setting13

4. Installing Paper Roll15

5. Self Test.....16
5-1 Self Test Printing16
5-2 Finishing Self Test16

6. Hexadecimal Dumping17

7. Specifications18

1. Installation and Basic Instructions of the Printer

1-1 Unpacking

Check the following contents and contact the sales representative where you purchased the product if any item is missing or incorrect.

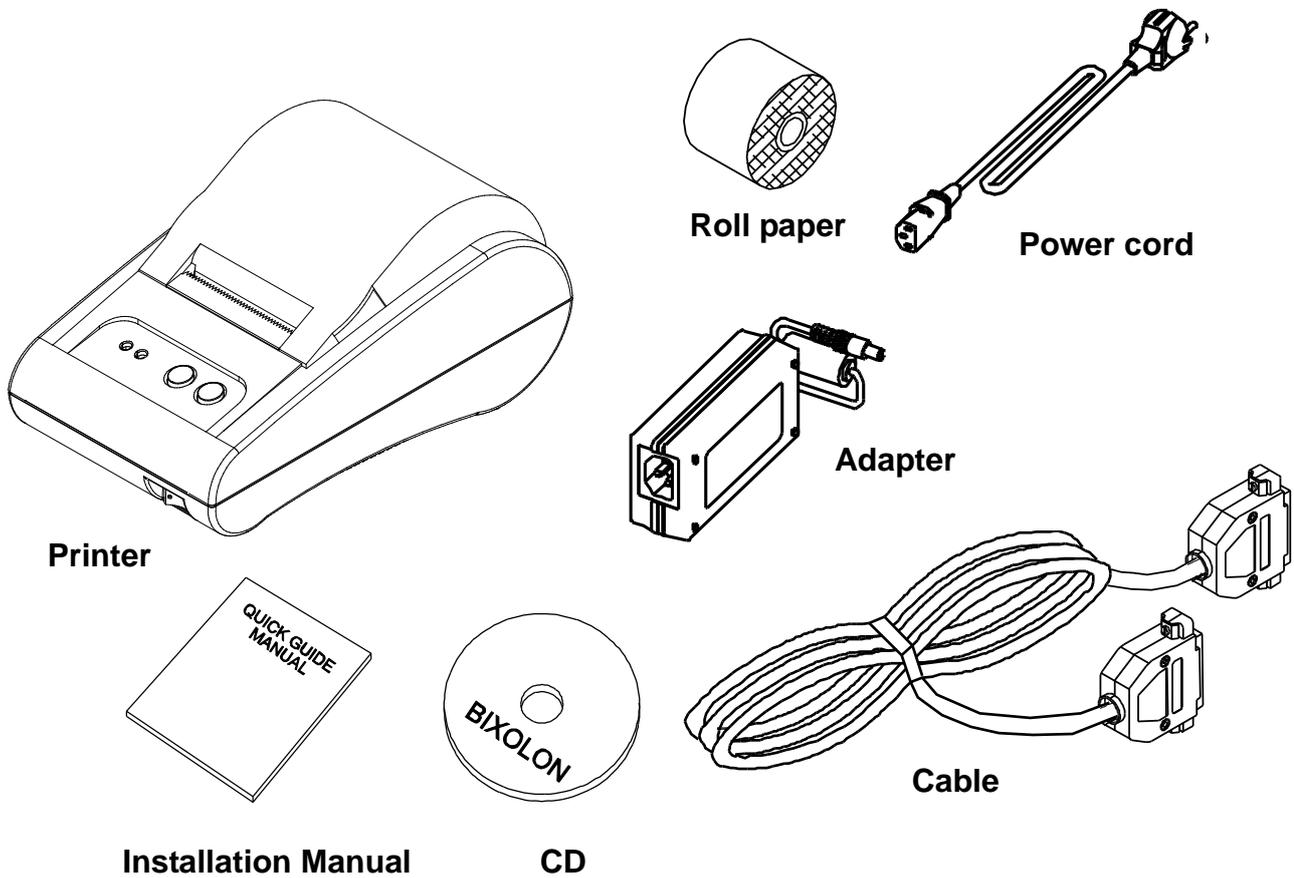

1-2 Installation Location

Avoid installing near heat or in direct sunlight.

Avoid humid places.

Store and use the product on a flat area and avoid locations where it may be banged.

Secure enough space around the printer so that it can be used easily.

1-3 Operation Control Panel

There are two buttons and two lights on the control panel.

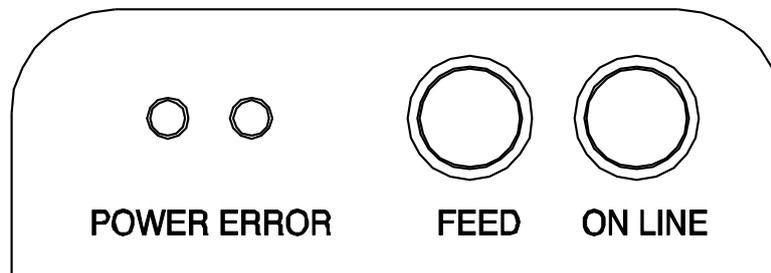
**Buttons**

Buttons are for paper feed and online functions.

ON LINE

Press ON LINE button to receive data from the computer.

FEED

Press the FEED button to print one line.

Press and hold the feed button to print continuously.

FEED button can be used when ON LINE button is off.

Lights

Lights indicate the status of the printer.

POWER (green)

This light is on when the printer is turned on.

ERROR (red)

This light blinks when there is no paper.

This light also blinks when near-end-sensor is activated.

2. Connecting Cable

2-1 Connecting AC Adapter

Use the optional AC adapter for the printer.

※ **Warning**

Using an improper power supply device could cause fire or electric fault.

※ **Caution**

Check that the power supply device is connected to the power terminal when turning the printer on or off. Otherwise, it may damage the printer or the power supply device.

2-1-1 Check whether the power switch of the printer is off and whether the power supply device is disconnected from the power terminal.

2-1-2 Check that the supply voltage is correct for the device.

2-1-3 Connect the DC cable connector of the power supply device to the power connector of the printer as shown below.

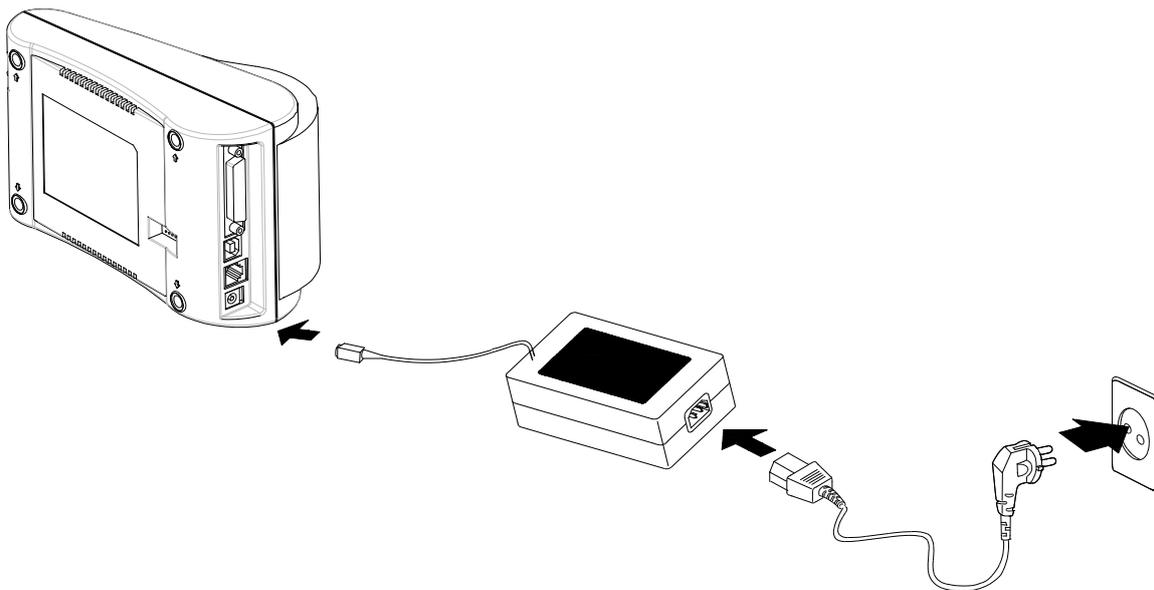

2-1-4 Connect the power cord of the AD adapter to the power terminal of the printer.

※ **Caution**

When you remove the DC cable connector, hold the connector tightly in the direction of the arrow and pull the cable horizontally. Make sure that the power cord is not connected on the power supply side.

2-2 Connecting Interface Cable

In order to connect the printer to the computer, you need a proper serial, parallel, or USB interface cable.

- Check that both computer and printer are turned off, and connect the cable connector to the interface connector of the printer.
- Fasten the screws on both sides of the cable connector.
- Connect the other end of the cable to the computer.

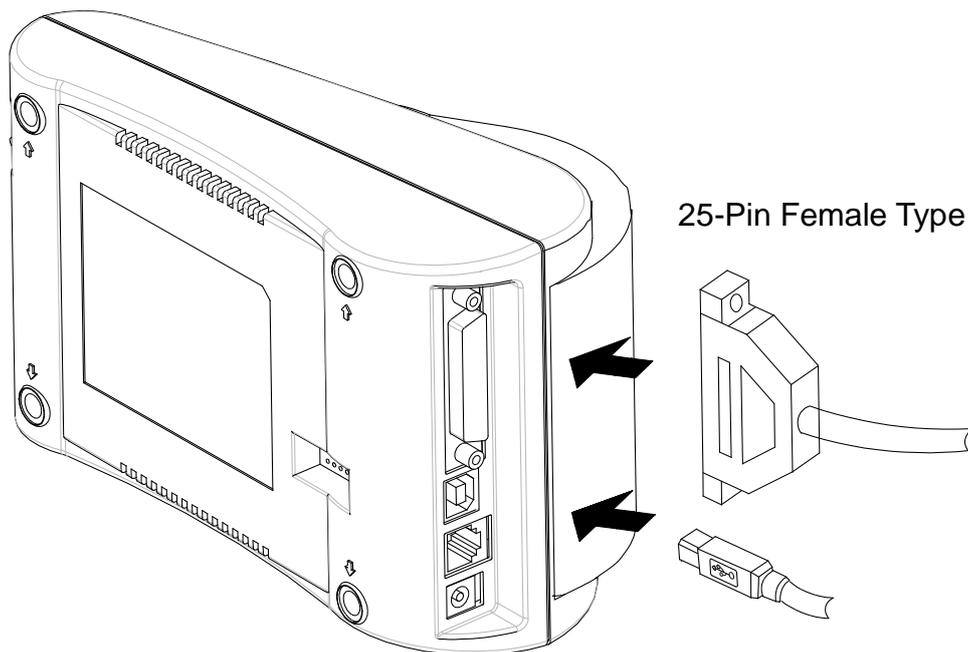

2-2-1 Serial Interface of STP-103III

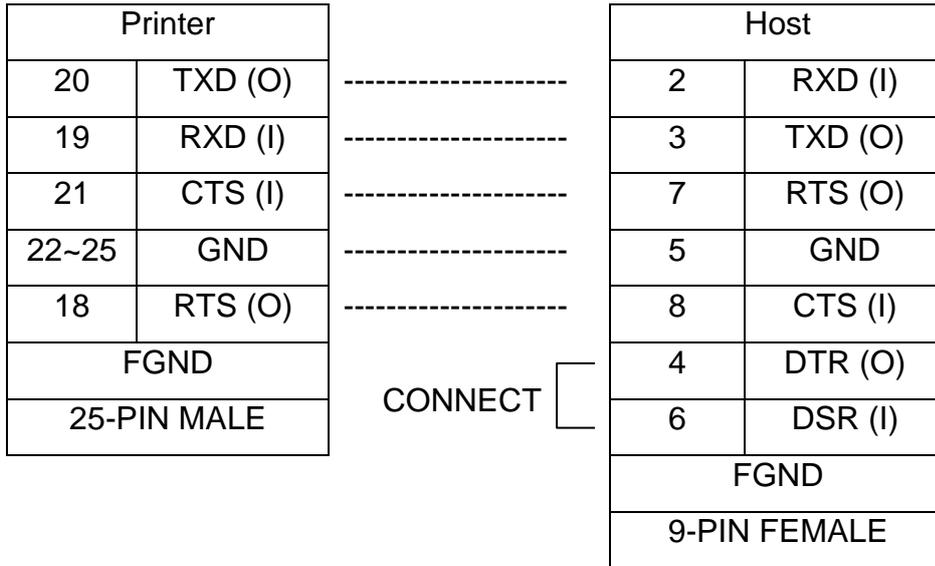

2-2-2 Parallel Interface of STP-103III



2-2-3 USB Interface of STP-103III

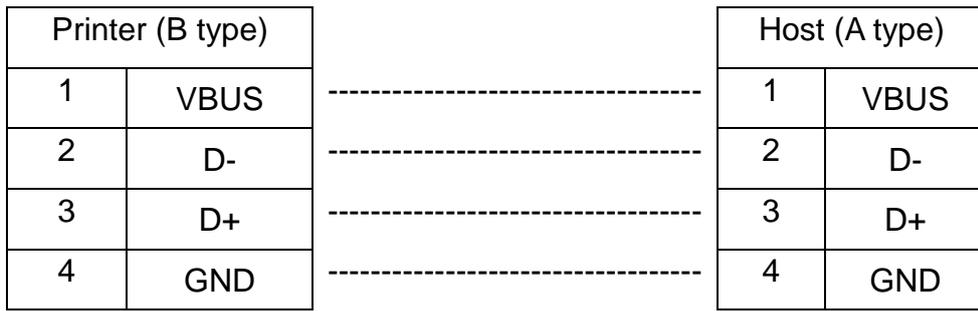

3. DIP Switches Setting

※ **Caution**

The printer must be turned off while setting the DIP switches in order to prevent electric short failures or other damage to the printer.

Changes to connection device and printing density are configured with DIP switches

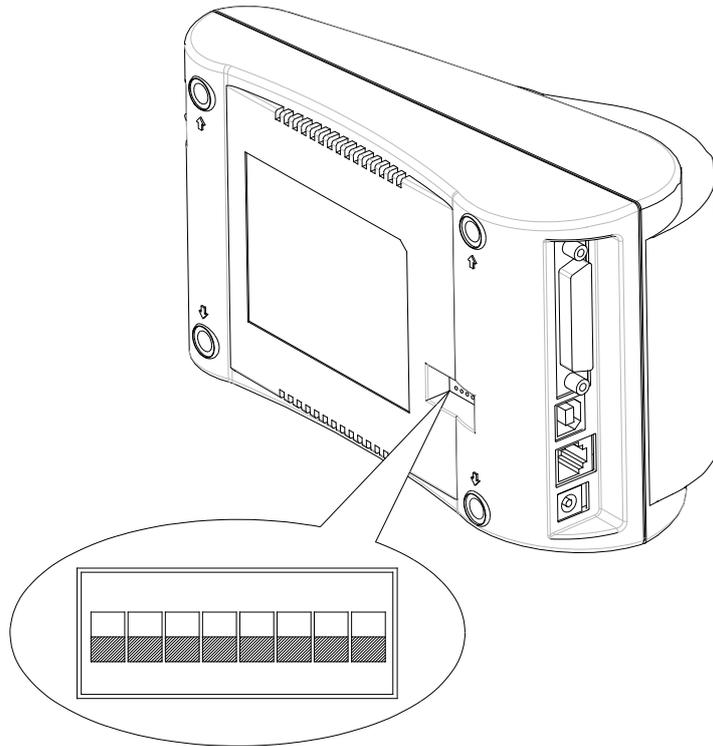

3-1 Make sure that the printer is turned off.

3-2 Note that 'ON' position is marked for each switch, and use tweezers or sharp objects to change the switch settings.

※ **Attention**

The printer must be turned off when changing the DIP switch settings. Failure to turn it off may cause a short circuit and damage the printer.

To change the settings:

- 1) Turn off the printer.
- 2) Open the DIP switch cover located at the back of the printer.
- 3) Set the DIP switch number.
- 4) Close the DIP switch cover after the settings have been completed.
- 5) Position the printer in front and turn it on.

※ **Note**

Please make sure that the printer is turned off when changing the DIP switch settings. The change is not accepted when the power is on.

3-3 Refer to the following table for switch settings

SW	Function	ON	OFF	Default
SW 1-1	Baud Rate Selection	* Refer to the Following Table 1		OFF
SW 1-2				OFF
SW 1-3				ON
SW 1-4	Density	Dark	Normal	OFF
SW 1-5	Handshaking	Xon / Xoff	DTR/DSR	OFF
SW 1-6	Character per Line (Font A)	24 CPL	32 CPL	OFF
SW 1-7	Font Select	* Refer to the Following Table 2		OFF
SW 1-8				OFF

[Table 1 Baud rate setting]

Transmission Speed	SW 1-1	SW 1-2	SW 1-3	Remark
2400 Baud	ON	OFF	OFF	
4800 Baud	OFF	ON	OFF	
9600 Baud	OFF	OFF	ON	Default
19200 Baud	ON	OFF	ON	
38400 Baud	ON	ON	OFF	
57600 Baud	OFF	ON	ON	
115200 Baud	ON	ON	ON	

[Table 2 Font selection]

Font size	SW 1-7	SW 1-8	Remark
Font A 12x24	OFF	OFF	Default
Font B 9x17	ON	OFF	
Font C 9x24	OFF	ON	
Reserved	ON	ON	

4. Installing Paper Roll

Use the specified paper.

※ **Caution**

The printer must be turned off when installing paper.

4-1 Open the printer cover and pull out and remove the completed used roll.

4-2 When installing the roll, insert it in the correct direction as shown in the picture.

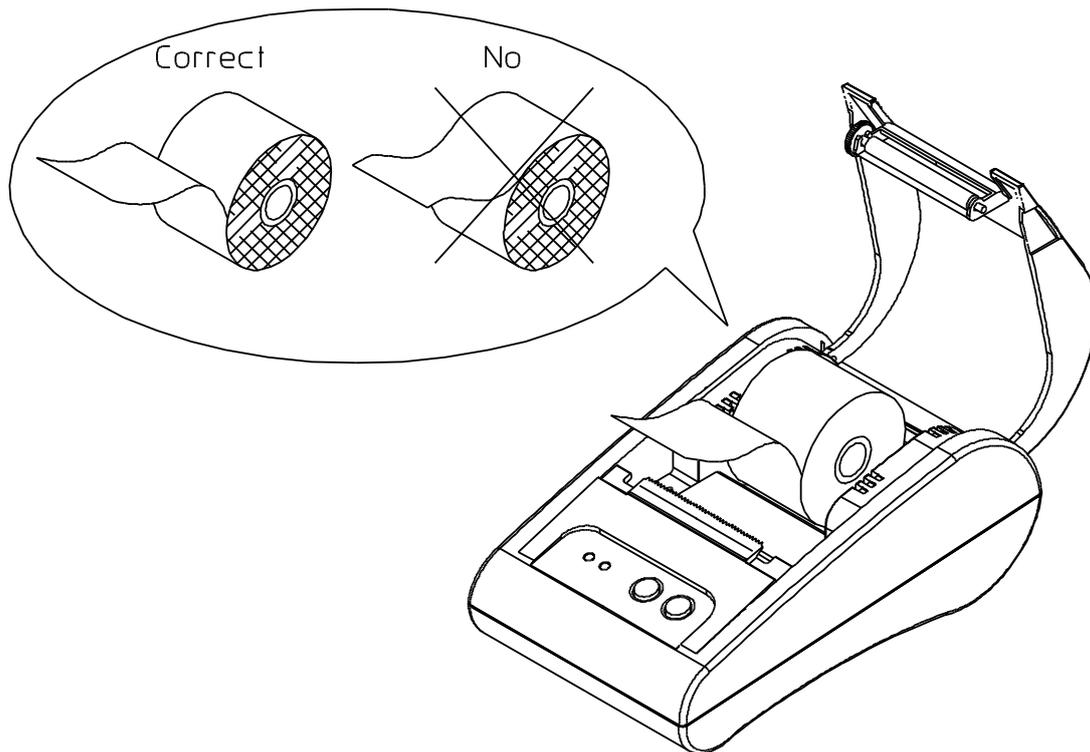

4-3 Pull the roll so that the paper is pulled out of the upper part of the printer and close the printer cover.

4-4 Turn on the printer

5. Self Test

5-1 Self Test Printing

* Starting the self test

Mount the roll, close the cover, and turn on the printer while pressing the PAPER FEED button to start the self test.

The self test printing will print the current settings of the printer including the following information.

- Software version control
- DIP switch setting

* Preparation state

After printing the current status of the printer, the printer prints the message "Please press the FEED BUTTON". The LED blinks and the printer enters the test print preparation mode.

5-2 Finishing Self Test

After the test printing is completed, the printer notifies the end of test printing by printing the " ** COMPLETED ** " message.

If the self test is not completed, reboot the printer.

6. Hexadecimal Dumping

This function allows accurate checking of the exchanged data of the printer for advanced users so that software issues can be identified. As all data and commands are printed in hexadecimal when using hexadecimal dumping function, it is helpful to find special commands.

Follow the steps below to use the hexadecimal dumping function.

6-1 Turn off the printer and close the printer cover.

6-2 Hold down the FEED button ONLINE button at the same time and turn off the printer.

6-3 The printer enters the hexadecimal dumping mode.

6-4 Execute the program to send the data to the printer.

The printer prints all data divided into two rows.

The first row shows the hexadecimal code and the second row shows the corresponding ASCII character.

1B	21	00	1B	26	02	40	40	.!	.&	.@	@
1B	25	01	1B	63	34	00	1B	.	%	.c	4.
41	42	43	44	45	46	47	48	ABCDEFGH			

- When there is no corresponding ASCII code, the period (.) will be printed.
- During the hexadecimal dumping mode, all commands except **DEL EOT** and **DLE ENQ** cannot be used.

6-5 Turn off the printer to end the hexadecimal dumping mode.

6-6 The hexadecimal dumping mode is cleared when the printer is turned on again.

7. Specifications

Printing method	Thermal line printing	
Dot pitch	203Dpi (8 dot/mm)	
Printing width	48mm	
Paper width	57.5±0.5mm	
Characters per line	32 (Font A) (12x24) 42 (Font B) (9x17) 42 (Font C) (9x24)	
Printing speed	About 3.15 inches/sec 80 mm/sec at 25 °C/printing duty 12.5%	
Paper	Thickness of the used paper: 0.062 ~ 0.075mm	
	Diameter of the paper roll: Ø60mm	
	Paper roll size - Inner diameter: Ø12mm (0.47") - Outer diameter: Ø18mm (0.71")	
Buffer size	64K bytes	
SMPS supply voltage	100~240 VAC	
Conditions	Temperature	0 ~ 45°C (operating) -20 ~ 60°C (storage)
	Humidity	10 ~ 80% RH (operating) 10 ~ 90% RH (storage)
MCBF	Mechanism	30,000,000 line
	Head	50km

- This equipment is indooruse and all the communication hiring are limited to inside of the building.

- The switch is the disconnecting device. Turn off switch from any hazard.