

**BIXOLON®**

**User's Manual**

# **Network Interface**

---

**Rev. 1.00**

**SRP-350plusIII**

**SRP-352plusIII**



<http://www.bixolon.com>

## ■ Table of Contents

<b>1. Manual Information</b> .....	<b>3</b>
<b>2. Precautions</b> .....	<b>3</b>
<b>3. Specifications</b> .....	<b>4</b>
<b>4. How to Connect</b> .....	<b>5</b>
4-1 Initial WLAN Connection (Windows 2000) .....	8
4-2 Initial WLAN Connection (Windows XP) .....	8
4-3 Initial WLAN Connection (Windows VISTA, Windows 7, Windows 8).....	13
<b>5. Configuration</b> .....	<b>19</b>
5-1 WLAN Setting: FTP .....	21
5-2 WLAN Setting: Telnet .....	23
<b>6. Ethernet/WLAN Test by using Windows Test Page</b> .....	<b>24</b>
<b>7. Factory Reset</b> .....	<b>30</b>
7-1 Initializing LAN Settings .....	30
7-2 Initializing WLAN Settings.....	31
<b>8. Troubleshooting</b> .....	<b>33</b>

### **1. Manual Information**

This Network manual provides information on the connection of network with the printer.

We at BIXOLON maintain ongoing efforts to enhance and upgrade the functions and quality of all our products. In following, product specifications and/or user manual content may be changed without prior notice.

### **2. Precautions**

2-1 The printer has to be within 100m (Outdoor) from AP (Access point) to connect WLAN. Although 35m is able to communicate in door, WLAN could be affected by environment to be shorten.

2-2 The maximum separating distance may be shortened if transmission obstacles, such as cement walls, are present

2-3 If a device (such as a microwave oven, wireless LAN, etc.) that uses the same frequency is present, transmission may be interrupted. Separate the printer and Bluetooth-enabled device from such interrupting devices by a distance of at least 5m.

### 3. Specifications

CATEGORIES	FEATURE	IMPLEMENTATION	
WLAN Specification	Standard	IEEE802.11b, IEEE802.11g, IEEE802.11n	
	Frequency Range	2.412~2.484GHz	
	Channels	1 ~ 14 channels	
	Range	Up to 100m free space (Outdoor)	
	Connection Modes	Infrastructure and Ad-hoc (IBSS), Wi-Fi Direct	
	Security	Open Connection	
		Shared Key(WEP encryption 64 and 128 bit options)	
WPA-PSK, WPA2-PSK			
WPA1/2 Enterprise (EAP-TLS, EAP-TTLS, PEAP, LEAP, FAST)			
SSL2 / SSL3 / TLS1			
Protocol	DHCP Client, HTTP, HTTPS, TELNET, FTP, ARP, ICMP, SNMP, IPv4, TCP, UDP		
LAN Specification	Interface	10/100 Base-T All in one (Auto detection)	
	Protocol	DHCP Client, HTTP, ARP, ICMP, IPv4 ,TCP, UDP	

## 4. How to Connect

### (1) Connecting WLAN Printer

Connect to the AP (Access Point) configured in Infrastructure mode in order to connect to the wireless network

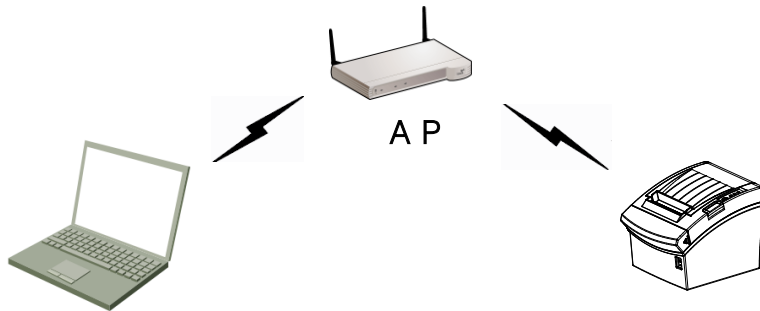

Infrastructure mode

In order to configure the network between wireless terminals, connect to the terminal in Ad-hoc / Wi-Fi Direct Mode.



Ad-hoc / Wi-Fi Direct mode

## Network Interface

### (2) Checking Network Setting

#### 1) LAN

Function key

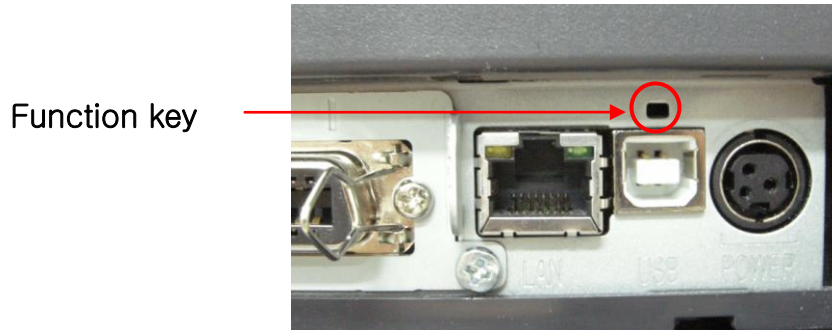

- a. Turn on the printer.
- b. Wait 10 or more seconds until the LAN interface boots up.
- c. Push the function key.
- d. The settings will be printed only one time since the printer is turned on.

#### 2) WLAN

- a. Turn on the printer and wait for about 10 seconds until WLAN interface boots up.  
The Error/Paper LED will stop blinking when booting is complete.

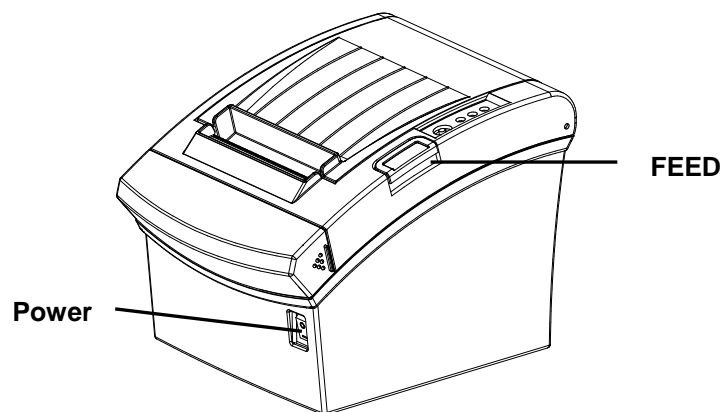

- b. When booting process is complete, open the printer cover and press the FEED button for five seconds. The internal buzzer will sound five times and printer will be in WLAN selection mode. Mount the paper properly, close the cover, and check that the following information is printed.

## Network Interface

### WLAN Mode Selection

#### Modes

- 0: Exit
- 1: WLAN Information Print
- 2: WLAN Factory Reset  
and Reboot Printer.
- 3 or more: None

Select Modes by Feed button control  
as below.

Step 1. Short-press as many times as  
The mode number to choose.

Step 2. Long-press over 1 second.

\*e.g. To choose Mode 2, press Feed

Button 3 times(short-short-long)

- c. When the above message is printed, you can print and check the WLAN information as shown below by selecting Mode 1. (Mode 1 can be selected by one short-press of the Feed button followed by one long-press.)

```
WLAN F/W VERSION : 0.1
SYSTEM NAME : SRP-350plusIII
NETWORK MODE : ADHOC
ENCRYTION : NONE
ESSID : PRINTER_adhoc
DHCP : ENABLED
IP ADDRESS : 192.168.1.1
SUBNET MASK : 255.255.255.0
GATEWAY : 192.168.1.2
PORT : 9100
HTTPS : DISABLED
TELNET : DISABLED
FTP : DISABLED
SNMP : DISABLED
WLAN MACADDRESS
```



C C 7 A 0 0 0 0 1 0 8 7 7

## 4-1 Initial WLAN Connection (Windows 2000)

Windows 2000 does not support wireless network setting.

When you use Windows 2000, you need to set the utility option as below after installing utility program related to the wireless LAN driver that you use.

- Network mode: Ad-hoc
- SSID: PRINTER\_adhoc
- IP address: 192.168.1.2
- Subnet Mask: 255.255.255.0
- Authentication (Encryption): Open (None)

## 4-2 Initial WLAN Connection (Windows XP)

When wireless utility program is installed, you have to set the wireless control values via the program, otherwise you have to terminate the program in order to do proper setting after following the steps 'Control Panel>>Administrative tools>>Services>>Wireless Zero Configuration>>Start'.



1) Right click on the  icon, and select Properties.

2) Select and right click on the Wireless Network Connection, and then select Properties.

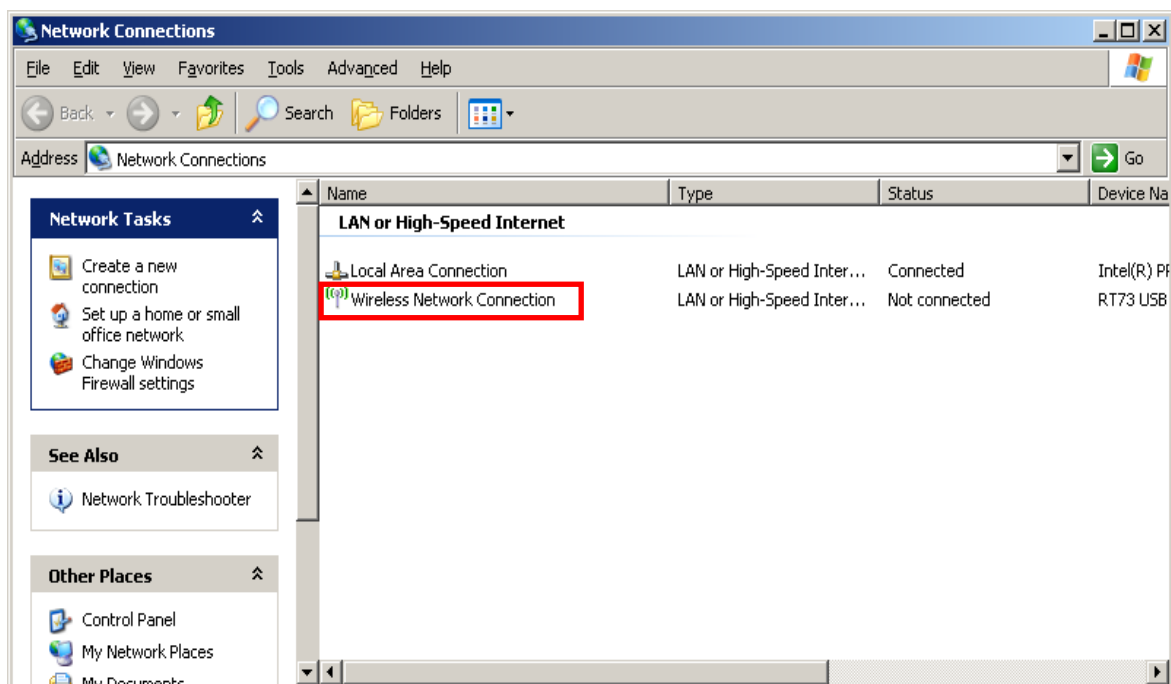



## Network Interface

3) Select Internet Protocol (TCP/IP), and then click Properties.

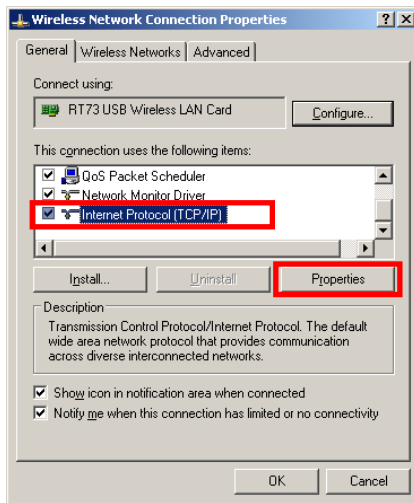

4) Set the IP settings as shown below, and then click OK.

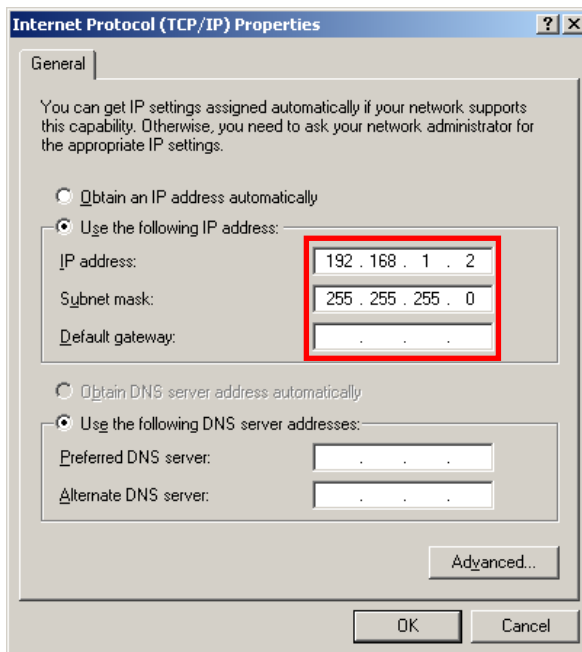

## Network Interface

- 5) Select the Wireless LAN tab, and then select “Use Windows to configure my wireless network settings.”

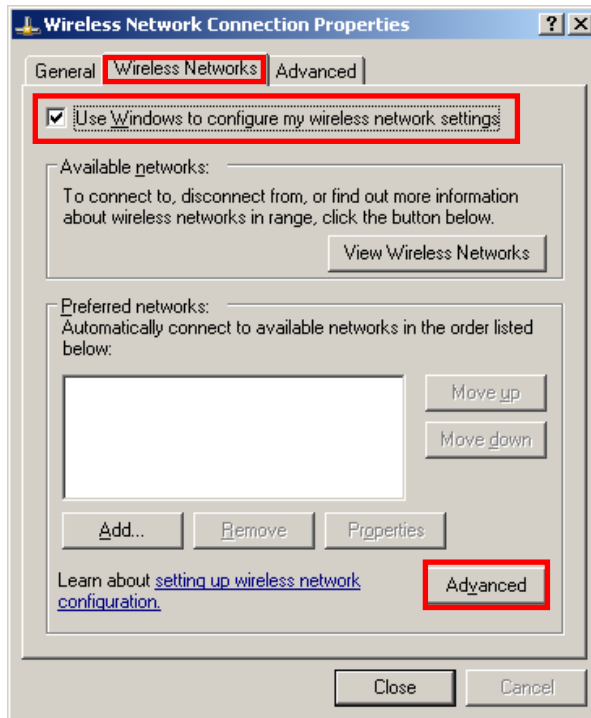

Click the [Advanced] button.

- 6) Select “Computer-to-computer (ad hoc) network only.”

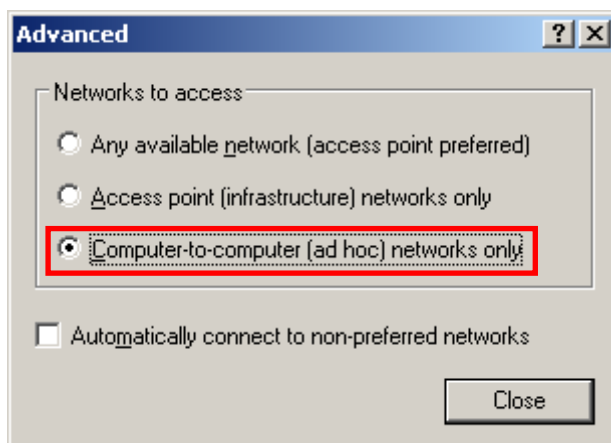

7) Click the [Add] button.

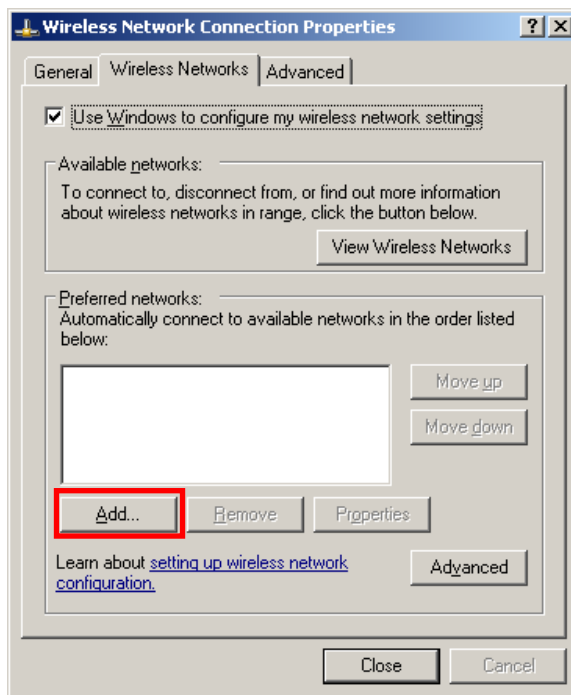

8) Enter "PRINTER\_adhoc" as the Network name (SSID).  
Select the connection, even if the network is not broadcasted.  
Network Authentication: Select [Open]  
Data Encryption: Select [Disabled]

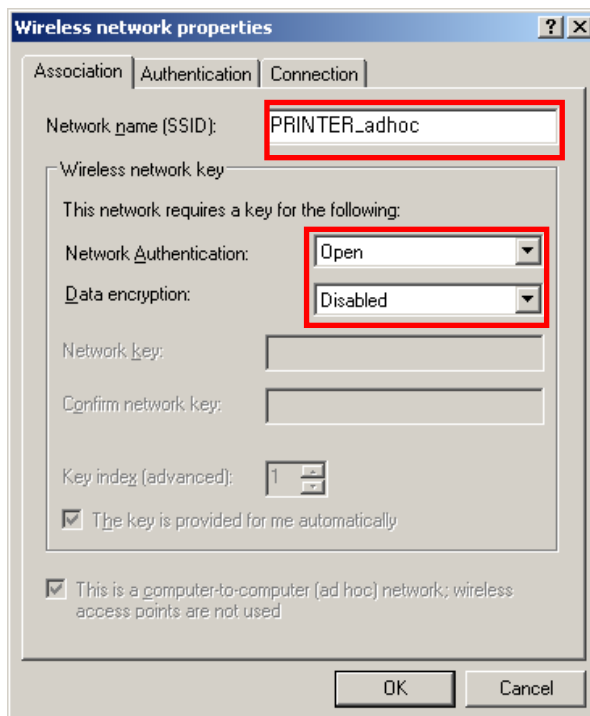

Click the [OK] button.

## Network Interface

9) Click the “Connect” tab and check “Connect when this network is in range.”

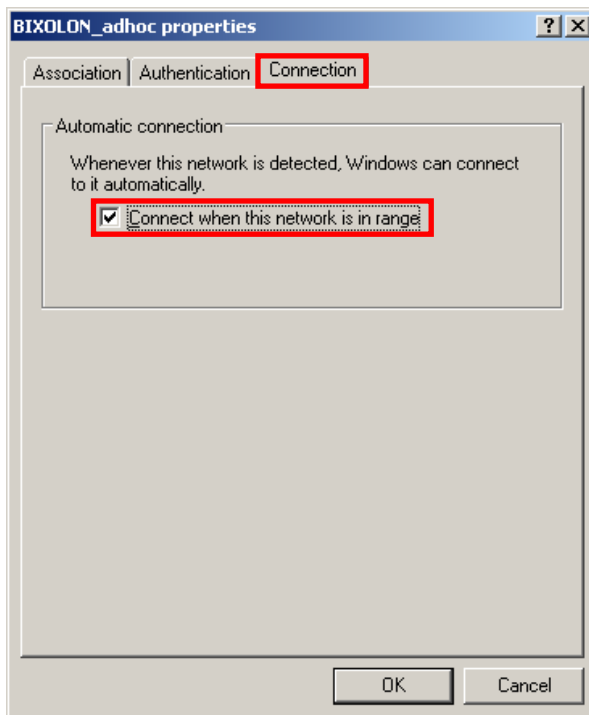

10) Check whether the settings are updated as shown below, and then click [Close]

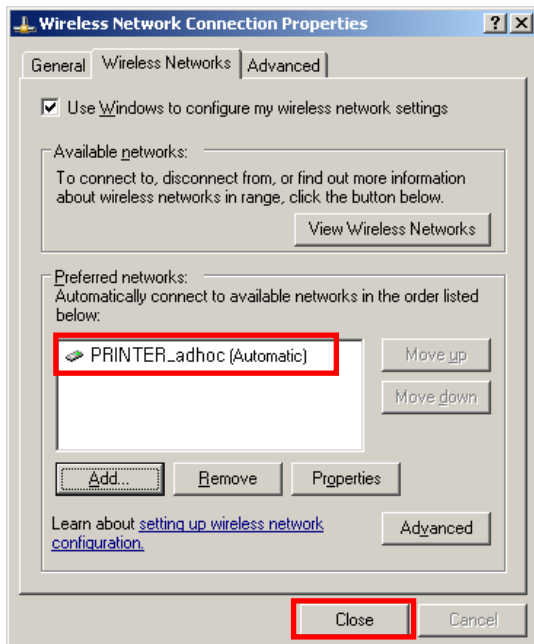

When the printer is set to the default value (Adhoc mode, SSID: PRINTER\_adhoc), it will automatically connect.

# Network Interface

## 4-3 Initial WLAN Connection (Windows VISTA, Windows 7, Windows 8)

When wireless utility program is installed, you have to set the wireless control values via the program, otherwise you have to terminate the program in order to do proper setting after following the steps 'Control Panel>>Administrative tools>>Services>>Wireless Zero Configuration>>Start'.

1) Click the “Start>>Control Panel”.

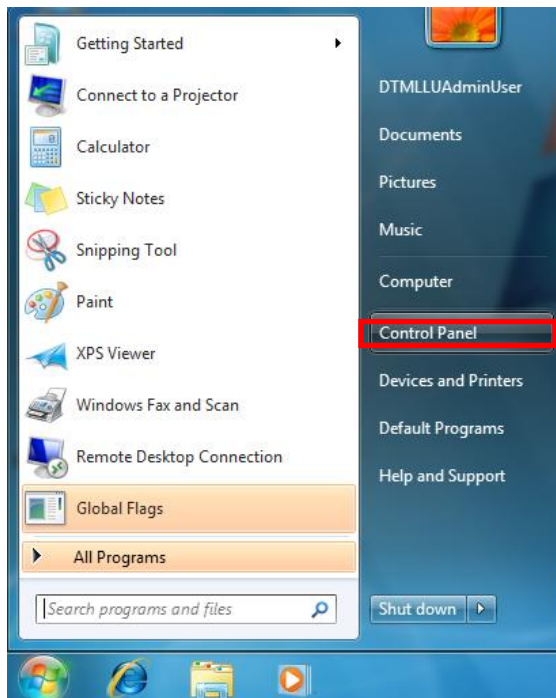

2) Click the “View network status and tasks”.

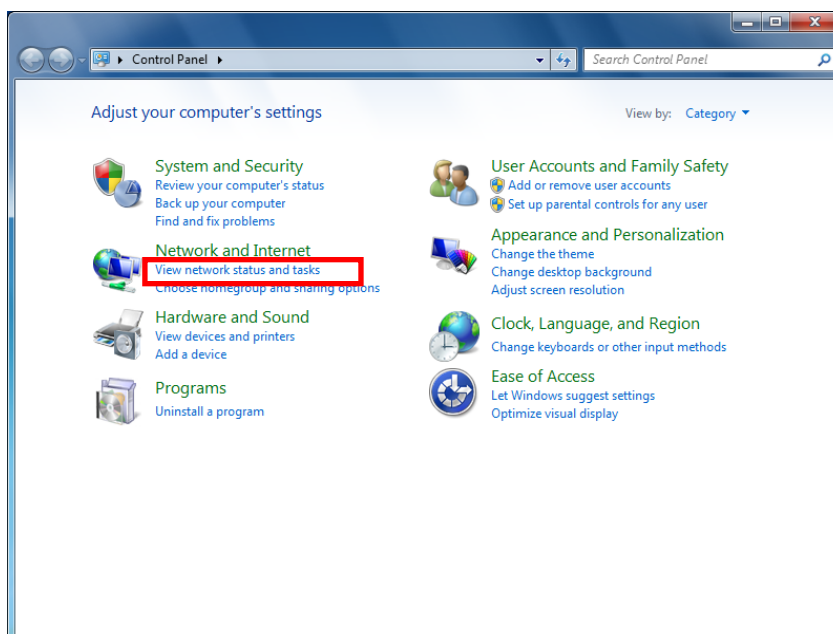

3) Click the “Change adapter settings”.

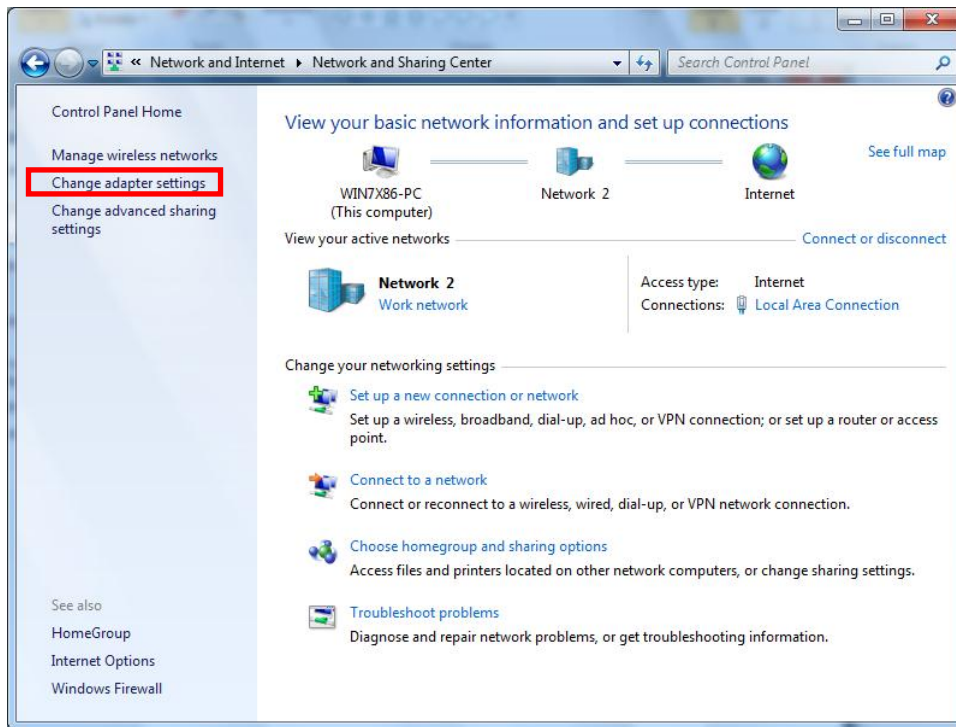

Click the “wireless network adaptor’s Properties”.

4) Select Internet Protocol Version 4(TCP/IPv4), and then click Properties.

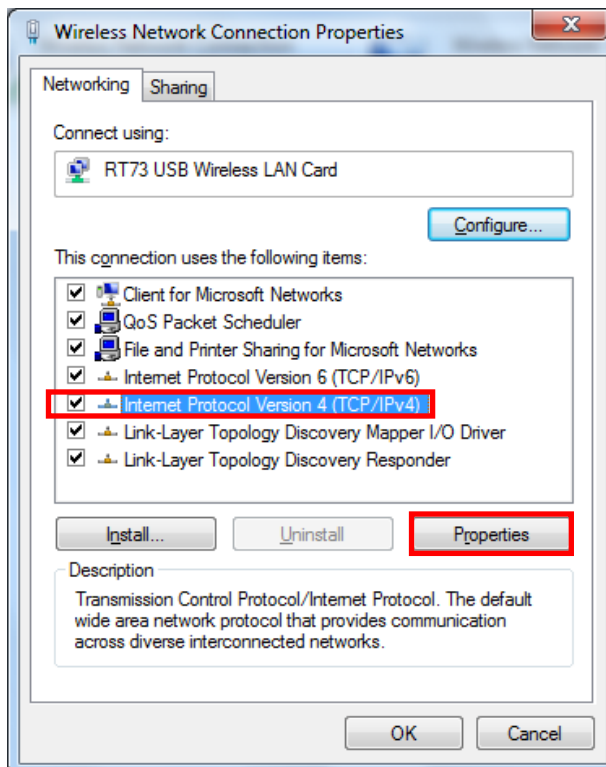

## Network Interface

5) Set the IP settings as shown below, and then click OK.

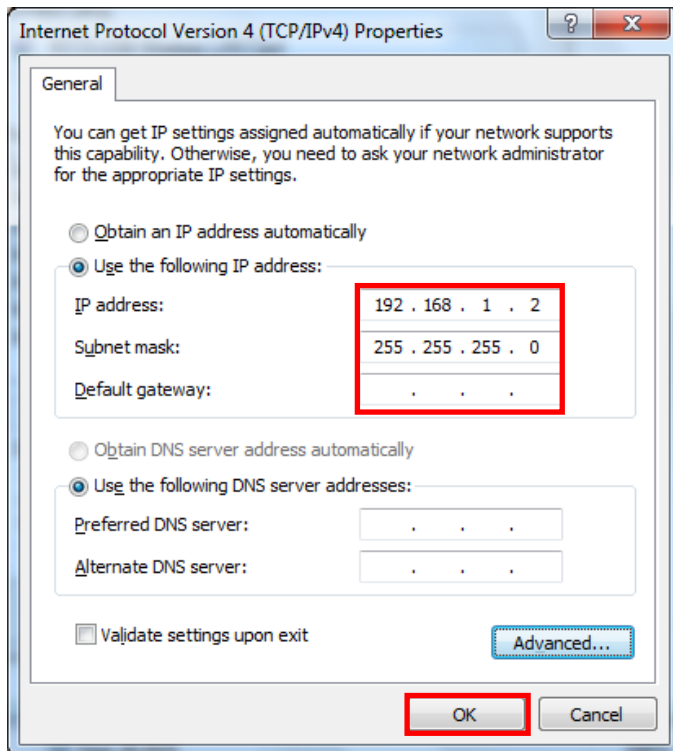

6) Click the “Manage wireless networks”.

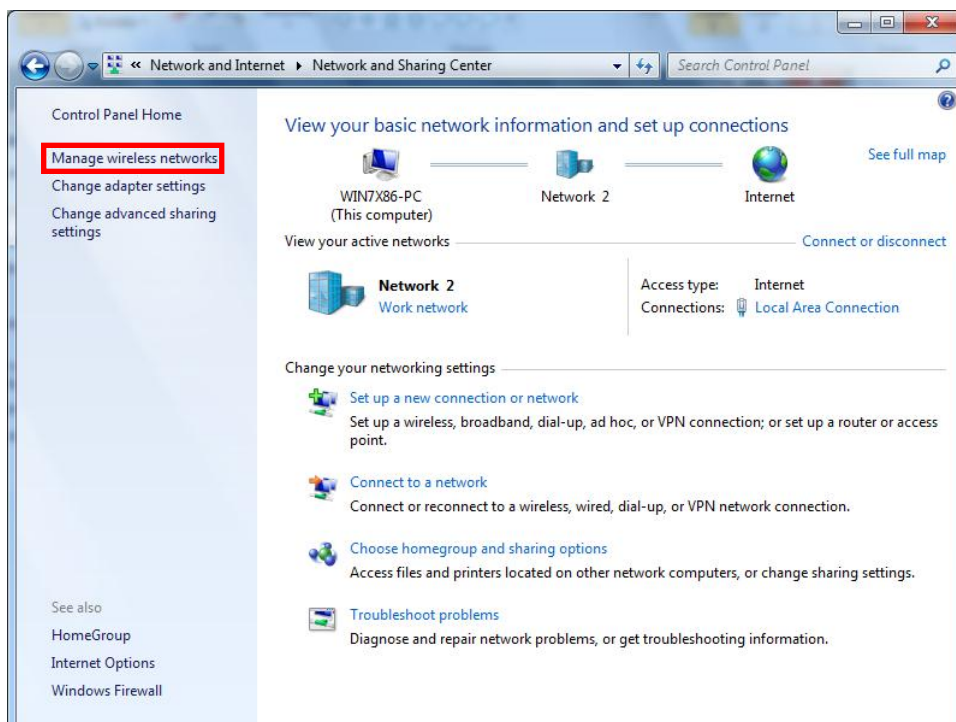

7) Click the “Add”.

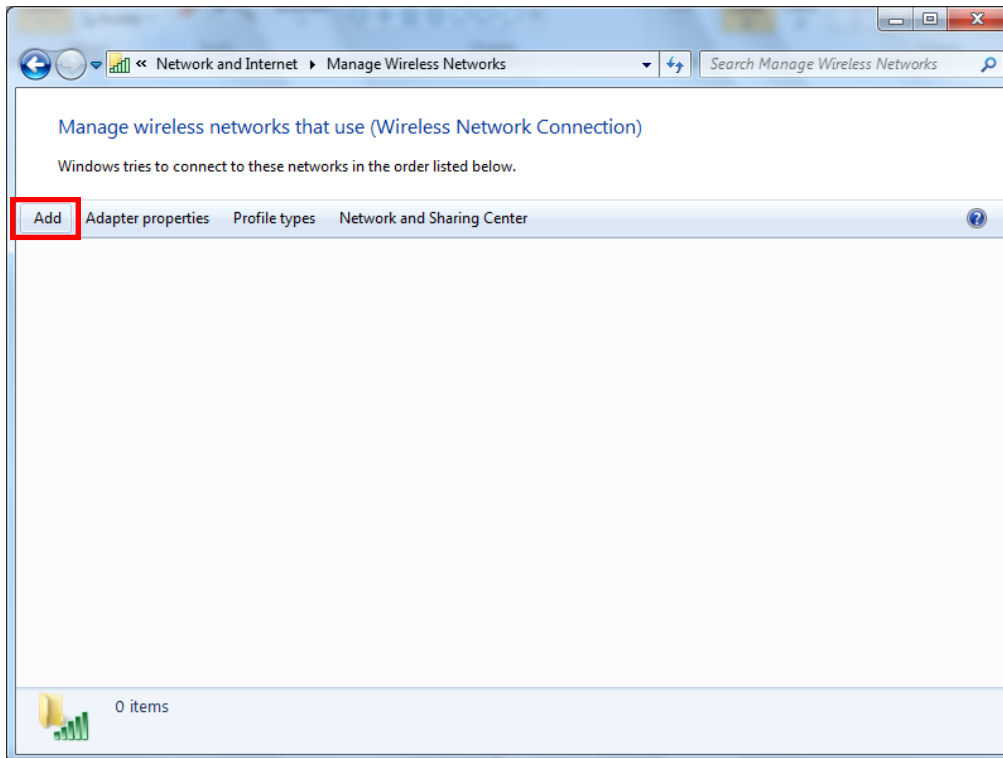

8) Click the “Create an ad hoc network”.

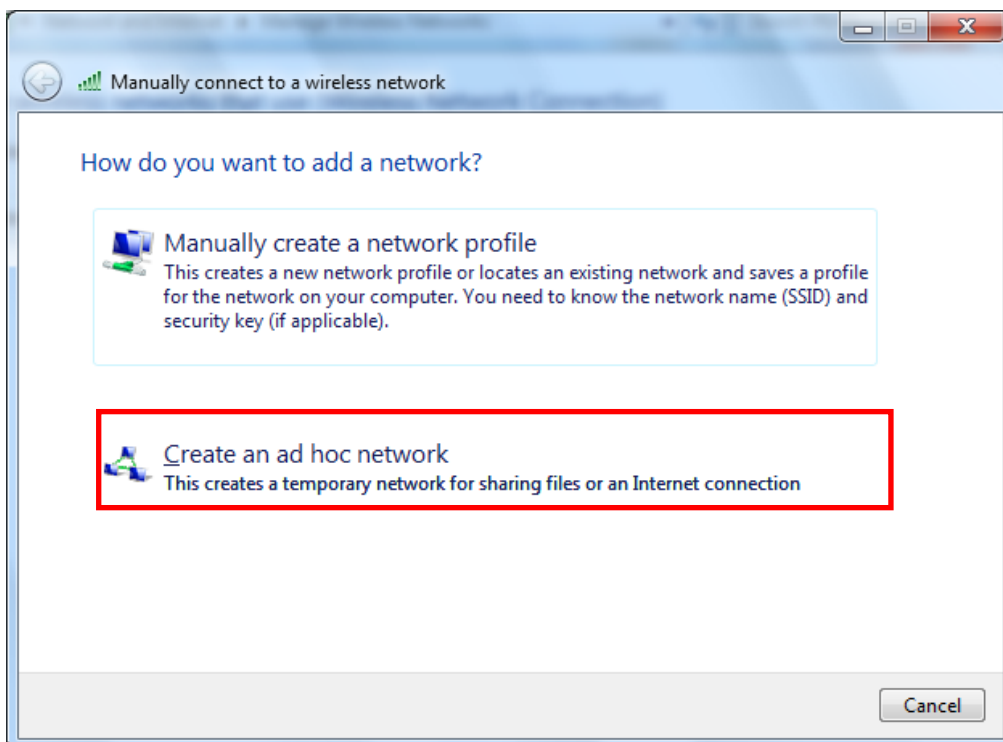



## Network Interface

9) Click the “Next”.



10) 'Network name' = PRINTER\_adhoc,  
'Security type' = Open,  
'Save this network' check, and then click the “Next”.

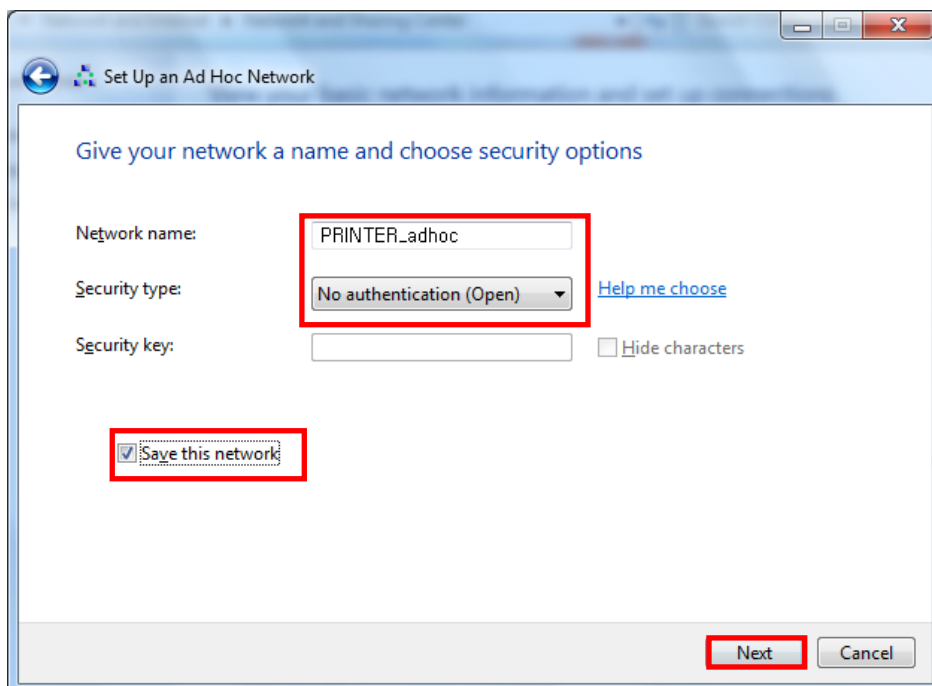

## Network Interface

11) Click the “Close”.

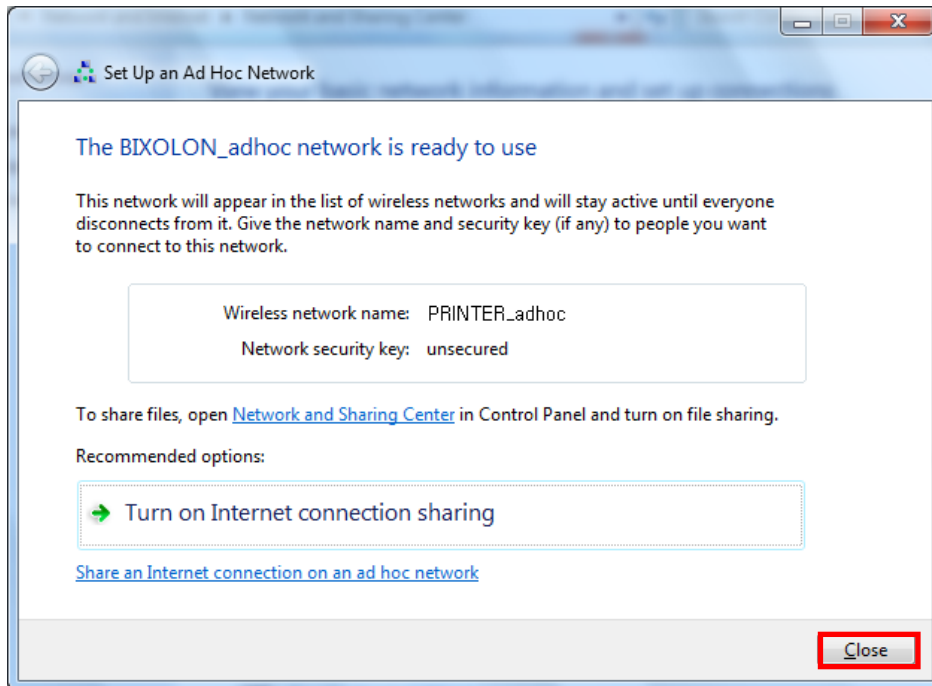

12) After completing configuration, PRINTER\_adhoc network will be created.

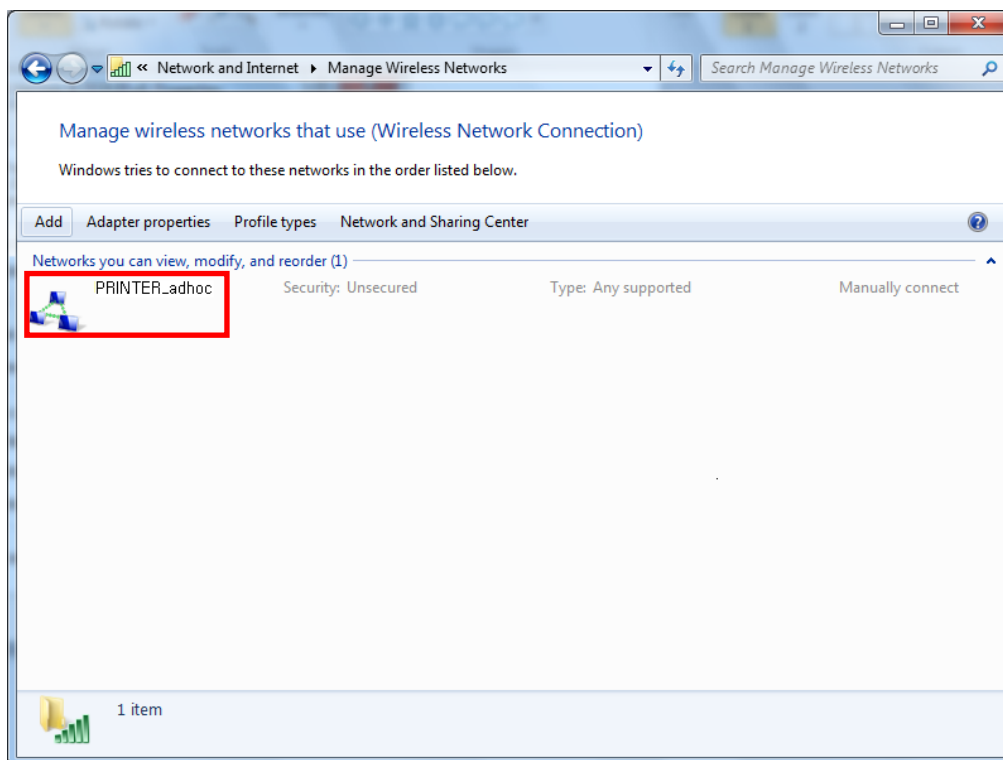

When the printer is set to the default value (Adhoc mode, SSID: PRINTER\_adhoc), it will automatically connect.

### 5. Configuration

#### (1) WLAN Setting Values

Classification	Item	Remarks	Input Range
Home		WLAN setting status display	
System	Printer Name	Printer Name	0~32 letters
	Printer Port	TCP Raw port that the printer can use	0~32767 integers (except 21,23,25,80,443,3318)
	User Name	ID to use for ftp, telnet, web-server log-in	1~32 letters
	User Password	Password to use for ftp, telnet, web-server log-in	1~32 letters
	Confirm Password	Confirm Password	1~32 letters
Protocol	WebServer SSL	Set whether to use HTTPS Http cannot be used when using Https	Enable/Disable
	TELNET	Set whether to use Telnet	Enable/Disable
	FTP	Set whether to use FTP	Enable/Disable
	SNMP	Set whether to use SNMP	Enable/Disable
Network	Network Mode	Wireless LAN operating mode	Infrastructure/Adhoc
	Adhoc Channel	Channel when creating Adhoc network	1~14
	SSID	ID of the AP to connect	1~32 letters
	Inactivity Time	TCP connection hold time	0~3600 integer
	IP Assignment Method	IP Assignment Method	DHCP/Manual
	IP Address	Printer IP	IP Address
	Subnet Mask	Subnet mask	IP Address
	Gateway	Default Gateway	IP Address
Authentication	Authentication	Wireless LAN authentication method	open, shared, wpa1/2-psk, wpa1/2
	Cryptograph	Wireless LAN encryption method	none, WEP64/128, TKIP, AES
	EAP Mode	Authentication method	PEAP, TLS, LEAP, FAST, TLS
	WEP Key	Key for WEP encryption method	WEP64 (5 Ascii, 10 Hex) WEP128 (13 Ascii, 26 Hex)
	PSK Key	Key for PSK encryption method	1~64 letters
	Authentication ID	ID for EAP Authentication	1~32 letters
	Authentication PW	Password for EAP Authentication	1~32 letters
Wizard		Setting wizard for each step	

## Network Interface

### (2) LAN Setting Values

Classification	Item	Remarks	Input Range
Network	Inactivity Time	TCP connection hold time	0~3600 integer
	IP Assignment Method	IP Assignment Method	DHCP/Manual
	IP Address	Printer IP	IP Address
	Subnet Mask	Subnet mask	IP Address
	Gateway	Default Gateway	IP Address

For changing network setting values using Net configuration tool,  
Refer to 'Net configuration tool manual'.

## Network Interface

### 5-1 WLAN Setting: FTP

The configuration files will be downloaded and uploaded to and from the current path. In the following case, the current path is “C:\Documents and Settings”.

Enter “ftp Printer IP”, and enter the ID and Password set for the printer.

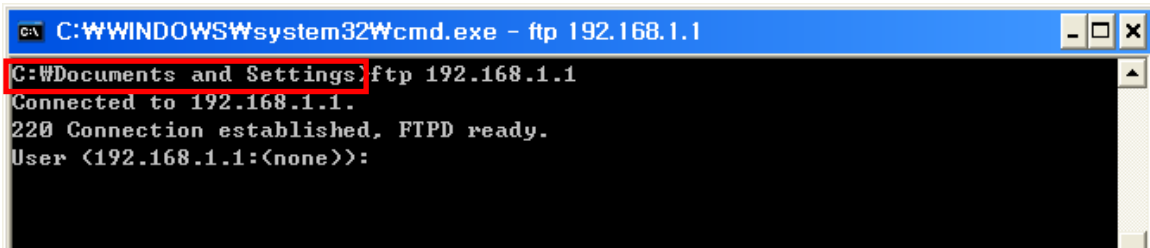

```
C:\WINDOWS\system32\cmd.exe - ftp 192.168.1.1
C:\Documents and Settings>ftp 192.168.1.1
Connected to 192.168.1.1.
220 Connection established, FTPD ready.
User (192.168.1.1:(none)):
```

Enter the “ls” command to check the file name to download.



```
C:\WINDOWS\system32\cmd.exe - ftp 192.168.1.1
ftp> ls
200 PORT command OK.
150 Opening ASCII mode data connection for directory listing.
-rw-rw-rw-  1 config      config      1043 May 12 20:10 config
226 Transfer complete.
ftp: 68 bytes received in 0.50Seconds 0.14Kbytes/sec.
ftp> _
```

Enter “get config” to download the configuration file.

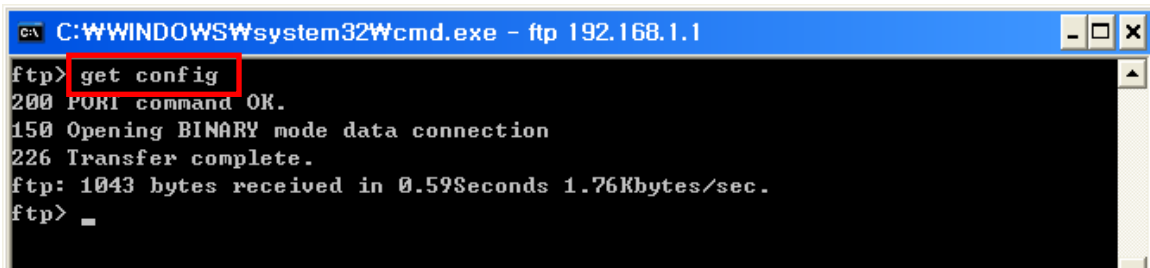

```
C:\WINDOWS\system32\cmd.exe - ftp 192.168.1.1
ftp> get config
200 PORT command OK.
150 Opening BINARY mode data connection
226 Transfer complete.
ftp: 1043 bytes received in 0.59Seconds 1.76Kbytes/sec.
ftp> _
```

You can see that the “get config” file is created in the corresponding directory.

Enter “put config” command if you want to upload the configuration file in the corresponding directory for the printer.

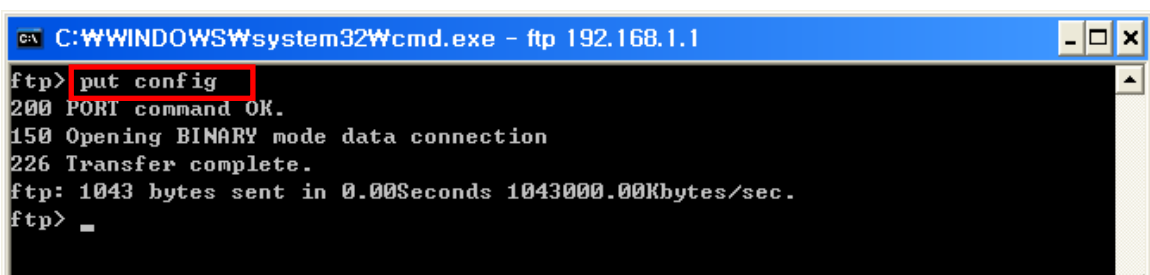

```
C:\WINDOWS\system32\cmd.exe - ftp 192.168.1.1
ftp> put config
200 PORT command OK.
150 Opening BINARY mode data connection
226 Transfer complete.
ftp: 1043 bytes sent in 0.00Seconds 1043000.00Kbytes/sec.
ftp> _
```

## Network Interface

The contents of the config file are as follows.

```
** Caution!!!  
** Do not change the order or contents of the menu.  
** Only need to change the settings, please.  
** Do not input port 21, 23, 80, 161, 162, 3318, 3319, 3337 and 9000 to Printer Port.  
** This number is ignored.
```

### [1] System

1. Printer Name:[SRP-350plusIII]
2. Printer Port Num:[9100]
3. User ID:[admin]
4. User Password:[password]

### [2] Protocol

1. Task State
  - 1) HTTPS:[0]
  - 2) TELNET:[1]
  - 3) FTP:[1]
  - 4) SNMP:[0]
2. SNMP
  - 1) Community Name (Read):[public]
  - 2) Community Name (Write):[private]
  - 3) Trap IP Address:[0.0.0.0]
  - 4) Trap Community:[public]

### [3] Network

1. Network Mode
  - 1) Infra Network(0) / Adhoc(1):[1]
  - 2) Adhoc Channel:[1]
2. SSID:[PRINTER\_adhoc]
3. Inactivity Time:[10]
4. IP Assignment Method:[0]
5. IP Address:[192.168.1.1]
6. Subnet Mask:[255.255.255.0]
7. Gateway:[192.168.1.2]

### [4] Authentication

1. Authentication:[0]
2. Cryptograph:[0]
3. EAP Mode:[0]
4. WEP Key:[]
5. PSK Key:[]
6. Authentication ID:[]
7. Authentication Password:[]

\* The format of the configuration file is "Configuration item: [Setting value]".

Uploading a file that doesn't have the format shown above will not change the setting values.

## 5-2 WLAN Setting: Telnet

Enter "telnet Printer IP".

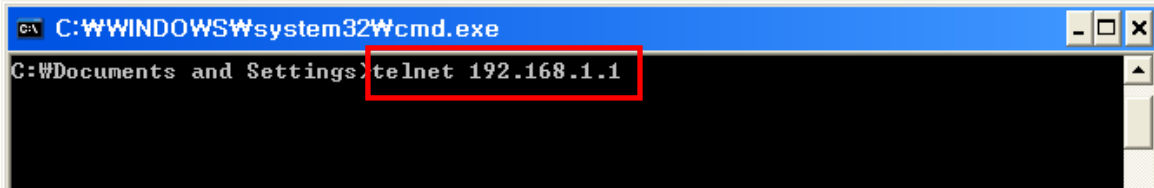

Enter the ID and Password set for the printer.



The screen related to the network configuration will then be displayed. You can select the menu to configure and edit the settings.

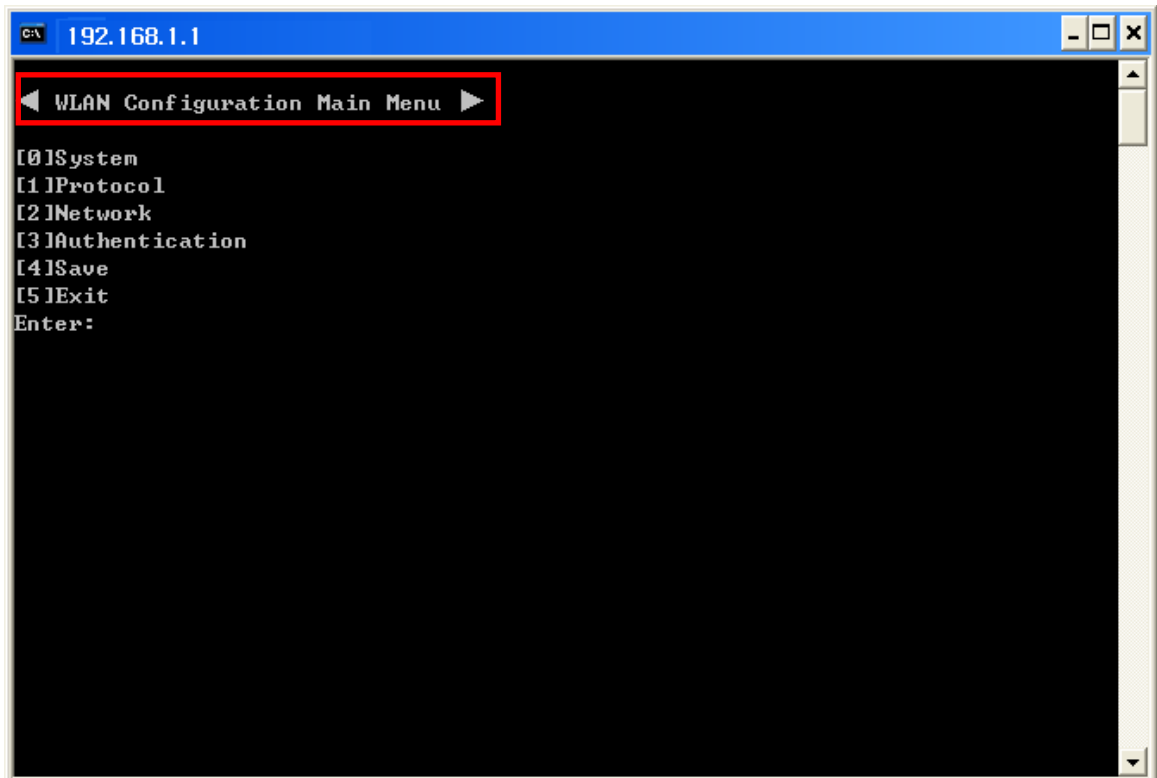

### 6. Ethernet/WLAN Test by using Windows Test Page

You can use the Windows printer driver as shown below when there is no test program. Operating systems that allow you to use the Windows printer driver are Windows 2000, XP, 2003 Server, VISTA, 2008 Server, 7, 8.

1) Install the Windows printer driver.

**[Note]**

-The Windows driver is included in the CD, and you can download the latest version from our home page.

([www.bixelon.com](http://www.bixelon.com))

2) Click the Start button, and then select “Printers and Faxes.”

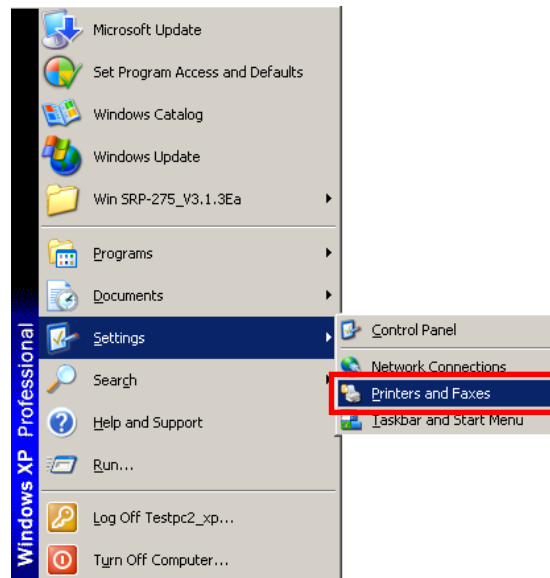

3) Select and right click on the corresponding model, and then select “Properties.”

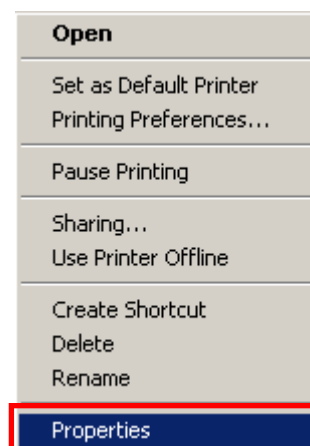



4) Select the “Ports” tab from the “Properties” window.

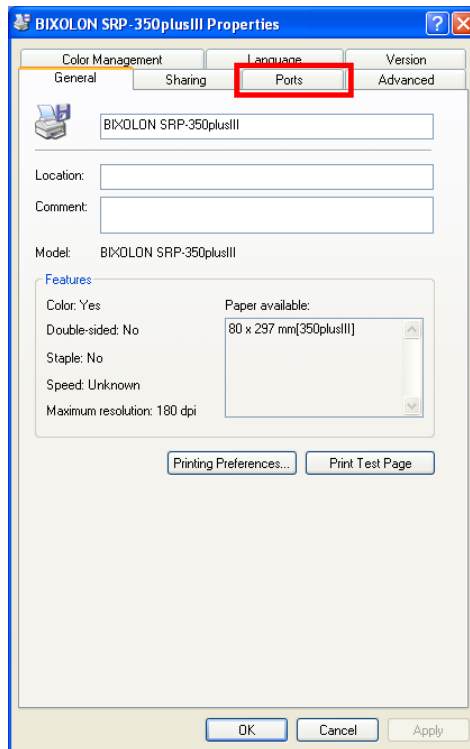

5) Click “Add Port...”

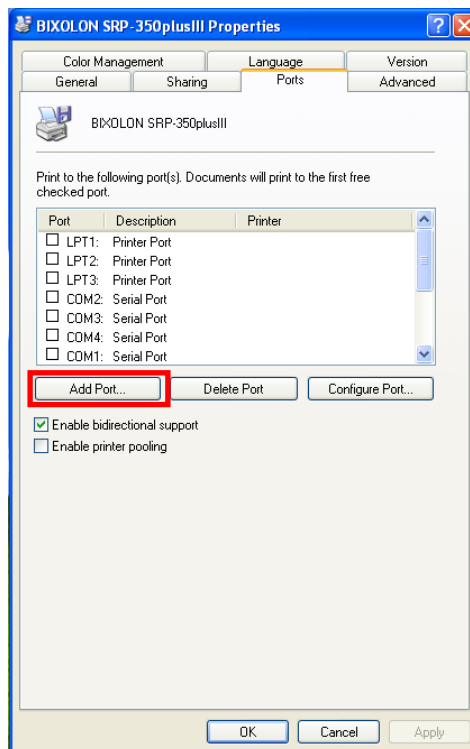

## Network Interface

6) Select “Standard TCP/IP Port” and click “New Port...”

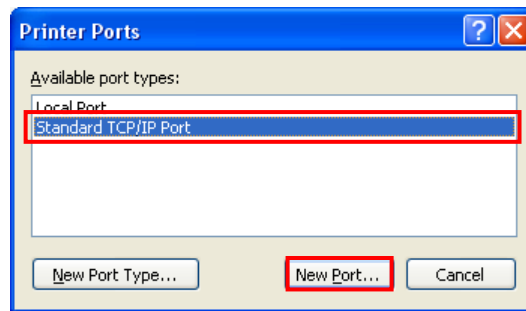

7) Click the [Next] button in the “Add Standard TCP/IP Printer Port Wizard” window.

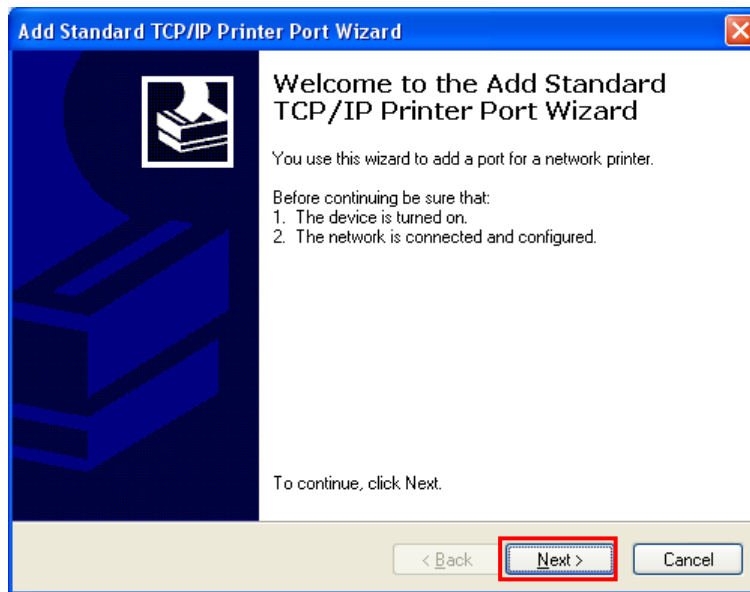

8) Enter the IP address assigned to the printer in the “Printer Name or IP Address” field in the “Add Port” pop up window, and then click the [Next] button.

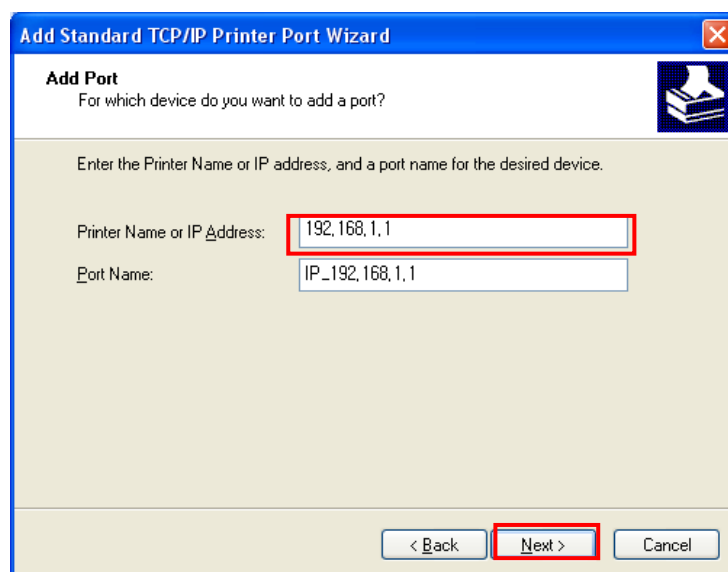

### **[Note]**

- Enter the same IP address entered during the installation of the interface card. Only enter the “Printer name or IP address.”

## Network Interface

9) Click the [Next] button in the “Additional Port Information Required” window.

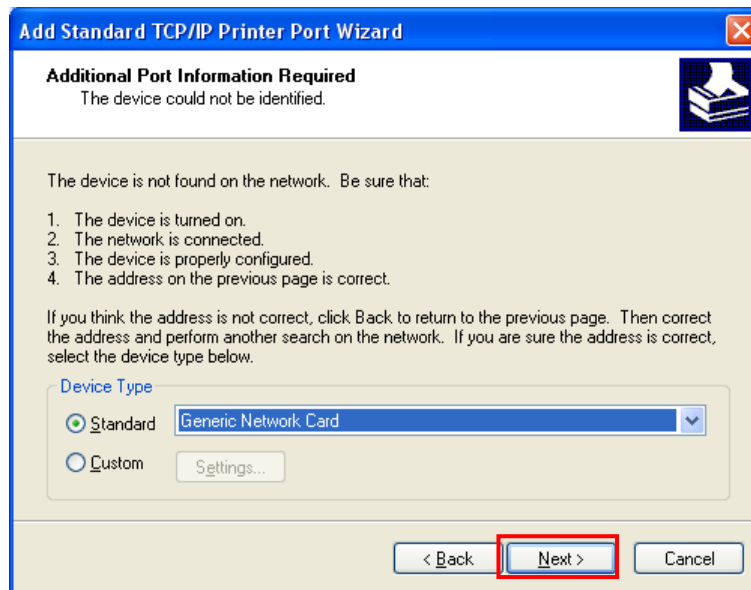

### **[Note]**

- Click the [Next] button to proceed without any changes.

10) Click the [Finish] button at the “Completing the Add Standard TCP/IP Printer Port Wizard” window.

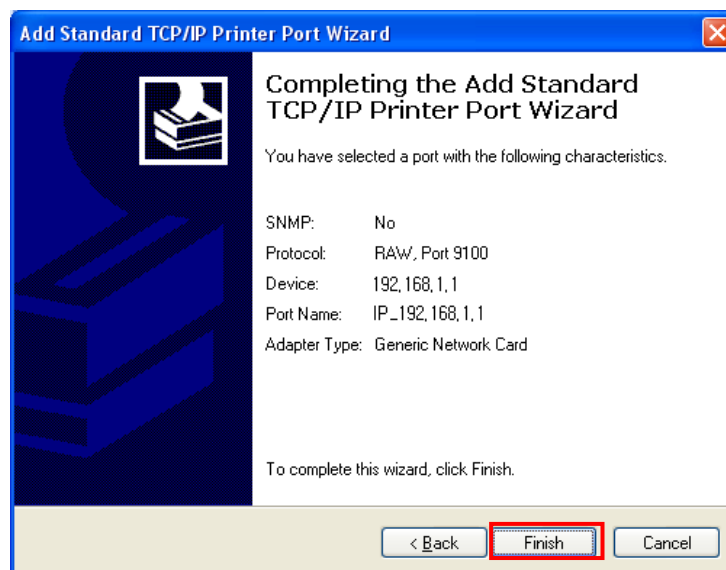

11) Click the “Cancel” button in the Printer Port window, closing the window.

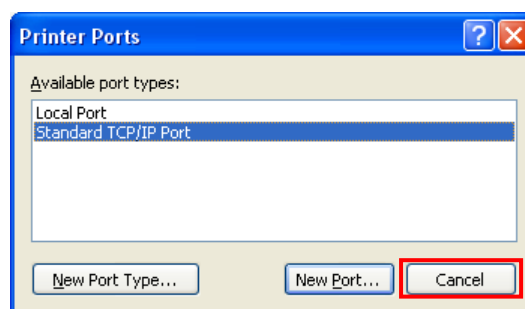

## Network Interface

12) Click the “Configure Port...” button in the “Properties” window.

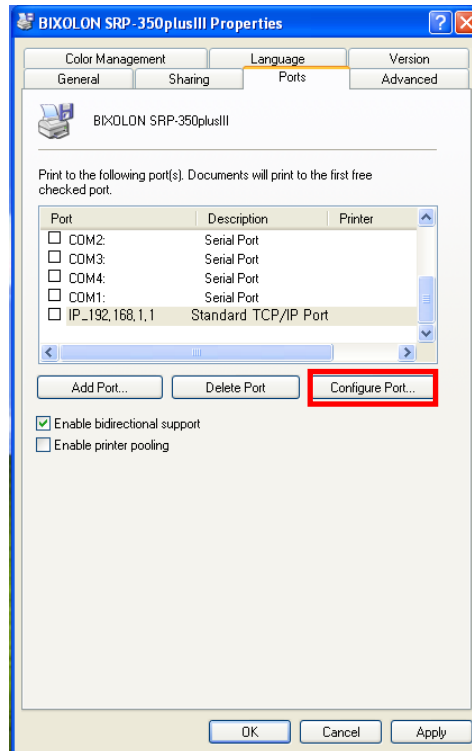

13) Enter the same number as the local port number set during the installation of the interface card in the “Port Number” field in the Raw Settings.

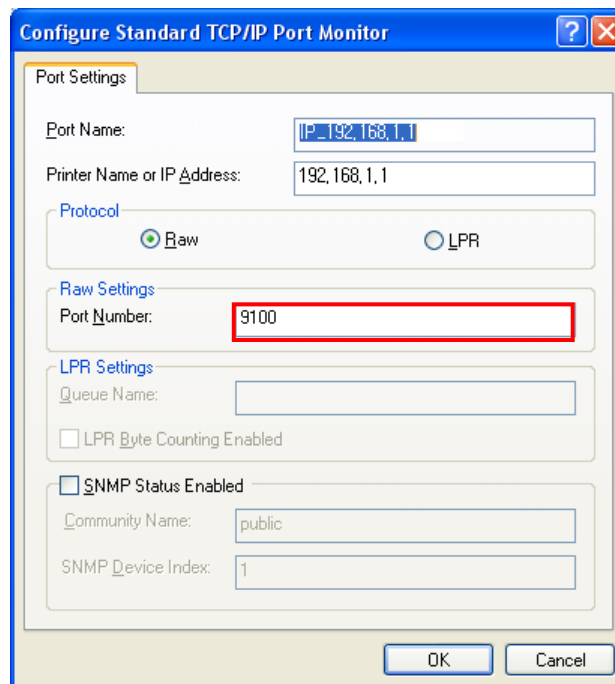

### **[Note]**

- Do not change any other items except the RAW Settings.

## Network Interface

- 14) Click [OK] when you finish entering the required values, and then click the [Apply] button.

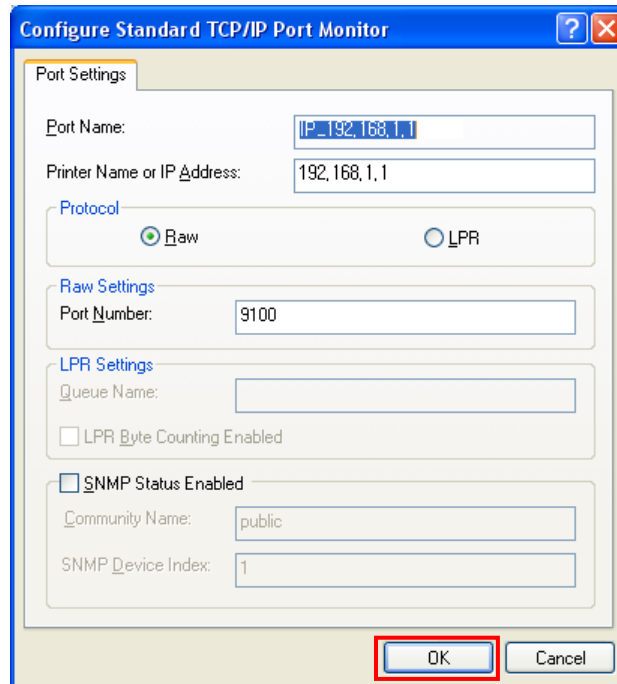

- 15) Select the “General” tab in the Properties window, and then select the “Print Test Page” to check the printing status.

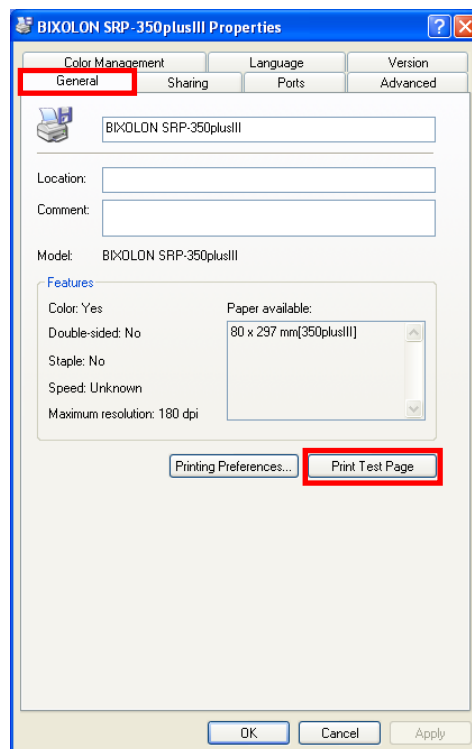

### 7. Factory Reset

This function changes the WLAN settings of the printer to the initial factory settings.

Follow the instructions shown below to perform the Factory Reset.

#### 7-1 Initializing LAN Settings

##### 1) Default Printer Settings

- Dynamic IP mode (DHCP mode is enabled.)
- Local Port: 9100
- Inactivity Time: 0

##### 2) Procedure

- (1) Turn the printer off.
- (2) Turn the printer on while pressing the Function key.

**[Note]**

- Keep holding the Function key for about three seconds.

- (3) Wait for about 10 seconds until IP address is assigned.  
DHCP mode will be enabled when Factory Reset is performed regardless of the existing settings.

**[Note]**

- Dynamic IP network environment  
IP address is assigned to the printer and it can connect to web-server using the assigned IP address.  
Newly assigned IP address can be checked with the Function key.
- Fixed IP network environment  
IP address is not automatically assigned to the printer.  
Wait for 30 seconds and check whether IP address is assigned to the printer by pressing the Function key. If IP address is 0.0.0.0, it means that IP address has not been assigned. In this case, disable DHCP mode using the Configure Tool.

- (4) Print the settings environment using the Function key.  
Check the assigned IP address and connect to the web-server to change the settings.

### 7-2 Initializing WLAN Settings

- 1) Turn the printer on and wait for about 20 seconds until the WLAN interface boots up. The Error/Paper LED will stop blinking when booting is complete.

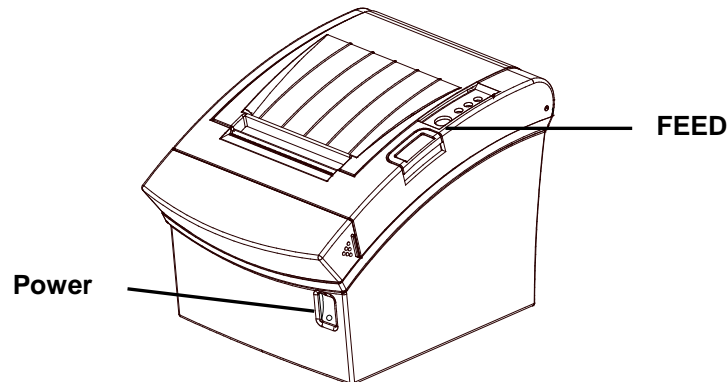

- 2) When booting process is complete, open the printer cover and press the FEED button for five seconds. The internal buzzer will sound five times and printer will be in WLAN selection mode. Mount the paper properly, close the cover, and check that the following information is printed.

#### WLAN Mode Selection

##### Modes

- 0: Exit
- 1: WLAN Information Print
- 2: WLAN Factory Reset and Reboot Printer.
- 3 or more: None

Select Modes by Feed button control as below.

Step 1. Short-press as many times as The mode number to choose.

Step 2. Long-press over 1 second.

\*e.g. To choose Mode 2, press Feed Button 3 times(short-short-long)

- 3) Select Mode 2 when the above message is printed. WLAN settings will be set to factory defaults and the following message will be printed. (Mode 2 can be selected by two short-presses of the Feed button followed by one long-press.)

WLAN Factory Reset OK! Reboot Printer.

After this message is printed, the printer will be rebooted and WLAN settings will be set to factory defaults.

## Network Interface

### 4) Factory Reset Values

WLAN	Printer Name	Printer Name	SRP-350plusIII	
		Printer Port Num	9100	
		User ID	admin	
		User Password	password	
	Protocol	FTP	Disable	
		TELNET	Disable	
		HTTPS	Disable	
		SNMP		Disable
			Community Name(Read) :	"public"
			Community Name(Write) :	"private"
			Trap IP Address :	192.168.1.2
	Trap Community :	"public"		
	Authentication	Open System	None	
		Shared key	None	
	Network	Network Mode	Ad-hoc, channel 1	
		SSID	PRINTER_adhoc	
Inactivity time		10		
IP Assignment Method		manual		
IP, Subnet, Gateway		IP : 192.168.1.1 Subnet : 255.255.255.0 Gateway : 192.168.1.2		
LAN	Network	Inactivity time	0	
		IP Assignment Method	Automatic(DHCP)	



### 8. Troubleshooting

When printing doesn't work

Check network setting

Check the wireless network setting of the AP and the printer.

(Refer to Configuration for checking/changing the printer settings)

- SSID(WLAN only)  
Check whether the SSID of the printer matches with the one in AP (or wireless terminal)
- 802.11 mode(WLAN only)  
Check whether AP supports 802.11b/g/n.  
BIXOLON printer supports 802.11b/g/n, and 802.11a is not supported.
- Network Mode(WLAN only)  
Check the network mode of the printer.  
Network mode must be set to "Infrastructure" to connect to AP and "Ad-hoc" to connect between wireless terminals.
- Authentication / Encryption(WLAN only)  
Check the authentication/encryption setting status.  
Check whether the settings of the printer and the AP (wireless terminals) are the same.
- IP Address  
Check the band of the IP Address.  
Check whether the bands of the printer and the AP (or wireless terminals) are the same.  
The first three digits of the four digit value of the IP address must be the same.
- Subnet Mask  
Check whether the subnet mask of the printer matches the one in AP (or wireless terminal).
- Port  
Check whether the port configured in the printer and the host (PC, PDA) are the same.

PING Check

Checking IP collision

- When entering IP address manually without using DHCP, you must check whether the corresponding IP address is used by other equipment. The printer may not work normally when there is a collision in the IP address.
- When the printer is turned off, carry out the Ping Test to the printer IP.

### Ping TEST

- Turn off the printer.
- Select “Run” from the Windows Start menu, and then enter “cmd”.
- Enter “ARP -d” and delete ARP table.
- Enter “ping {printer IP}”.
- ARP -d, ping {IP address}

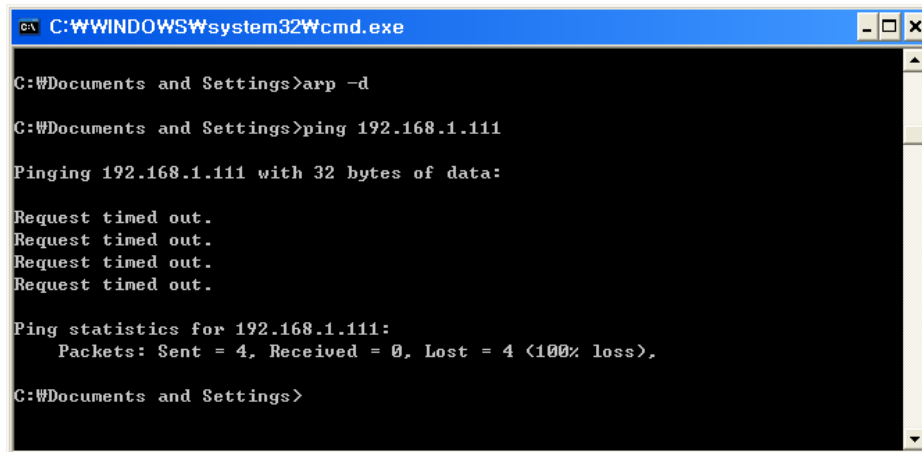

```
C:\WINDOWS\system32\cmd.exe
C:\Documents and Settings>arp -d
C:\Documents and Settings>ping 192.168.1.111
Pinging 192.168.1.111 with 32 bytes of data:
Request timed out.
Request timed out.
Request timed out.
Request timed out.
Ping statistics for 192.168.1.111:
    Packets: Sent = 4, Received = 0, Lost = 4 (100% loss),
C:\Documents and Settings>
```

When you see “Request timed out.” as shown below, it means that there is no collision. The corresponding IP can be used.

On the other hand, if there is a reply as shown below, then the corresponding IP is used by another network terminal and it cannot be used for the printer IP.

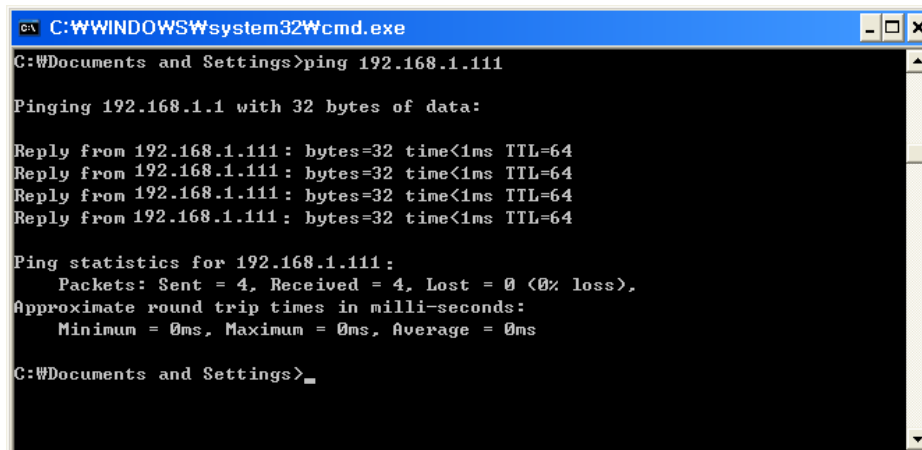

```
C:\WINDOWS\system32\cmd.exe
C:\Documents and Settings>ping 192.168.1.111
Pinging 192.168.1.111 with 32 bytes of data:
Reply from 192.168.1.111: bytes=32 time<1ms TTL=64
Reply from 192.168.1.111: bytes=32 time<1ms TTL=64
Reply from 192.168.1.111: bytes=32 time<1ms TTL=64
Reply from 192.168.1.111: bytes=32 time<1ms TTL=64
Ping statistics for 192.168.1.111:
    Packets: Sent = 4, Received = 4, Lost = 0 (0% loss),
Approximate round trip times in milli-seconds:
    Minimum = 0ms, Maximum = 0ms, Average = 0ms
C:\Documents and Settings>
```

### Inactivity Time

If multiple host devices are used with one printer, “Inactivity Time” is recommended. (Other host devices are restricted to use a printer if one host device keep connecting to a printer.), ex> 5sec