

BIXOLON®

Network Connection Manual

SRP-Q300/302

Thermal Printer
Rev. 1.01

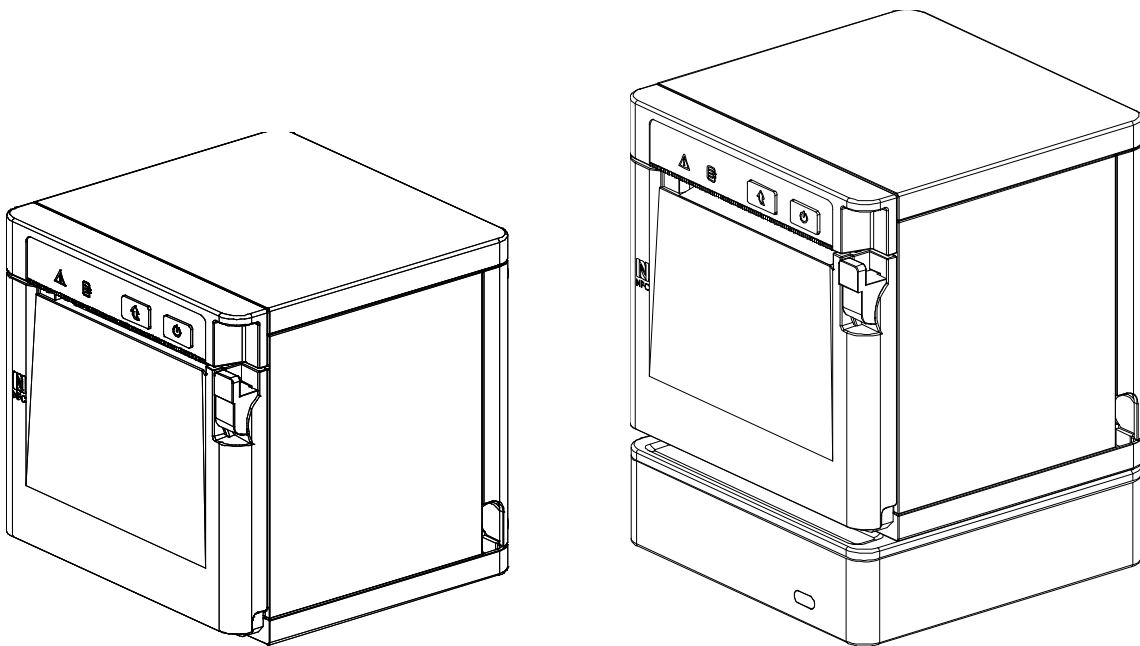

<http://www.bixolon.com>

■ Table of Contents

1. Manual Information.....3

2. Precautions3

3. How to Connect (Printer only)4

 3-1 Android Soft AP mode7

 3-2 iOS Soft AP mode.....8

 3-3 How to change Infrastructure mode.....9

4. Factory Reset (Printer only).....11

5. Specifications (B-gate only).....13

6. How to Connect (B-gate only).....14

 6-1 Initial Wireless LAN Connection (Windows 2000).....15

 6-2 Initial Wireless LAN Connection (Windows XP)15

 6-3 Initial Wireless LAN Connection (Windows VISTA, Windows 7, 8, 10).....20

 6-4 Initial Wireless LAN Connection (iOS)26

7. Configuration (B-gate only)27

 7-1 LAN Setting Values.....27

 7-2 WLAN Setting Values27

 7-3 Web Browser28

8. Network Status Check (B-gate only)29

9. Troubleshooting (B-gate only).....30

1. Manual Information

This WLAN manual provides information on the connection of wireless network with the mobile printer.

We at BIXOLON maintain ongoing efforts to enhance and upgrade the functions and quality of all our products. In following, product specifications and/or user manual content may be changed without prior notice.

2. Precautions

- 2-1 The printer has to be within 100m(Out door) from AP(Access point) to connect WLAN. Although 35m is able to communicate in door, WLAN could be affected by environment to be shorten.
- 2-2 The maximum separating distance may be shortened if transmission obstacles, such as cement walls, are present
- 2-3 If a device (such as a microwave oven, wireless LAN, etc.) that uses the same frequency is present, transmission may be interrupted. Separate the printer and Bluetooth-enabled device from such interrupting devices by a distance of at least 5m.
- 2-4 As to Normal POS printer and B-gate printer, both have different concept of usage, resulting to different way of printer connection, setting and functioning. Accordingly, this manual explains the printer connection, setting and functioning on normal POS printer and B-gate printer separately.

3. How to Connect (Printer only)

WLAN can be configured through the printer's WLAN interface. Likewise, WLAN can also be configured through the printer's USB interface.

(1) Connecting Printer

1) USB cable

Connect USB cable to Printer, PC device.

Use the "Net Configuration Tool" to adjust the settings.

2) WLAN

Connect to the AP (Access Point) configured in Infrastructure mode in order to connect to the LAN/wireless network

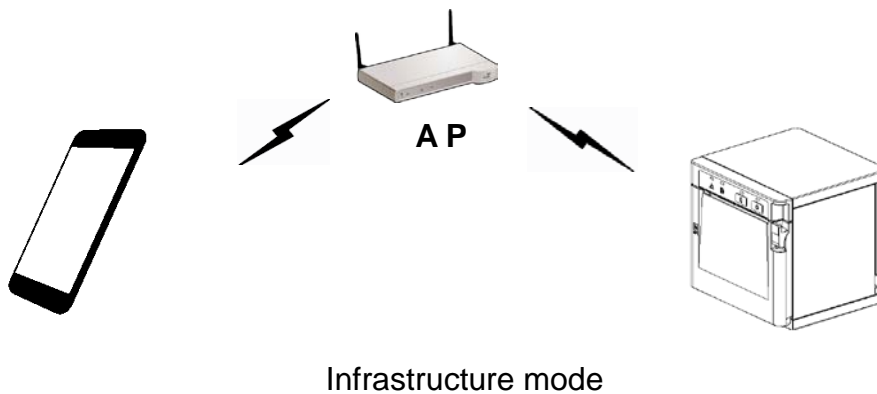

In order to configure the network between the wireless host device and the printer, set the printer to Soft AP Mode.

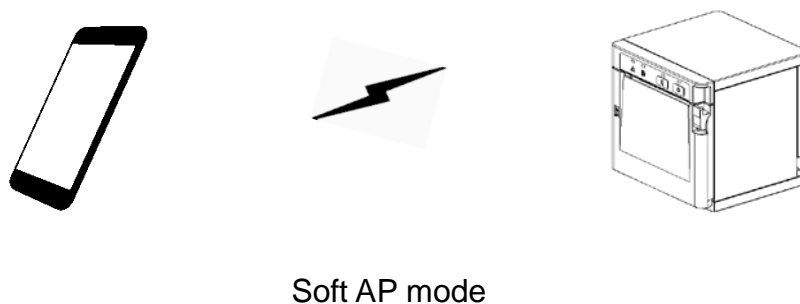

(2) Checking Network Setting

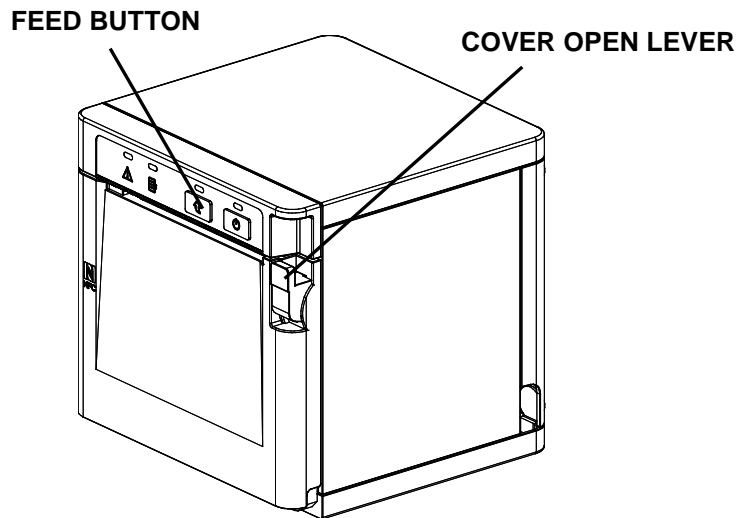

After the printer has finished booting, open the printer cover and press and hold the FEED button for 5 seconds. This will cause the internal buzzer to buzz 5 times and enter the interface setting confirmation mode. Then add the paper, close the cover, and check that the following message is printed.

* For models not supported by WLAN, the Error/Paper ELD will be toggled until WLAN is booted.

Checking Interface Setting

- 0: Exit
- 1: LAN Information Print
- 2: LAN Factory Reset and Reboot Printer
- 3: WLAN Information Print
- 4: WLAN Factory Reset and Reboot Printer
- 5 or more: None

Select Modes by Feed button control as below.

Step 1. Short-press as many times as
The mode number to choose.

Step 2. Long-press over 1 second.

*e.g. To choose Mode 2, press Feed
Button 3 times(short-short-long)

If the above message is printed, select Mode 1, and you will see the following LAN data.
(To select Mode 1, press the Feed button once quickly/ once long.)

* For models not supported by WLAN, numbers 3 and 4 will not be printed.

<LAN Information Printing>

LAN SETTING
MAC ADDRESS :
00:15:94:C2:6B:A8
IP ADDRESS : 192.168.0.48
SUBNET MASK: 255.255.255.0
GATEWAY : 192.168.0.1
PORT : 9100
INACT. TIME : 0

<WLAN Information Printing>

WLAN SETTING
WLAN F/W VERSION : 02.00(3930)
SYSTEM NAME : SRP-Q300
NETWORK MODE : SOFT AP
FREQUENCY : (Priority) 2.4GHz/5GHz
AUTHENTICATION : OPEN
ENCRYPTION : NONE
ESSID : PRINTER_B03223
DHCP : ENABLED
IP ADDRESS : 192.168.1.1
SUBNET MASK: 255.255.255.0
GATEWAY : 192.168.1.2
PORT : 9100
WLAN MACADDRESS :

0 0 1 5 9 4 B 0 3 2 2 3

3-1 Android Soft AP mode

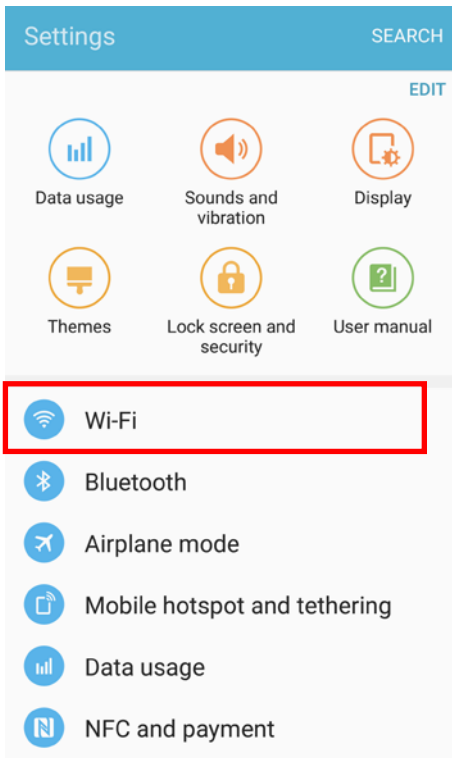
1) Select "Wi-Fi".



2) Select the printer to connect.



3) Select "CONNECT".

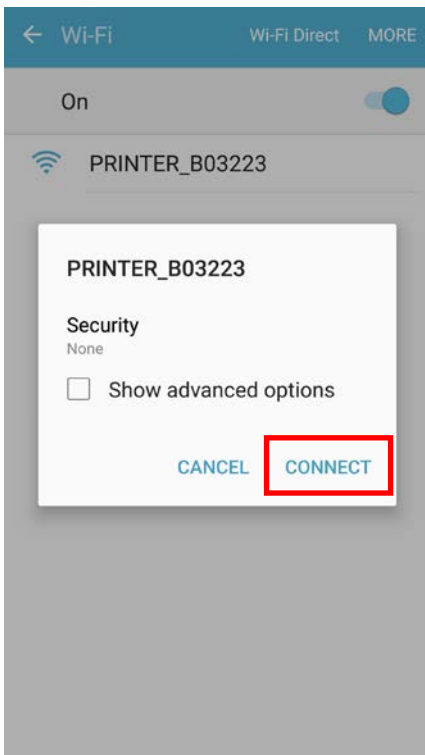

4) Wi-Fi communication is available.

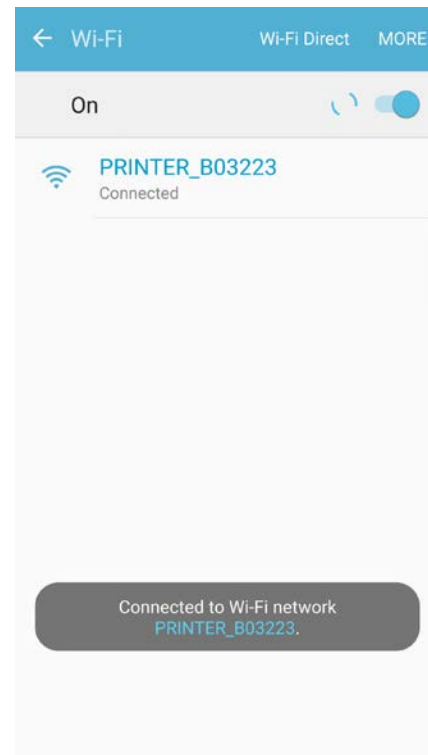

3-2 iOS Soft AP mode

1) Select "Wi-Fi".

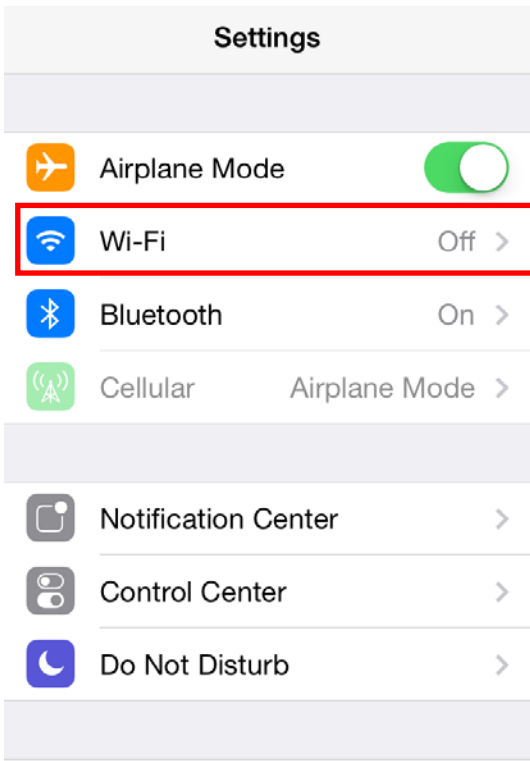

2) Wi-Fi ON and Select the printer to connect.

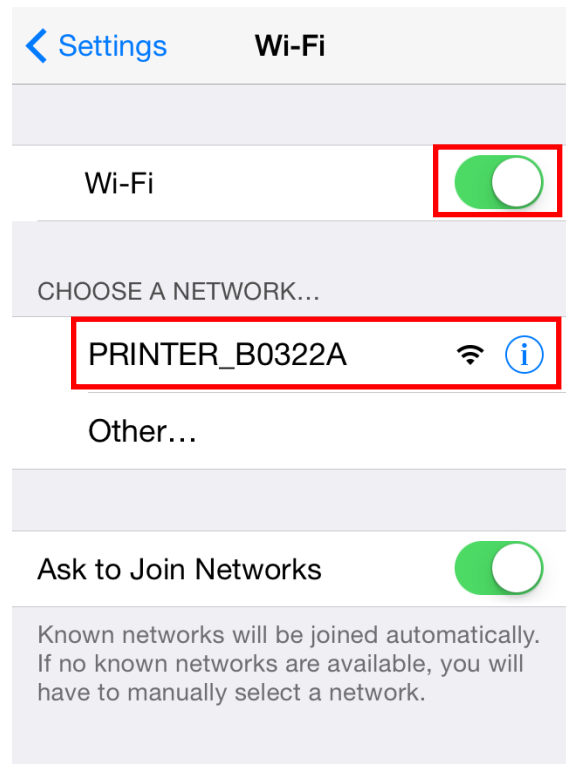

3) Wi-Fi communication is available.

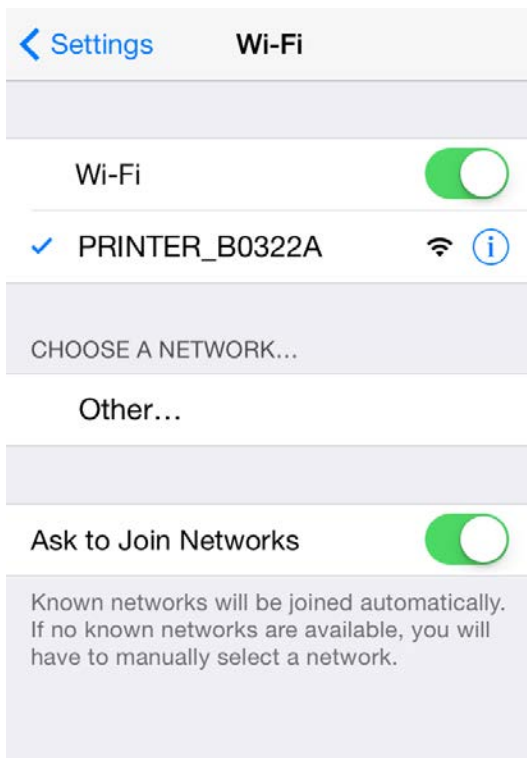

3-3 How to change Infrastructure mode

- 1) Enter the IP address of the printer in the address bar, and the following login window will pop up. Enter the ID and Password set for the printer, and then click [LOG IN]
(Default User Name: admin, Password: password)

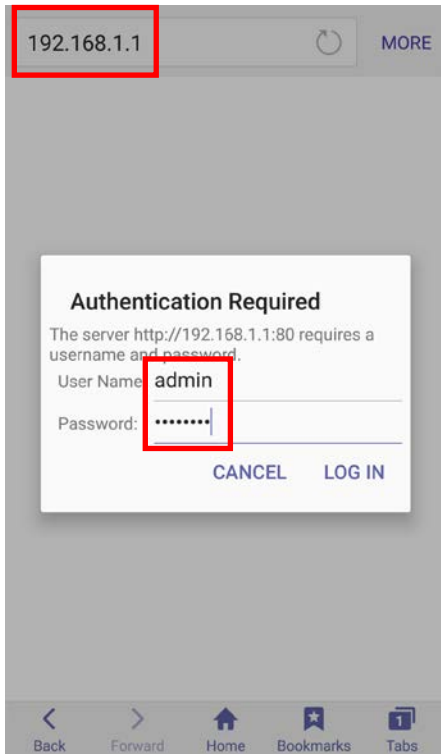

- 2) Select “Wireless” to change Wi-Fi mode.

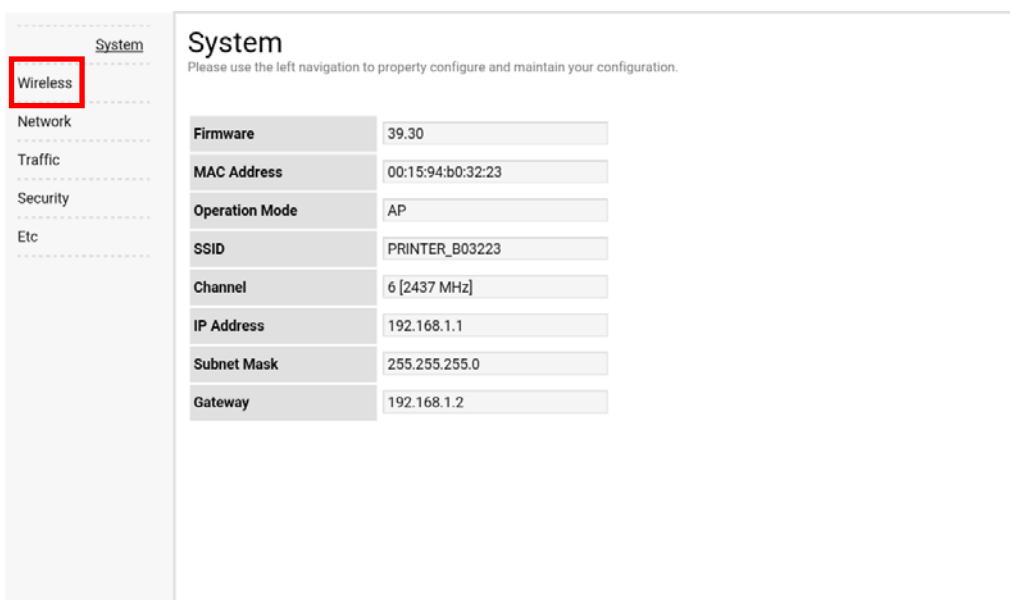

3) Select “Infrastructure”, and set SSID, WLAN Security Type.

The screenshot displays the 'Wireless' configuration page. On the left is a navigation menu with options: System, Wireless, Network, Traffic, Security, and Etc. The main content area is titled 'Wireless' and includes the instruction: 'Please use the left navigation to property configure and maintain your configuration.' Below this, there are three configuration fields: 'Connection Type' with a dropdown menu showing 'Infrastructure', 'SSID' with a text input field containing 'TEST_AP', and 'WLAN Security Type' with a dropdown menu showing 'Open'. To the right of the 'WLAN Security Type' field is an unchecked checkbox labeled 'Enterprise'. A red rectangular box highlights the 'Connection Type' and 'WLAN Security Type' dropdown menus. Below the fields, a warning message reads: 'If you try connect, this connection will be disconnected.' At the bottom right of the configuration area is a 'Save' button.

4) Reboot the Printer.

4. Factory Reset (Printer only)

This function changes the LAN/WLAN settings of the printer to the initial factory settings.

Method

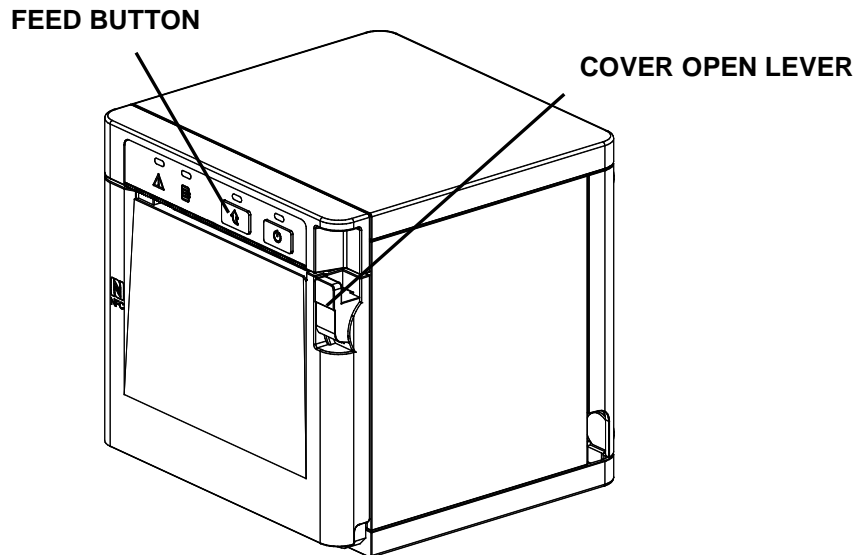

After the printer has finished booting, open the printer cover and press and hold the FEED button for 5 seconds. This will cause the internal buzzer to buzz 5 times and enter the interface setting confirmation mode. Then add the paper, close the cover, and check that the following message is printed.

Checking Interface Setting

- 0: Exit
- 1: LAN Information Print
- 2: LAN Factory Reset and Reboot Printer
- 3: WLAN Information Print
- 4: WLAN Factory Reset and Reboot Printer
- 5 or more: None

Select Modes by Feed button control as below.

Step 1. Short-press as many times as
The mode number to choose.

Step 2. Long-press over 1 second.

*e.g. To choose Mode 2, press Feed
Button 3 times(short-short-long)

If the above message is printed, select Mode 2, and you will see the following LAN information. (To select Mode 2, press the Feed button twice quickly / once long.)

* For models not supported by WLAN, numbers 3 and 4 will not be printed.

LAN Factory Reset OK! Reboot Printer.

After the above message is printed, the printer will automatically reboot.

Factory Reset Values

System	Printer Name	*Printer model
	Printer Port Num	9100
	User ID	admin
	User Password	password
Enc / Auth	Encryption	None/Open
Network	Network Mode	Soft AP mode
	SSID	PRINTER_{MAC address}
	Inactivity time	10
	IP Assignment Method	Manual (DHCP server)
	IP, Subnet, Gateway	IP : 192.168.1.1 Subnet : 255.255.255.0 Gateway : 192.168.1.2

Specification

Feature	Implementation
Operation Mode	Infrastructure, Soft AP, Ad-hoc, Wi-Fi Direct
Wireless Standard	IEEE 802.11b/g/n, IEEE 802.11a/b/g/n
Range	Up to 100m free space (Outdoor)
Security	WEP64/128
	WPA1/2 – PSK
	WPA 1/2 – Enterprise (EAP-TLS, EAP-TTLS, PEAP, LEAP, EAP-FAST)
Management	WLAN Configuration tool, HTTP, Smart connection APP

5. Specifications (B-gate only)

(1) WLAN USB Adapter

BIXOLON B-gate printers require WLAN USB adapter to use the wireless LAN function.

WLAN USB Adapter for BIXOLON printers should be available from BIXOLON.

USB Adapter from market not BIXOLON is not guaranteed to be working properly with BIXOLON B-gate.

(2) Ethernet(LAN) / WLAN Protocol

Layer	Protocol
Network Layers	ARP, IP, ICMP
Transport Layers	TCP, UDP
Application Layers	DHCP, DNS Raw Print HTTP

(3) WLAN Security

- WEP
- WPA/WPA2 (TKIP/AES-CCMP/TKIP+AES) PSK
- EAP(PEAP, FAST, LEAP, TTLS)

6. How to Connect (B-gate only)

Both Ethernet and WLAN can be configured through the printer's Ethernet interface. Likewise, both Ethernet and WLAN can also be configured through the printer's WLAN interface. When you want to change the Ethernet or WLAN of the printer, the network settings of the host (PC, PDA, etc) and Ethernet or WLAN of the printer must be configured properly so that communication can be established.

(1) Connecting B-gate

1) Ethernet(LAN)

Connect the LAN cable to the B-gate.

A direct cable or cross cable can be connected to the Hub or Host for use.

2) WLAN

Connect to the AP (Access Point) configured in Infrastructure mode in order to connect to the LAN/wireless network.

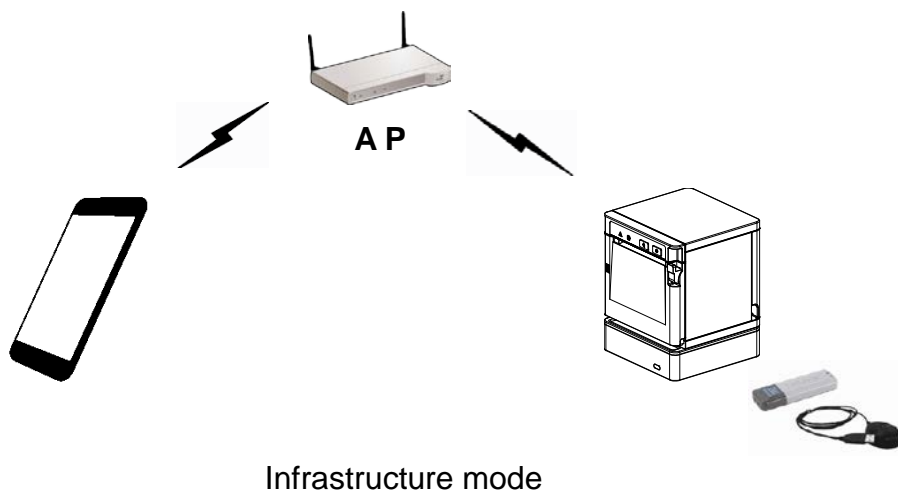

In order to configure the network between HOST to B-gate, connect to the terminal in Ad-hoc Mode.

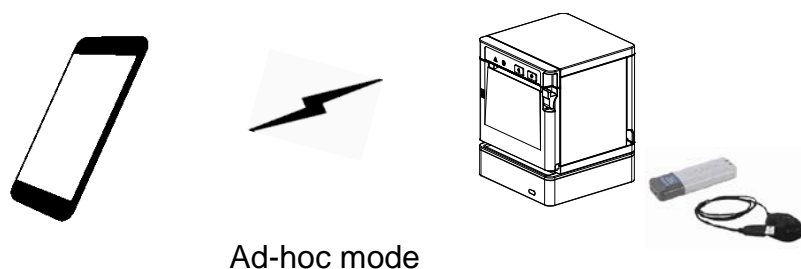

6-1 Initial Wireless LAN Connection (Windows 2000)

Windows 2000 does not support wireless network setting.

When you use Windows 2000, you need to set the utility option as below after installing utility program related to the wireless LAN driver that you use.

- Network mode : Ad-hoc
- SSID : BIXOLON_adhoc
- IP address : 192.168.1.2
- Subnet Mask : 255.255.255.0
- Authentication(Encription) : Open(None)

6-2 Initial Wireless LAN Connection (Windows XP)

When wireless utility program is installed, you have to set the wireless control values via the program, otherwise you have to terminate the program in order to do proper setting after following the steps “Control Panel>>Administrative tools>>Services>>Wireless Zero Configuration>>Start”.

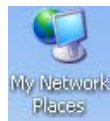

1) Right click on the  icon, and select Properties.

2) Select and right click on the Wireless Network Connection, and then select Properties.

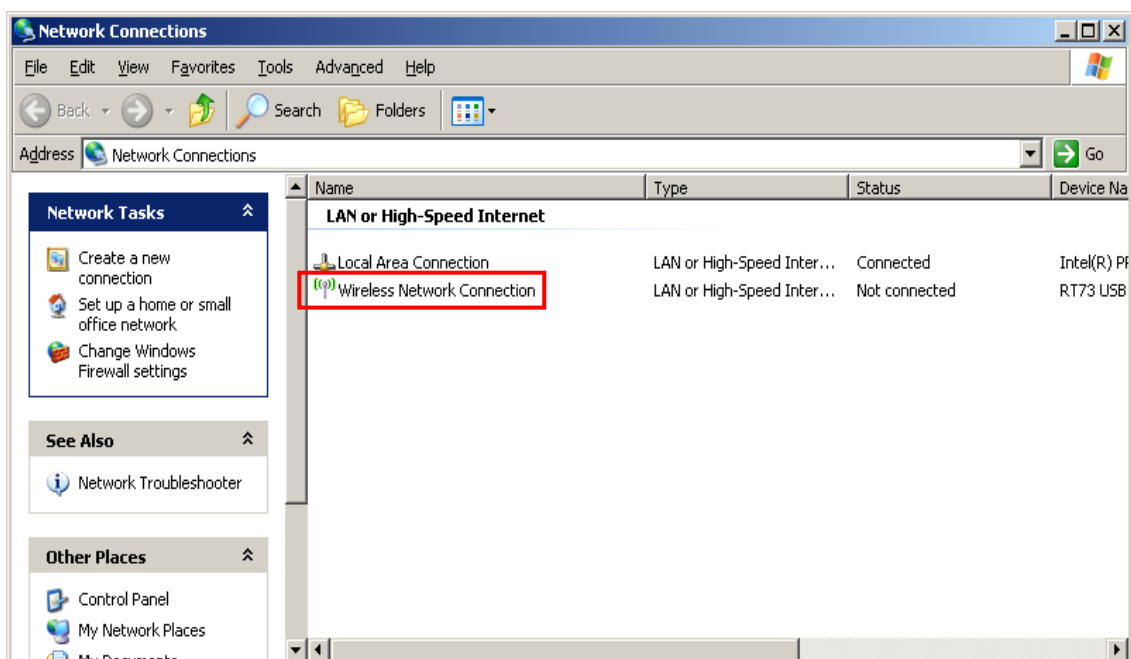

3) Select Internet Protocol (TCP/IP), and then click “Properties”.

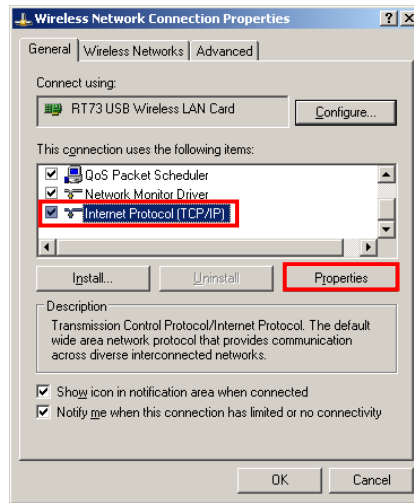

4) Set the IP settings as shown below, and then click “OK”.

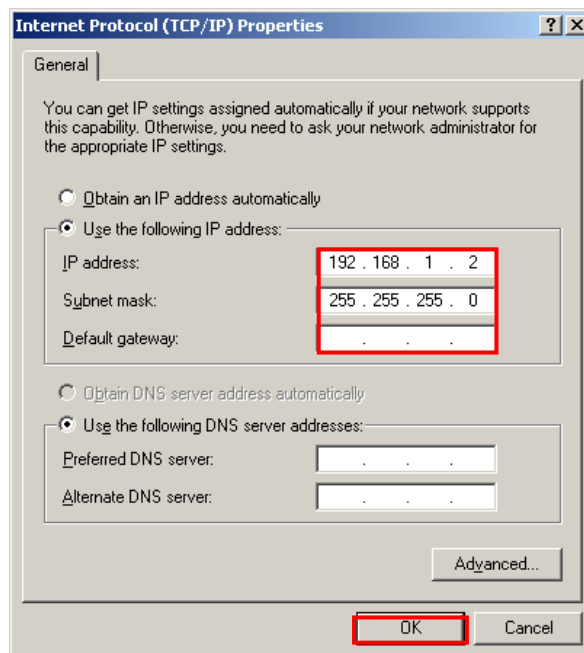

5) Select the Wireless LAN tab, and then select “Use Windows to configure my wireless network settings.”

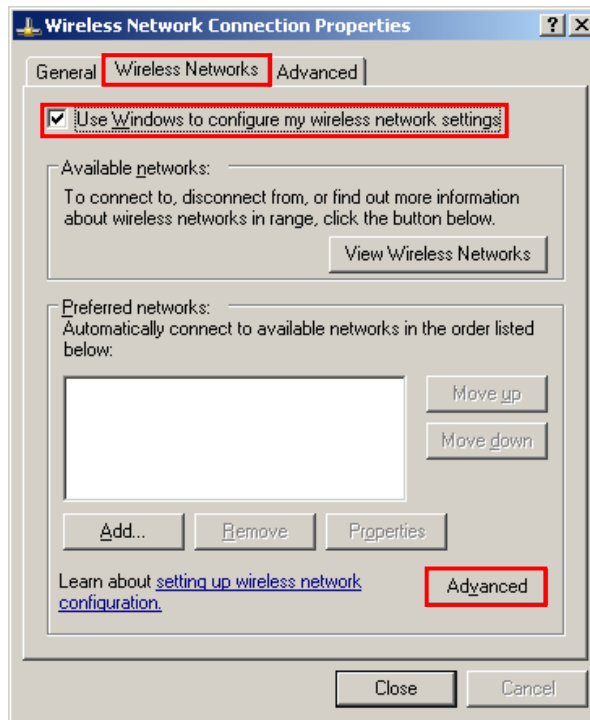

Click the “Advanced” button.

6) Select “Computer-to-computer (ad hoc) network only.”

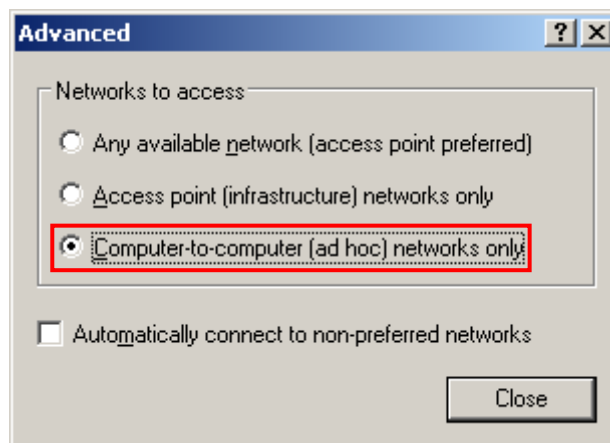

7) Click the “Add” button.

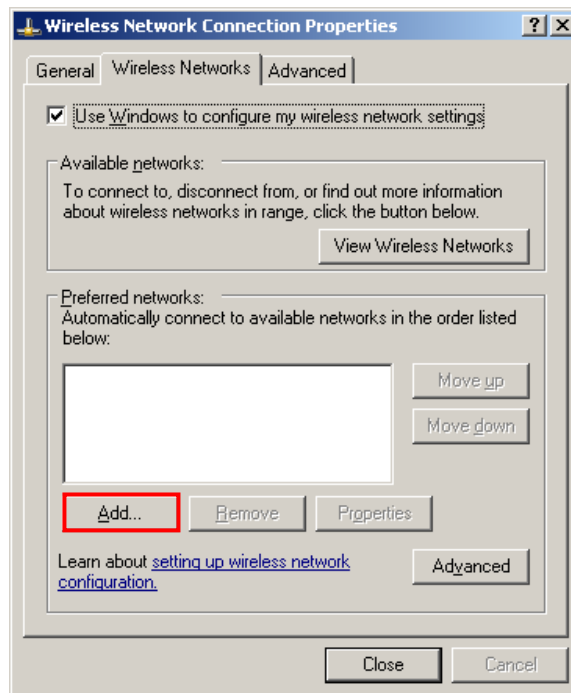

8) Enter “BIXOLON_adhoc” as the Network name (SSID).

Network Authentication: Select Open

Data Encryption: Select Disabled

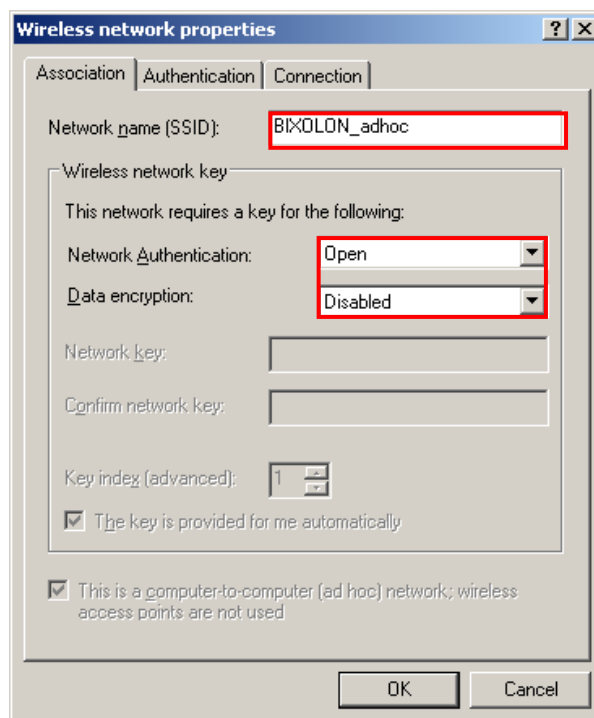

Click the “OK” button.

9) Click the “Connect” tab and check “Connect when this network is in range.”

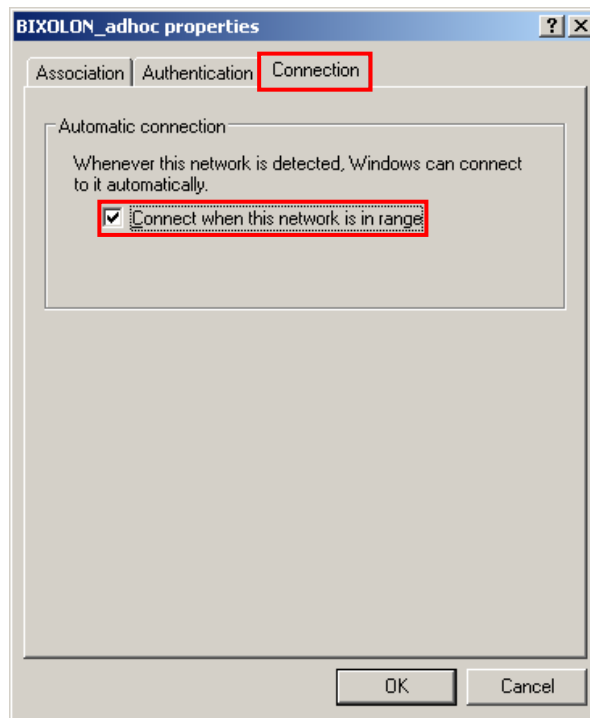

10) Check whether the settings are updated as shown below, and then click “Close”

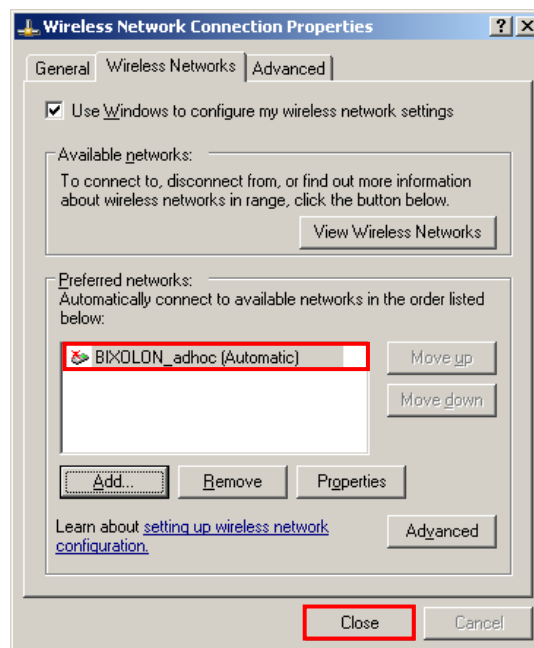

When the printer is set to the default value (Adhoc mode, SSID: BIXOLON_adhoc), it will automatically connect.

6-3 Initial Wireless LAN Connection (Windows VISTA, Windows 7, 8, 10)

When wireless utility program is installed, you have to set the wireless control values via the program, otherwise you have to terminate the program in order to do proper setting after following the steps “Control Panel>>Administrative tools>>Services>>Wireless Zero Configuration>>Start”.

1) Click the “Start>>Control Panel”.

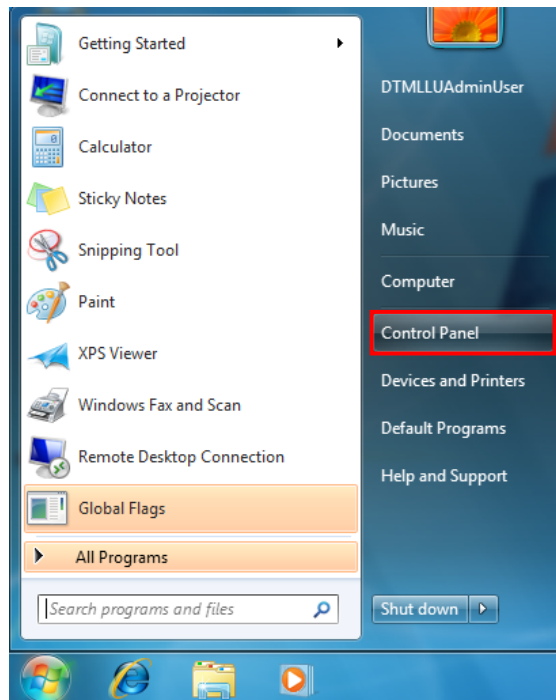

2) Click the “View network status and tasks”.

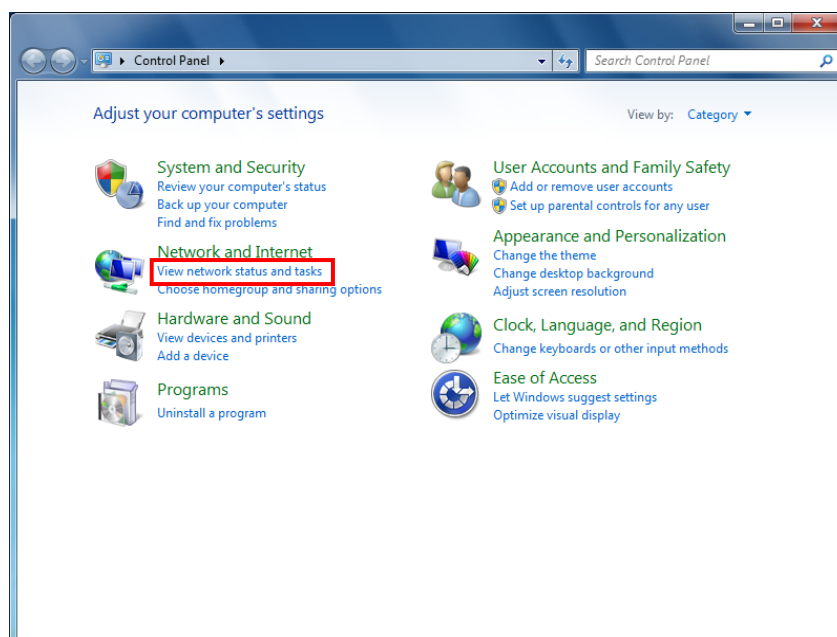

3) Click the “Change adapter settings”.

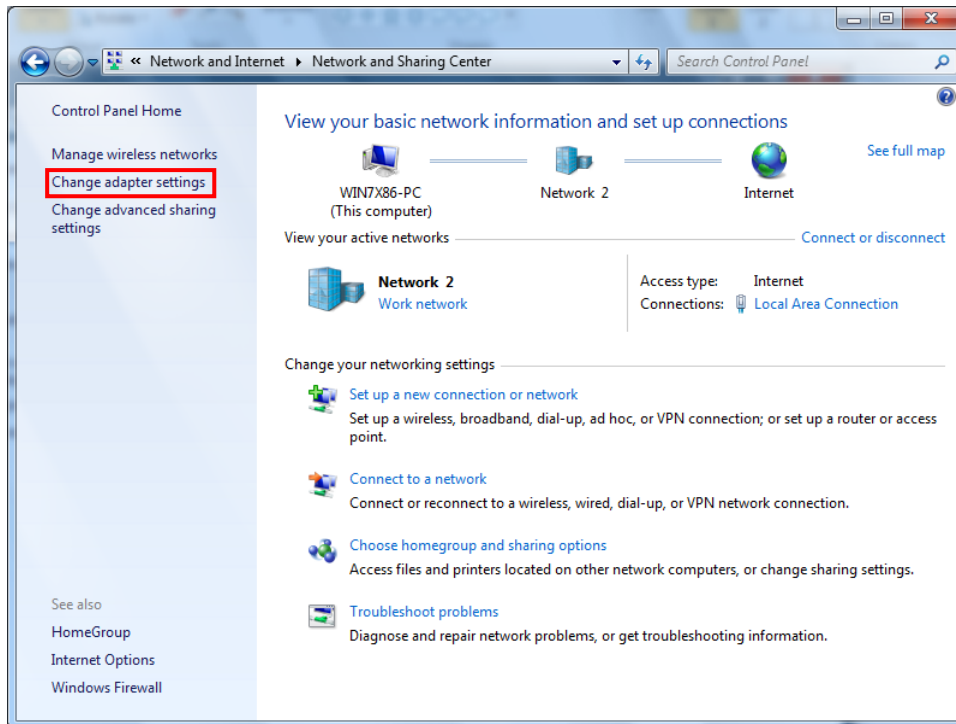

Click the “wireless network adaptor’s Properties”.

4) Select “Internet Protocol Version 4(TCP/IPv4)”, and then click “Properties”.

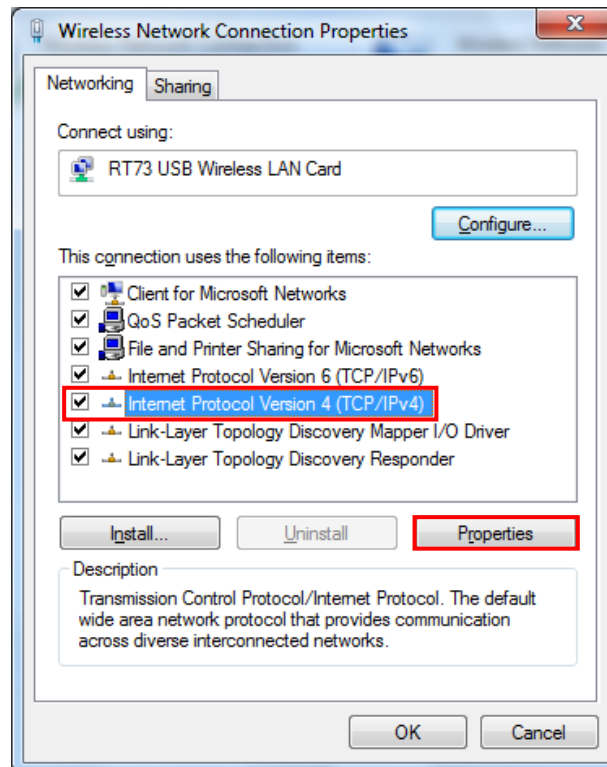

5) Set the IP settings as shown below, and then click “OK”.

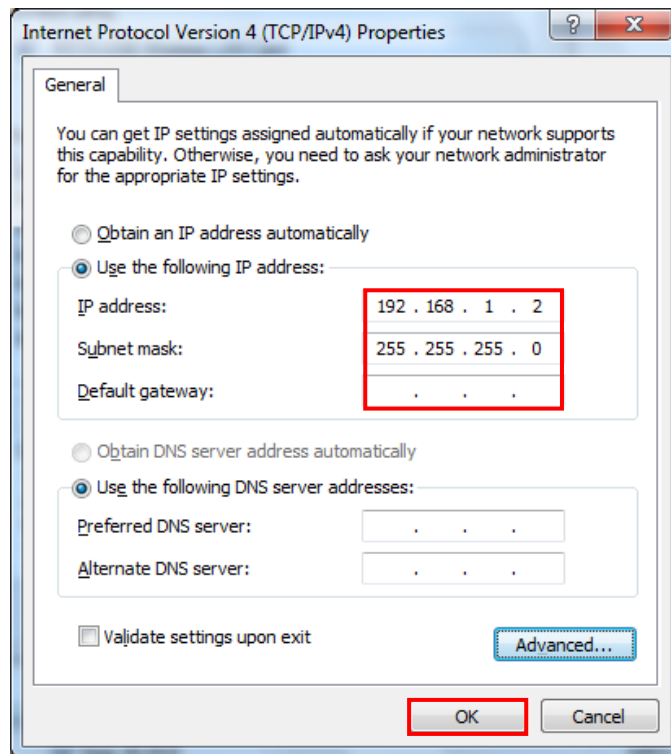

6) Click the “Manage wireless networks”.

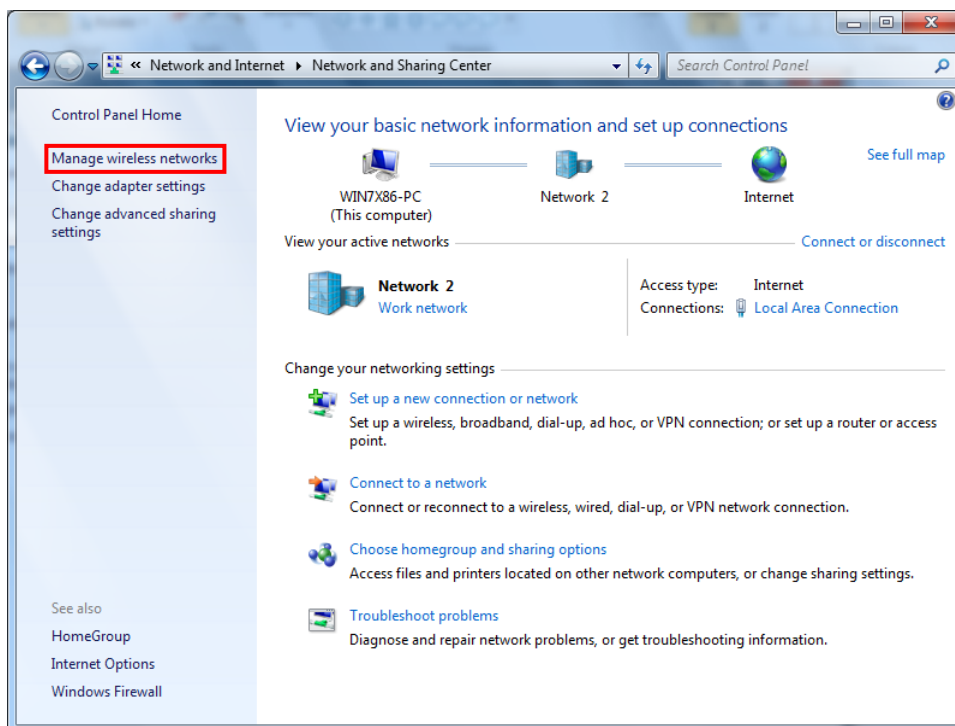

7) Click the “Add”.

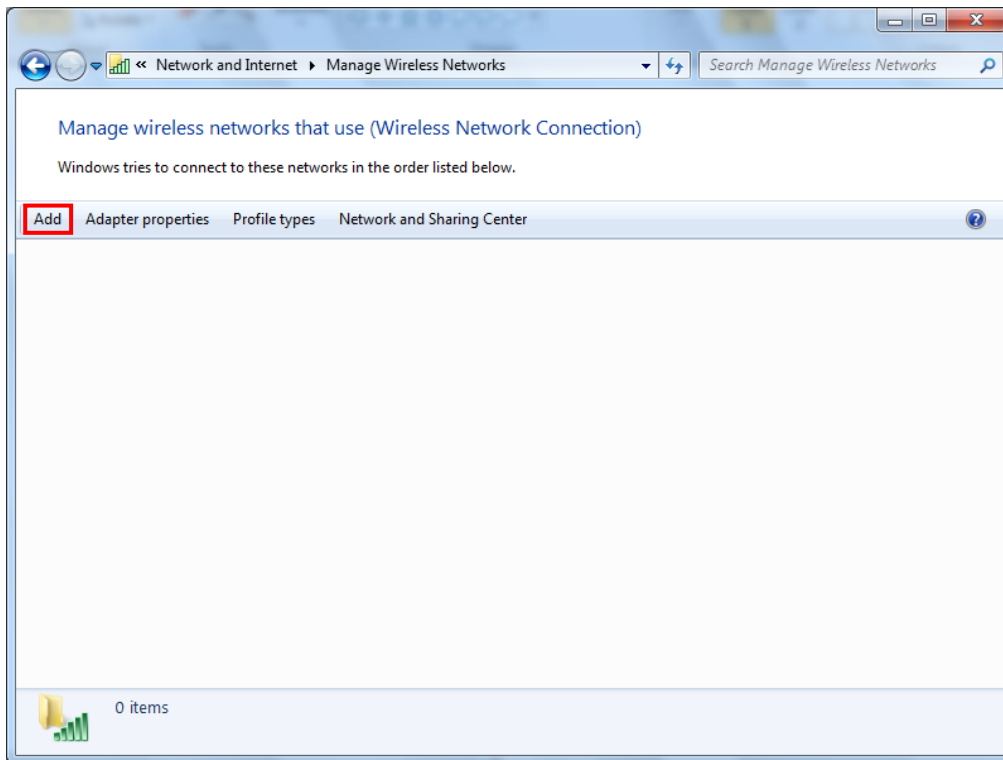

8) Click the “Create an ad hoc network”.

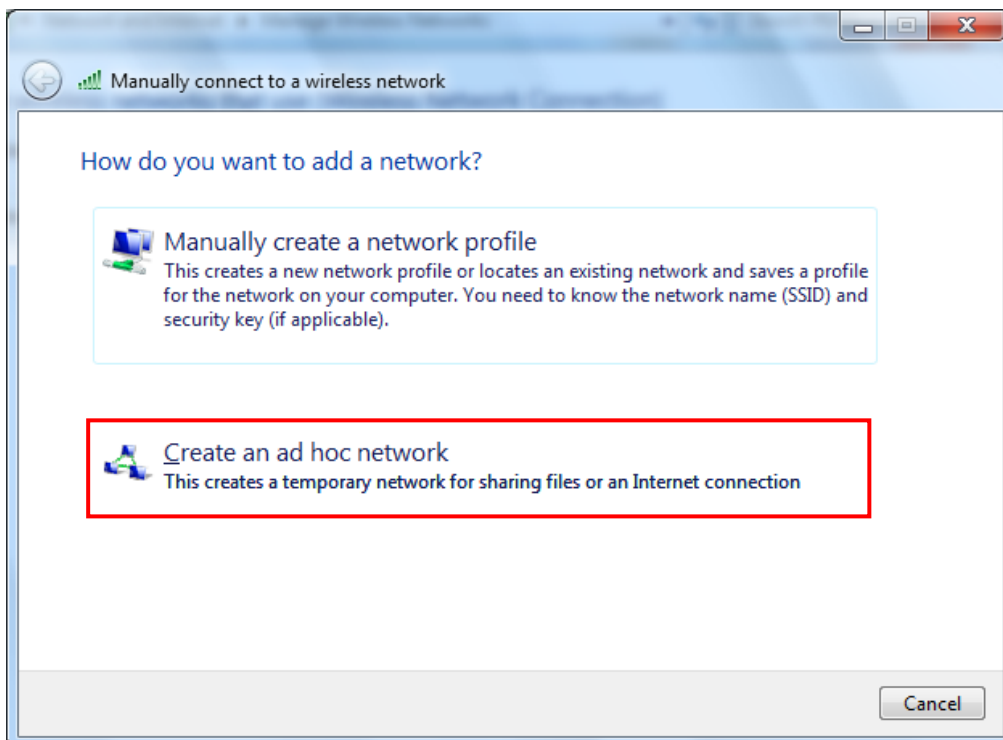

9) Click the “Next”.



10) “Network name” = BIXOLON_adhoc,
 “Security type” = Open,
 “Save this network” check, and then click the “Next”.

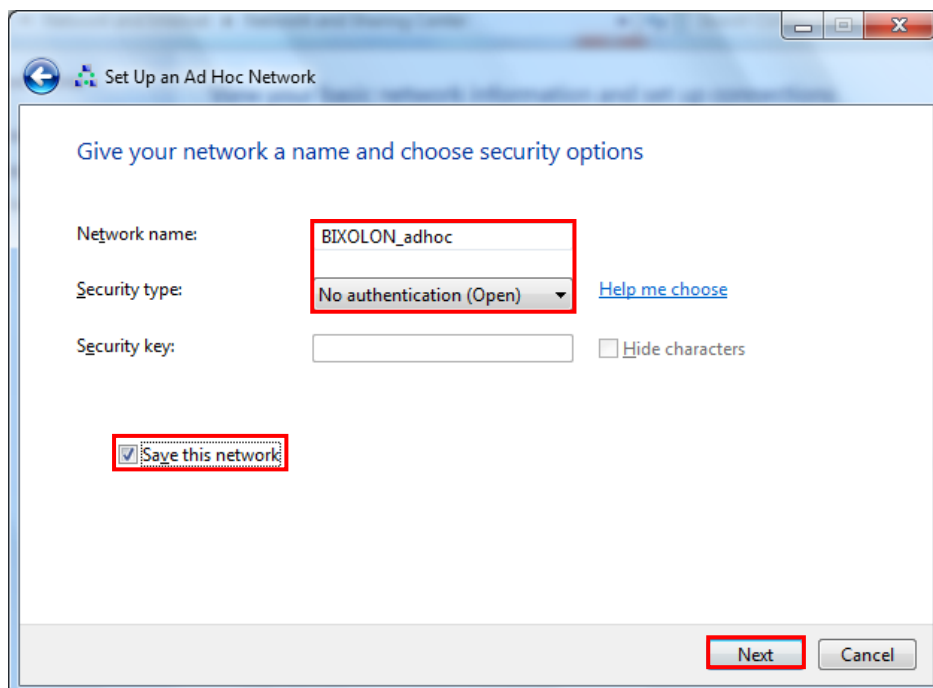

11) Click the “Close”.

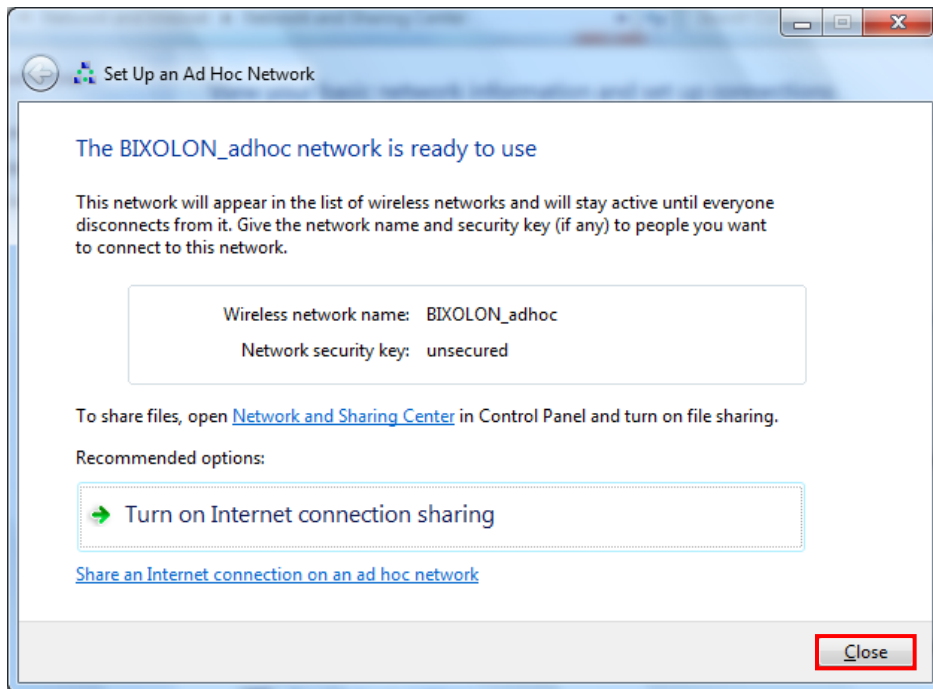

12) After completing configuration, Bixelon_adhoc network will be created.

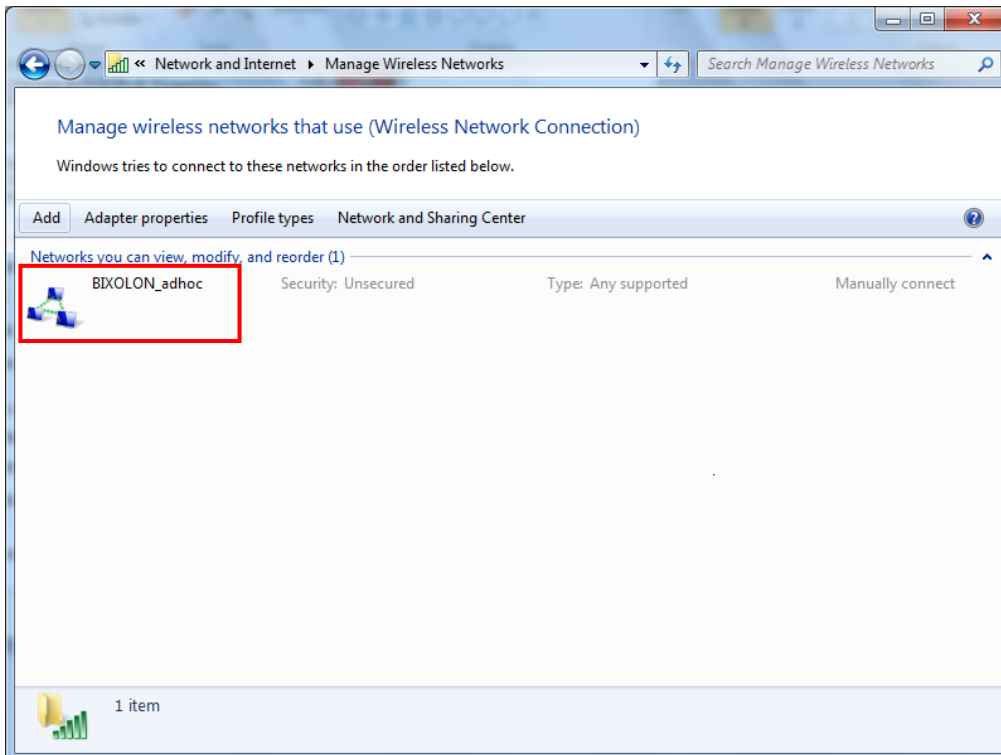

When the printer is set to the default value (Adhoc mode, SSID: BIXOLON_adhoc), it will automatically connect.

6-4 Initial Wireless LAN Connection (iOS)

1) Select "Wi-Fi".

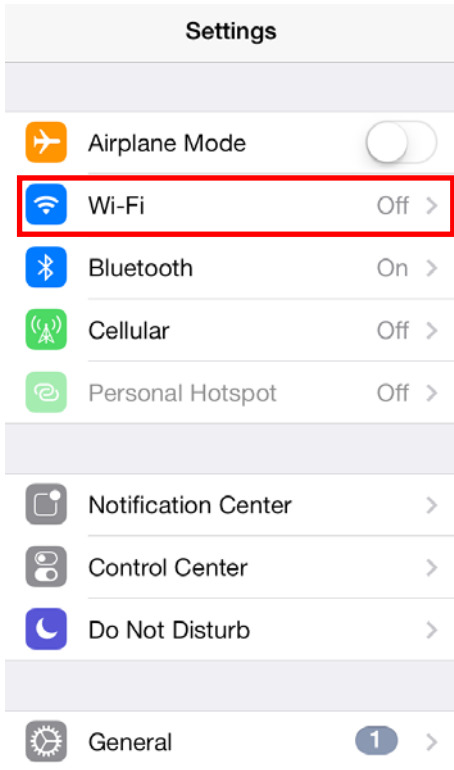

2) Wi-Fi ON and Select the printer to connect.

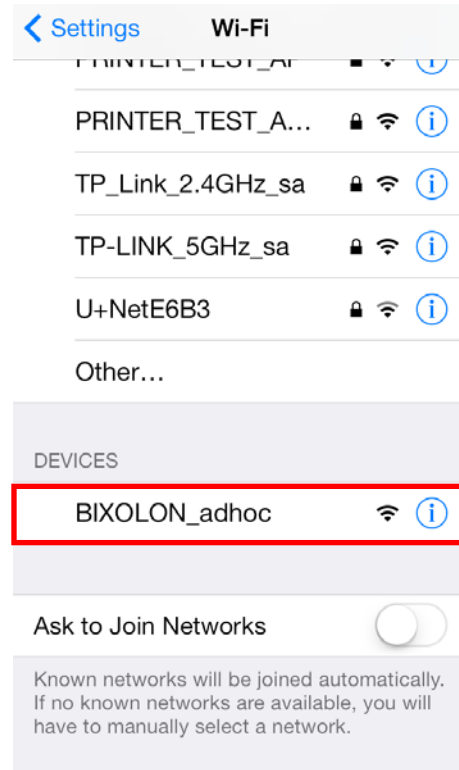

3) Wi-Fi communication is available.

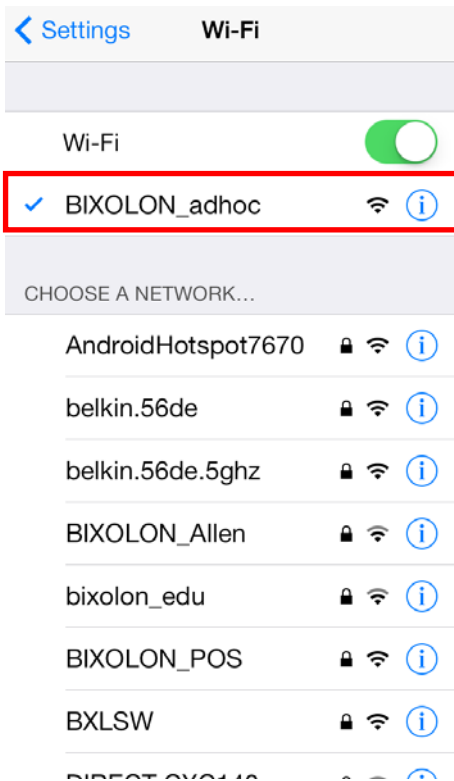

4) Set the network address.

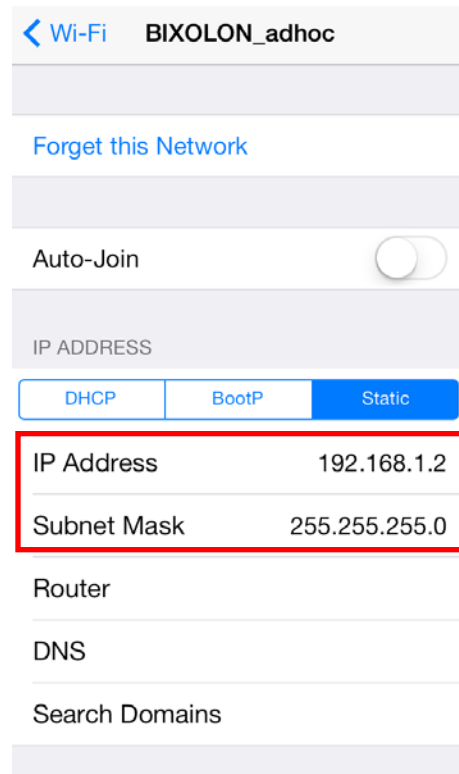

7. Configuration (B-gate only)

7-1 LAN Setting Values

Classification	Item	Remarks	Input Range
Home		LAN setting status display	
Network	Inactivity Time	TCP connection hold time	0~3600 integer(Sec)
	IP Assignment Method	IP assignment method	DHCP/Manual
	IP Address	Printer IP	IP Address
	Subnet Mask	Subnet mask	IP Address
	Gateway	Default Gateway	IP Address
	DNS	Domain name server IP	IP Address

7-2 WLAN Setting Values

Classification	Item	Remarks	Input Range
Home		WLAN setting status display	
Network	Network Mode	Wireless LAN operating mode	Infrastructure/Adhoc
	Adhoc Channel	Channel when creating Adhoc network	1~14
	SSID	ID of the AP to connect	1~32 letters
	Inactivity Time	TCP connection hold time	0~3600 integer
	IP Assignment Method	IP Assignment Method	DHCP/Manual
	IP Address	Printer IP	IP Address
	Subnet Mask	Subnet mask	IP Address
	Gateway	Default Gateway	IP Address
	DNS	Domain name server IP	IP Address
Authentication	Authentication	Wireless LAN authentication method	open, shared, wpa1/2-psk, wpa1/2
	Cryptograph	Wireless LAN encryption method	none,WEP64/128,TKIP,AES
	EAP Mode	Authentication method	none,PEAP,TLS,LEAP,FAST
	WEP Key	Key for WEP encryption method	WEP64 (5 Ascii, 10 Hex) WEP128 (13 Ascii, 26 Hex)
	PSK Key	Key for PSK encryption method	1~64 letters
	Authentication ID	ID for EAP Authentication	1~32 letters
	Authentication PW	Password for EAP Authentication	1~32 letters

7-3 Web Browser

When it comes to B-gate printer, it supports HTTP protocol for easy configuration over the web environment.

Enter the IP address of the B-gate in the address bar, and the following login window will pop up. Enter the ID and Password set for the B-gate, and then click “Log In” (Default setting values are ID: “admin”, Password: “Bgate”.)

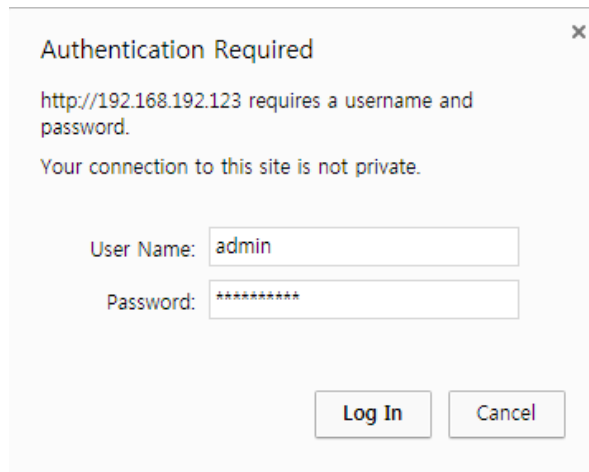

The image shows a standard Windows-style dialog box titled "Authentication Required". It contains the following text: "http://192.168.192.123 requires a username and password." and "Your connection to this site is not private." Below this text are two input fields: "User Name:" with the text "admin" entered, and "Password:" with a series of asterisks "*****" entered. At the bottom of the dialog are two buttons: "Log In" and "Cancel".

When the ID and Password match the ones registered in the B-gate, the following window will be opened.

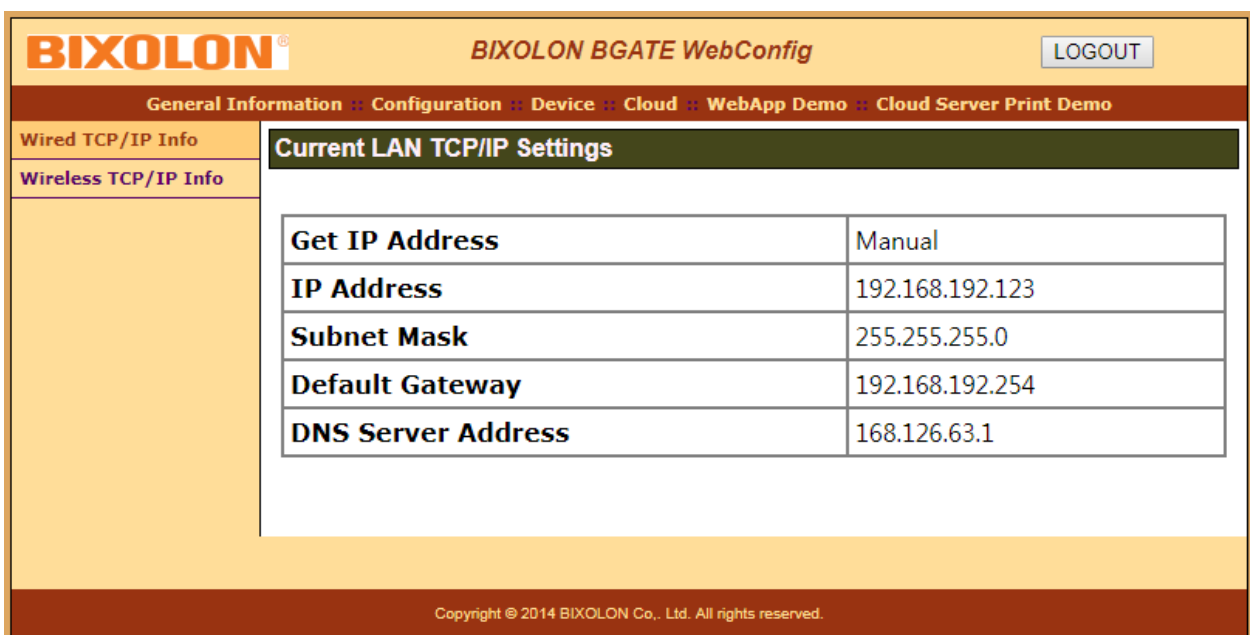

The image displays the BIXOLON BGATE WebConfig web interface. At the top, the BIXOLON logo is on the left, "BIXOLON BGATE WebConfig" is in the center, and a "LOGOUT" button is on the right. Below the header is a navigation menu with links: "General Information", "Configuration", "Device", "Cloud", "WebApp Demo", and "Cloud Server Print Demo". On the left side, there is a sidebar with "Wired TCP/IP Info" and "Wireless TCP/IP Info" options. The main content area is titled "Current LAN TCP/IP Settings" and contains a table with the following data:

Get IP Address	Manual
IP Address	192.168.192.123
Subnet Mask	255.255.255.0
Default Gateway	192.168.192.254
DNS Server Address	168.126.63.1

At the bottom of the interface, a copyright notice reads: "Copyright © 2014 BIXOLON Co., Ltd. All rights reserved."

Both LAN and WLAN can be configured from this window.

8. Network Status Check (B-gate only)

Provides network (WLAN, Ethernet, Bluetooth) Information.

- Method1) Push the below "Function Key" button
- Method2) Open the Printer Cover >> Push the Feed Button >> Close the Printer Cover >> Release the Feed Button

Note) It prints network information

(Example: controllable device list connected to USB port)

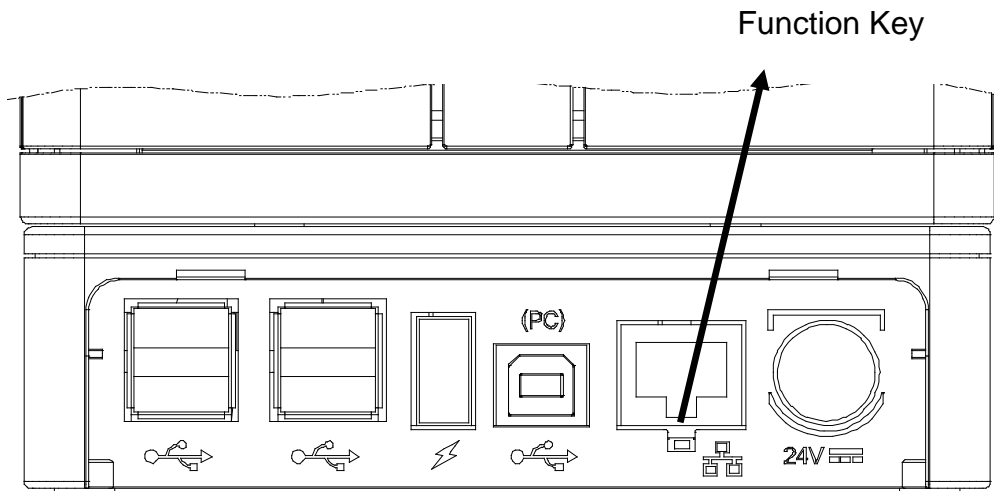

```

SRP-Q300 mPOS : V01.00 STB 052917
=====
[WLAN Configuration]
MAC Addr      : 84:16:f9:0c:84:67
Network       : adhoc
Auth          : open
Encrypt       : none
Essid         : BIXOLON_adhoc
Wlan_DHCP    : Disable
IP_Addr       : 192.168.1.1
Netmask       : 255.255.255.0
Gateway       : 192.168.1.2
Port          : 9100

[Ethernet Configuration]
MAC Addr      : 00:15:94:82:91:12
ETH_DHCP     : Disable
IP_Addr       : 192.168.192.123
Netmask       : 255.255.255.0
Gateway       : 192.168.192.254
Port          : 9100

[Bluetooth Configuration]
Device Name   : SRP-Q300
Firmware Version : 3.0.0
AUTH & ENCRY  : Enable
Connection Mode : 2
Auto Reconnect : Disable
Serial Number  : STDQ5KA17070001
PIN Code      : {Hidden}
    
```



MAC Addr : 74:F0:7D:B0:21:F0



* 7 4 F 0 7 D B 0 2 1 F 0 *

```

[Active USB Devices]
PRINTER-LOC      : VID.1504/PID.0086/10

[Cloud Server Print Configuration]
Allow            : Enable
Cloud Server     : cloud-bixelon.kr
Shop Name        : SHOP-BIXOLON
Serial Number    : STDQ5KA17070001
    
```



9. Troubleshooting (B-gate only)

When printing doesn't work

Check network setting

When using Ethernet

- IP Address

Check whether the IP Address band of the printer and the AP (or wireless terminals) are the same. The first three digits of the four digit value in the IP Address must be the same.

- Subnet Mask

Check whether the subnet mask of the printer matches with the one in AP (or wireless terminal).

- Port

Check whether the port configured in the printer and the host (PC, PDA) are the same.

When using WLAN

Check the wireless network setting of the AP and the printer.

(Refer to Configuration for checking/changing the printer settings)

- SSID

Check whether the SSID of the printer matches with the one in AP (or wireless terminal)

- 802.11 mode

Check whether the Protocol of the WLAN USB Adapter matches with the one in AP (or wireless terminal)

- Network Mode

Check the network mode of the printer.

Network mode must be set to "Infrastructure" to connect to AP and "Ad-hoc" to connect between wireless terminals.

- IP Address

Check the band of the IP Address.

Check whether the band of the printer and the AP (or wireless terminals) are the same.

The first three digits of the four digit value of the IP address must be the same.

- Subnet Mask

Check whether the subnet mask of the printer matches the one in AP (or wireless terminal).

- Port
Check whether the port configured in the printer and the host (PC, PDA) are the same.
- Authentication / Encryption
Check the authentication/encryption setting status.
Check whether the settings of the printer and the AP (wireless terminals) are the same.

PING Check

Checking IP collision

- When entering IP address manually without using DHCP, you must check whether the corresponding IP address is used by other equipment. The printer may not work normally when there is a collision in the IP address.
- When the printer is turned off, carry out the Ping Test to the printer IP.

Ping TEST

- Turn off the printer.
- Select "Run" from the Windows Start menu, and then enter "cmd".
- Enter "ARP -d" and delete ARP table.
- Enter "ping {printer IP}".
- ARP -d, ping {IP address}

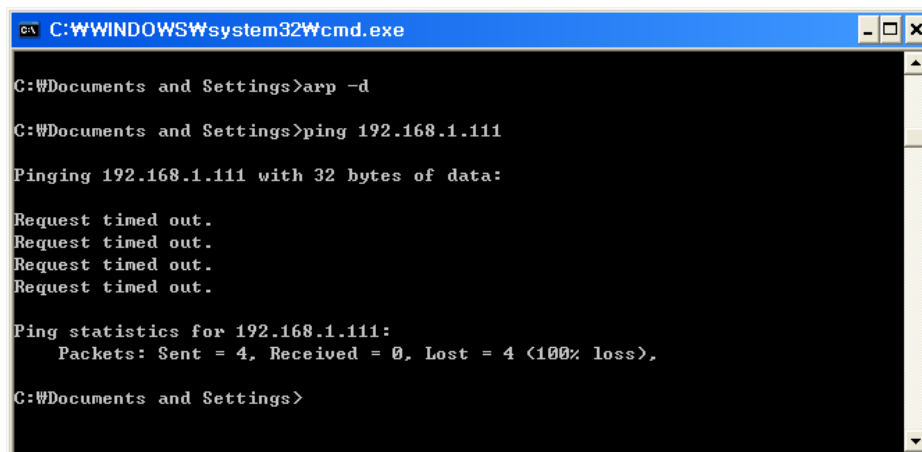

```
C:\WINDOWS\system32\cmd.exe
C:\Documents and Settings>arp -d
C:\Documents and Settings>ping 192.168.1.111
Pinging 192.168.1.111 with 32 bytes of data:
Request timed out.
Request timed out.
Request timed out.
Request timed out.
Ping statistics for 192.168.1.111:
    Packets: Sent = 4, Received = 0, Lost = 4 (100% loss),
C:\Documents and Settings>
```

When you see "Request timed out." as shown below, it means that there is no collision. The corresponding IP can be used.

On the other hand, if there is a reply as shown below, then the corresponding IP is used by another network terminal and it cannot be used for the printer IP.

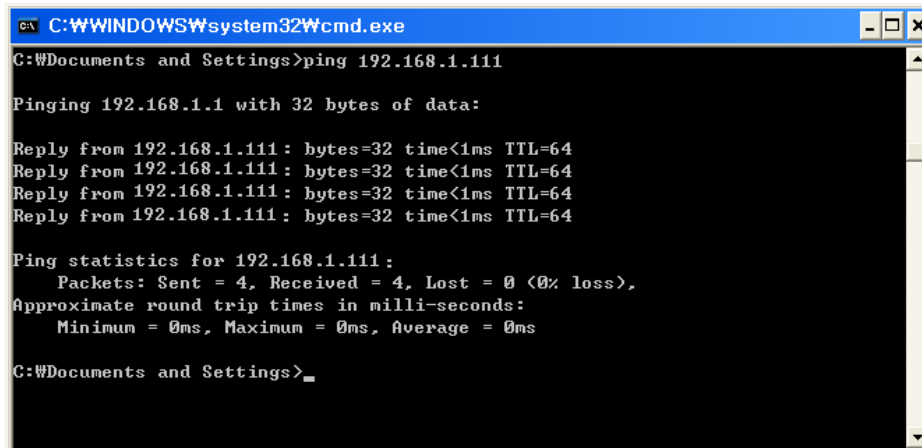

```
C:\WINDOWS\system32\cmd.exe
C:\Documents and Settings>ping 192.168.1.111

Pinging 192.168.1.1 with 32 bytes of data:

Reply from 192.168.1.111: bytes=32 time<1ms TTL=64
Reply from 192.168.1.111: bytes=32 time<1ms TTL=64
Reply from 192.168.1.111: bytes=32 time<1ms TTL=64
Reply from 192.168.1.111: bytes=32 time<1ms TTL=64

Ping statistics for 192.168.1.111:
    Packets: Sent = 4, Received = 4, Lost = 0 (0% loss),
    Approximate round trip times in milli-seconds:
        Minimum = 0ms, Maximum = 0ms, Average = 0ms

C:\Documents and Settings>_
```

Check Cable

When using Ethernet

- In order to check whether the problem is due to the LAN cable, connect the cable connected to the printer to other terminals or the PC to confirm whether its operation is normal.

When using WLAN

- It is recommended to use the USB extended cable provided by BIXOLON.
- Connect the USB extended cable and WLAN dongle to other terminals.