

BIXOLON®

Code Pages

SRP-330II/332II

Thermal Printer

Rev. 1.00

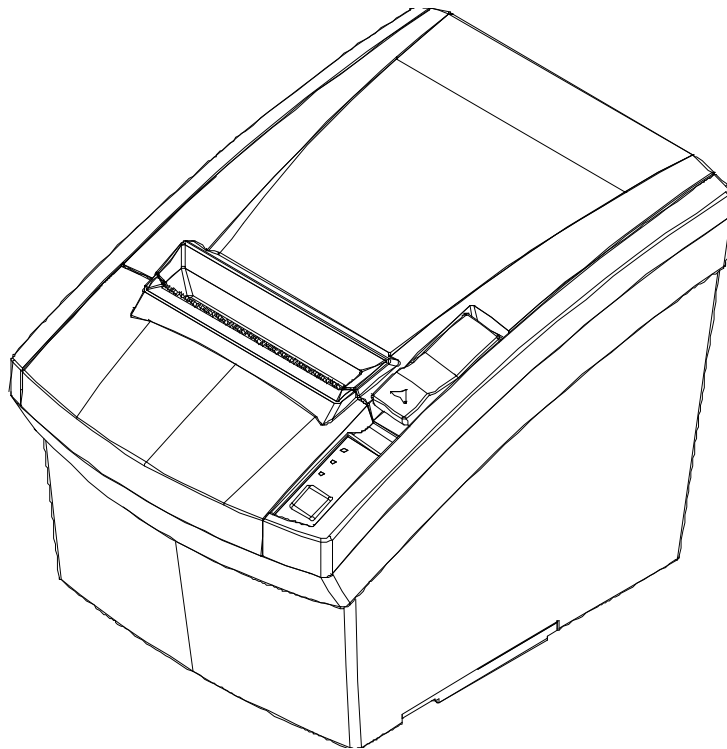

<http://www.bixolon.com>

■ Table of Contents

1. Notice..... 3
2. Page 0 - 437 (USA, Standard Europe)..... 3
3. Page 1 - Katakana 4
4. Page 2 - 850 (Multilingual) 5
5. Page 3 - 860 (Portuguese)..... 6
6. Page 4 - 863 (Canadian-French) 7
7. Page 5 - 865 (Nordic)..... 8
8. Page 16 - 1252 (Latin I) 9
9. Page 17 - 866 (Cyrillic #2) 10
10. Page 18 - 852 (Latin 2) 11
11. Page 19 - 858 (Euro) 12
12. Page 21 - 862 (Hebrew DOS code) 13
13. Page 22 - 864 (Arabic)..... 14
14. Page 23 - Thai character code 42..... 15
15. Page 24 - 1253 (Greek) 16
16. Page 25 - 1254 (Turkish) 17
17. Page 26 - 1257 (Baltic) 18
18. Page 27 - Farsi 19
19. Page 28 - 1251 (Cyrillic) 20
20. Page 29 - 737 (Greek) 21
21. Page 30 - 775 (Baltic) 22
22. Page 31 - Thai character code 14..... 23
23. Page 32 - Hebrew Old code..... 24
24. Page 33 - 1255 (Hebrew New code)..... 25
25. Page 34 - Thai character code 11 26
26. Page 35 - Thai character code 18..... 27
27. Page 36 - 855 (Cyrillic) 28
28. Page 37 - 857 (Turkish) 29
29. Page 38 - 928 (Greek) 30
30. Page 39 - Thai 16 31
31. Page 40 - 1256 (Arabic)..... 32
32. Page 41 - 1258 (Vietnam)..... 33
33. Page 42 - Khmer (Cambodia) 34
34. Page 47 - 1250 (Czech)..... 35
35. Page 48 - TCVN-3 36
36. Page 48 - TCVN-3 (Capital)..... 37
37. International character code table..... 38

1. Notice

The following pages show the character code tables. To find the character corresponding to a hexadecimal number, count across the top of the table for the left digit and count down the left column of the table for the right digit.

For example, 4A = J. (Page 0)

2. Page 0 - 437 (USA, Standard Europe)

HEX	HEX	0	1	2	3	4	5	6	7	8	9	A	B	C	D	E	F
HEX	BIN	0000	0001	0010	0011	0100	0101	0110	0111	1000	1001	1010	1011	1100	1101	1110	1111
0	0000	NUL	DLE	SP	0	@	P	`	p	Ç	É	á	⌘	⌘	α	≡	
		00	16	32	48	64	80	96	112	128	144	160	176	192	208	224	240
1	0001		!	1	A	Q	a	q	ù	æ	í	⌘	⌘	β	±		
		01	17	33	49	65	81	97	113	129	145	161	177	193	209	225	241
2	0010		"	2	B	R	b	r	é	Æ	ó	⌘	⌘	Γ	≥		
		02	18	34	50	66	82	98	114	130	146	162	178	194	210	226	242
3	0011		#	3	C	S	c	s	â	ô	ú	⌘	⌘	π	≤		
		03	19	35	51	67	83	99	115	131	147	163	179	195	211	227	243
4	0100	EOT	\$	4	D	T	d	t	ä	ö	ñ	⌘	⌘	Σ	ƒ		
		04	20	36	52	68	84	100	116	132	148	164	180	196	212	228	244
5	0101	ENQ	%	5	E	U	e	u	à	ò	Ñ	⌘	⌘	σ	Ƶ		
		05	21	37	53	69	85	101	117	133	149	165	181	197	213	229	245
6	0110		&	6	F	V	f	v	â	û	ª	⌘	⌘	μ	÷		
		06	22	38	54	70	86	102	118	134	150	166	182	198	214	230	246
7	0111		'	7	G	W	g	w	ç	ù	º	⌘	⌘	τ	≈		
		07	23	39	55	71	87	103	119	135	151	167	183	199	215	231	247
8	1000	BS	CAN	(8	H	X	h	x	ê	ÿ	ı	⌘	⌘	ϕ	°	
		08	24	40	56	72	88	104	120	136	152	168	184	200	216	232	248
9	1001	HT)	9	I	Y	i	y	ë	Ö	ƒ	⌘	⌘	⌘	θ	•	
		09	25	41	57	73	89	105	121	137	153	169	185	201	217	233	249
A	1010	LF	*	:	J	Z	j	z	è	Ü	ƒ	⌘	⌘	⌘	Ω	•	
		10	26	42	58	74	90	106	122	138	154	170	186	202	218	234	250
B	1011		ESC	+	;	K	[k	{	ı	¢	1/2	⌘	⌘	■	δ	√
		11	27	43	59	75	91	107	123	139	155	171	187	203	219	235	251
C	1100	FF	FS	,	<	L	\	l		î	£	1/4	⌘	⌘	■	∞	∞
		12	28	44	60	76	92	108	124	140	156	172	188	204	220	236	252
D	1101	CR	GS	-	=	M]	m	}	ì	¥	ı	⌘	⌘	■	φ	²
		13	29	45	61	77	93	109	125	141	157	173	189	205	221	237	253
E	1110		.	>	N	^	n	~	Ä	Pt	«	⌘	⌘	⌘	■	ε	•
		14	30	46	62	78	94	110	126	142	158	174	190	206	222	238	254
F	1111		/	?	O	_	o	SP	Å	f	»	⌘	⌘	⌘	■	∩	SP
		15	31	47	63	79	95	111	127	143	159	175	191	207	223	239	255

3. Page 1 - Katakana

	HEX	8	9	A	B	C	D	E	F
HEX	BIN	1000	1001	1010	1011	1100	1101	1110	1111
0	0000	█ 128	┌ 144	SP 160	一 176	夕 192	ミ 208	二 224	× 240
1	0001	█ 129	└ 145	。 161	ア 177	チ 193	ム 209	ト 225	円 241
2	0010	█ 130	┌ 146	「 162	イ 178	ツ 194	メ 210	キ 226	年 242
3	0011	█ 131	└ 147	」 163	ウ 179	テ 195	モ 211	コ 227	月 243
4	0100	█ 132	┌ 148	、 164	エ 180	ト 196	ヤ 212	▲ 228	日 244
5	0101	█ 133	┌ 149	・ 165	オ 181	ナ 197	ユ 213	▲ 229	時 245
6	0110	█ 134	┌ 150	ヲ 166	カ 182	ニ 198	ヨ 214	▼ 230	分 246
7	0111	█ 135	┌ 151	ア 167	キ 183	ヌ 199	ラ 215	▼ 231	秒 247
8	1000	┌ 136	┌ 152	イ 168	ク 184	ネ 200	リ 216	♠ 232	千 248
9	1001	┌ 137	└ 153	ウ 169	ケ 185	ノ 201	ル 217	♥ 233	市 249
A	1010	┌ 138	┌ 154	エ 170	コ 186	ハ 202	レ 218	◆ 234	区 250
B	1011	┌ 139	└ 155	オ 171	サ 187	ヒ 203	ロ 219	♣ 235	町 251
C	1100	█ 140	┌ 156	ヤ 172	シ 188	フ 204	ワ 220	● 236	村 252
D	1101	█ 141	┌ 157	ユ 173	ス 189	ヘ 205	ン 221	○ 237	人 253
E	1110	█ 142	┌ 158	ヨ 174	セ 190	ホ 206	、 222	／ 238	■ 254
F	1111	└ 143	└ 159	ツ 175	ソ 191	マ 207	。 223	＼ 239	SP 255

4. Page 2 - 850 (Multilingual)

HEX	HEX BIN	8 1000	9 1001	A 1010	B 1011	C 1100	D 1101	E 1110	F 1111
0	0000	Ç 128	É 144	á 160	☐ 176	Ł 192	š 208	Ó 224	— 240
1	0001	ü 129	æ 145	í 161	☐ 177	⊥ 193	Đ 209	β 225	± 241
2	0010	é 130	Æ 146	ó 162	☐ 178	⊥ 194	Ê 210	Ô 226	= 242
3	0011	â 131	ô 147	ú 163	179	⊥ 195	Ë 211	Ò 227	3/4 243
4	0100	ä 132	ö 148	ñ 164	† 180	— 196	È 212	ö 228	¶ 244
5	0101	à 133	ò 149	Ñ 165	Á 181	+ 197	i 213	Õ 229	§ 245
6	0110	á 134	û 150	ª 166	Â 182	ã 198	í 214	μ 230	÷ 246
7	0111	ç 135	ù 151	º 167	À 183	Ã 199	î 215	þ 231	· 247
8	1000	ê 136	ÿ 152	¿ 168	© 184	Ł 200	ï 216	ƒ 232	° 248
9	1001	ë 137	Ö 153	® 169	≡ 185	ƒ 201	⌋ 217	Ú 233	¨ 249
A	1010	è 138	Ü 154	¬ 170	∥ 186	∥ 202	┌ 218	Û 234	• 250
B	1011	ï 139	ø 155	1/2 171	∩ 187	∩ 203	■ 219	Ù 235	¹ 251
C	1100	î 140	£ 156	1/4 172	∩ 188	∩ 204	■ 220	Ý 236	³ 252
D	1101	ì 141	Ø 157	ı 173	¢ 189	= 205	ı 221	Ý 237	² 253
E	1110	Ä 142	X 158	« 174	¥ 190	† 206	ı 222	— 238	▪ 254
F	1111	Å 143	f 159	» 175	∩ 191	☉ 207	■ 223	´ 239	SP 255

5. Page 3 - 860 (Portuguese)

	HEX	8	9	A	B	C	D	E	F
HEX	BIN	1000	1001	1010	1011	1100	1101	1110	1111
0	0000	Ç 128	É 144	á 160	☐ 176	ℒ 192	⊥ 208	α 224	≡ 240
1	0001	ü 129	À 145	í 161	☐ 177	⊥ 193	⊥ 209	β 225	± 241
2	0010	é 130	È 146	ó 162	☐ 178	⊥ 194	⊥ 210	Γ 226	≥ 242
3	0011	â 131	ô 147	ú 163	 179	⊥ 195	⊥ 211	π 227	≤ 243
4	0100	ã 132	õ 148	ñ 164	⊥ 180	— 196	⊥ 212	Σ 228	f 244
5	0101	à 133	ò 149	Ñ 165	⊥ 181	⊥ 197	⊥ 213	σ 229	J 245
6	0110	Á 134	Ú 150	ã 166	⊥ 182	⊥ 198	⊥ 214	μ 230	÷ 246
7	0111	ç 135	ù 151	º 167	⊥ 183	⊥ 199	⊥ 215	τ 231	≈ 247
8	1000	ê 136	ì 152	¿ 168	⊥ 184	⊥ 200	⊥ 216	Φ 232	° 248
9	1001	Ê 137	Õ 153	Ò 169	⊥ 185	⊥ 201	⊥ 217	θ 233	• 249
A	1010	è 138	Ü 154	¬ 170	⊥ 186	⊥ 202	⊥ 218	Ω 234	• 250
B	1011	í 139	ç 155	1/2 171	⊥ 187	⊥ 203	■ 219	δ 235	√ 251
C	1100	Ô 140	£ 156	1/4 172	⊥ 188	⊥ 204	■ 220	∞ 236	n 252
D	1101	ì 141	Ù 157	i 173	⊥ 189	= 205	■ 221	φ 237	² 253
E	1110	Ã 142	Pt 158	« 174	⊥ 190	⊥ 206	■ 222	ε 238	▪ 254
F	1111	Â 143	Ó 159	» 175	⊥ 191	⊥ 207	■ 223	∩ 239	SP 255

6. Page 4 - 863 (Canadian-French)

HEX	HEX BIN	8 1000	9 1001	A 1010	B 1011	C 1100	D 1101	E 1110	F 1111
0	0000	Ç 128	É 144	Ï 160	Ë 176	Ł 192	ǀ 208	α 224	≡ 240
1	0001	ü 129	È 145	í 161	ë 177	ł 193	ǁ 209	β 225	± 241
2	0010	é 130	Ê 146	ó 162	ï 178	Ł 194	ǂ 210	Γ 226	≥ 242
3	0011	â 131	ô 147	ú 163	ï 179	ł 195	ǃ 211	π 227	≤ 243
4	0100	Â 132	Ë 148	ï 164	ı 180	— 196	Ǆ 212	Σ 228	f 244
5	0101	à 133	İ 149	ˆ 165	ı 181	+ 197	F 213	σ 229	J 245
6	0110	¶ 134	û 150	³ 166	ı 182	ƒ 198	ǅ 214	μ 230	÷ 246
7	0111	ç 135	ù 151	— 167	ı 183	ƒ 199	ǆ 215	τ 231	≈ 247
8	1000	ê 136	œ 152	î 168	ı 184	Ł 200	Ǉ 216	Φ 232	° 248
9	1001	ë 137	Ô 153	ı 169	ı 185	ǁ 201	ǈ 217	θ 233	• 249
A	1010	è 138	Ü 154	ı 170	ı 186	ǂ 202	ǉ 218	Ω 234	• 250
B	1011	ï 139	ø 155	1/2 171	ı 187	ǃ 203	■ 219	δ 235	√ 251
C	1100	î 140	£ 156	1/4 172	ı 188	Ǆ 204	■ 220	∞ 236	n 252
D	1101	= 141	Ù 157	3/4 173	ı 189	= 205	ı 221	φ 237	² 253
E	1110	À 142	Û 158	« 174	ı 190	ǅ 206	ı 222	ε 238	▪ 254
F	1111	§ 143	f 159	» 175	ı 191	ǆ 207	■ 223	∩ 239	SP 255













































7. Page 5 - 865 (Nordic)

HEX	HEX BIN	8 1000	9 1001	A 1010	B 1011	C 1100	D 1101	E 1110	F 1111
0	0000	Ç 128	É 144	á 160	☐ 176	ℒ 192	⌌ 208	α 224	≡ 240
1	0001	Û 129	æ 145	í 161	☐ 177	⊥ 193	⌌ 209	β 225	± 241
2	0010	é 130	Æ 146	ó 162	☐ 178	⌌ 194	⌌ 210	Γ 226	≥ 242
3	0011	â 131	ô 147	ú 163	179	⌌ 195	⌌ 211	π 227	≤ 243
4	0100	ä 132	ö 148	ñ 164	⌌ 180	— 196	⌌ 212	Σ 228	f 244
5	0101	à 133	ò 149	Ñ 165	⌌ 181	⌌ 197	⌌ 213	σ 229	J 245
6	0110	å 134	û 150	ä 166	⌌ 182	⌌ 198	⌌ 214	μ 230	÷ 246
7	0111	ç 135	ù 151	ø 167	⌌ 183	⌌ 199	⌌ 215	τ 231	≈ 247
8	1000	ê 136	ÿ 152	¿ 168	⌌ 184	⌌ 200	⌌ 216	Φ 232	° 248
9	1001	ë 137	Ö 153	⌌ 169	⌌ 185	⌌ 201	⌌ 217	θ 233	• 249
A	1010	è 138	Ü 154	⌌ 170	⌌ 186	⌌ 202	⌌ 218	Ω 234	• 250
B	1011	ï 139	ø 155	1/2 171	⌌ 187	⌌ 203	■ 219	δ 235	√ 251
C	1100	î 140	£ 156	1/4 172	⌌ 188	⌌ 204	■ 220	∞ 236	n 252
D	1101	ì 141	Ø 157	i 173	⌌ 189	= 205	■ 221	φ 237	z 253
E	1110	Ä 142	Pt 158	« 174	⌌ 190	⌌ 206	■ 222	ε 238	▪ 254
F	1111	Å 143	f 159	⊘ 175	⌌ 191	⌌ 207	■ 223	∩ 239	SP 255



8. Page 16 - 1252 (Latin I)

	HEX	8	9	A	B	C	D	E	F
HEX	BIN	1000	1001	1010	1011	1100	1101	1110	1111
0	0000	€ 128			° 176	À 192	Ð 208	à 224	đ 240
1	0001		‘ 145	í 161	± 177	Á 193	Ñ 209	á 225	ñ 241
2	0010	, 130	, 146	¢ 162	2 178	Â 194	Ò 210	â 226	ò 242
3	0011	f 131	“ 147	£ 163	3 179	Ã 195	Ó 211	ã 227	ó 243
4	0100	” 132	” 148	¤ 164	´ 180	Ä 196	Ô 212	ä 228	ô 244
5	0101	… 133	• 149	¥ 165	µ 181	Å 197	Õ 213	å 229	ö 245
6	0110	† 134	- 150	 166	¶ 182	Æ 198	Ö 214	æ 230	ö 246
7	0111	‡ 135	- 151	§ 167	• 183	Ç 199	× 215	ç 231	÷ 247
8	1000	^ 136	~ 152	" 168	· 184	È 200	Ø 216	è 232	ø 248
9	1001	‰ 137	™ 153	© 169	1 185	É 201	Ù 217	é 233	ù 249
A	1010	Š 138	š 154	à 170	ó 186	Ê 202	Ú 218	ê 234	ú 250
B	1011	‹ 139	› 155	« 171	» 187	Ë 203	Û 219	ë 235	û 251
C	1100	Œ 140	œ 156	¬ 172	¼ 188	Ì 204	Ü 220	ì 236	ü 252
D	1101			- 173	½ 189	Í 205	Ý 221	í 237	ý 253
E	1110	Ž 142	ž 158	® 174	¾ 190	Î 206	Þ 222	î 238	þ 254
F	1111		ÿ 159	- 175	¿ 191	Ï 207	ß 223	ï 239	ÿ 255

9. Page 17 - 866 (Cyrillic #2)

	HEX	8	9	A	B	C	D	E	F
HEX	BIN	1000	1001	1010	1011	1100	1101	1110	1111
0	0000	А 128	Р 144	а 160	 176	Л 192	 208	р 224	Ё 240
1	0001	Б 129	С 145	б 161	 177	 193	 209	с 225	ё 241
2	0010	В 130	Т 146	в 162	 178	 194	 210	т 226	ѐ 242
3	0011	Г 131	У 147	г 163	 179	 195	 211	у 227	ѓ 243
4	0100	Д 132	Ф 148	д 164	 180	— 196	 212	ф 228	ї 244
5	0101	Е 133	Х 149	е 165	 181	 197	 213	х 229	і 245
6	0110	Ж 134	Ц 150	ж 166	 182	 198	 214	ц 230	ÿ 246
7	0111	З 135	Ч 151	з 167	 183	 199	 215	ч 231	ÿ 247
8	1000	И 136	Ш 152	и 168	 184	 200	 216	ш 232	° 248
9	1001	Й 137	Щ 153	й 169	 185	 201	 217	щ 233	· 249
A	1010	К 138	Ъ 154	к 170	 186	 202	 218	ъ 234	· 250
B	1011	Л 139	Ы 155	л 171	 187	 203	 219	ы 235	√ 251
C	1100	М 140	Ь 156	м 172	 188	 204	 220	ь 236	№ 252
D	1101	Н 141	Э 157	н 173	 189	 205	 221	э 237	¤ 253
E	1110	О 142	Ю 158	о 174	 190	 206	 222	ю 238	 254
F	1111	П 143	Я 159	п 175	 191	 207	 223	я 239	SP 255

10. Page 18 - 852 (Latin 2)

	HEX	8	9	A	B	C	D	E	F
HEX	BIN	1000	1001	1010	1011	1100	1101	1110	1111
0	0000	Ç 128	É 144	á 160	 176	Ł 192	đ 208	Ó 224	- 240
1	0001	ü 129	Í 145	í 161	 177	⊥ 193	Đ 209	β 225	“ 241
2	0010	é 130	Í 146	ó 162	 178	⊥ 194	Đ 210	Ô 226	˘ 242
3	0011	â 131	ô 147	ú 163	 179	⊥ 195	Ě 211	Ń 227	ˇ 243
4	0100	ä 132	ö 148	À 164	⊥ 180	- 196	d' 212	ń 228	ˇ 244
5	0101	û 133	Ł 149	ą 165	Á 181	+ 197	Ň 213	ň 229	§ 245
6	0110	ć 134	ł 150	ž 166	Â 182	Ă 198	í 214	Š 230	+ 246
7	0111	ç 135	Ś 151	ž 167	Ě 183	ă 199	î 215	š 231	, 247
8	1000	ł 136	ś 152	Ę 168	Ş 184	Ł 200	ě 216	Ř 232	° 248
9	1001	ë 137	Ö 153	ę 169	⊥ 185	Ŕ 201	ǰ 217	Ú 233	“ 249
A	1010	Ő 138	Ü 154	˘ 170	 186	⊥ 202	Ŕ 218	í 234	· 250
B	1011	ő 139	Ť 155	Ž 171	⊥ 187	⊥ 203	■ 219	Ű 235	ú 251
C	1100	î 140	ť 156	Č 172	⊥ 188	Ŧ 204	■ 220	ý 236	Ř 252
D	1101	ž 141	ł 157	ş 173	Ž 189	= 205	Ŧ 221	Ý 237	ř 253
E	1110	Ă 142	x 158	« 174	ž 190	⊥ 206	Ű 222	ı 238	■ 254
F	1111	Ć 143	č 159	» 175	⊥ 191	⊥ 207	■ 223	˘ 239	 255

11. Page 19 - 858 (Euro)

HEX	HEX	8	9	A	B	C	D	E	F
HEX	BIN	1000	1001	1010	1011	1100	1101	1110	1111
0	0000	Ç 128	É 144	á 160	☐ 176	Ł 192	ö 208	Ó 224	— 240
1	0001	ü 129	æ 145	í 161	☐ 177	⊥ 193	Ɔ 209	β 225	± 241
2	0010	é 130	Æ 146	ó 162	☐ 178	⊥ 194	Ê 210	Ô 226	= 242
3	0011	â 131	ô 147	ú 163	 179	⊥ 195	Ë 211	Ò 227	3/4 243
4	0100	ä 132	ö 148	ñ 164	⊥ 180	— 196	È 212	õ 228	¶ 244
5	0101	à 133	ò 149	Ñ 165	Á 181	+ 197	€ 213	Õ 229	§ 245
6	0110	á 134	û 150	ª 166	À 182	ã 198	í 214	μ 230	÷ 246
7	0111	ç 135	ù 151	º 167	À 183	Ä 199	ï 215	þ 231	· 247
8	1000	ê 136	ÿ 152	¿ 168	© 184	Ł 200	ÿ 216	Ɔ 232	° 248
9	1001	ë 137	ö 153	® 169	≡ 185	Ɔ 201	⊥ 217	ú 233	· 249
A	1010	è 138	Ü 154	¬ 170	 186	⊥ 202	Ɔ 218	0 234	· 250
B	1011	ï 139	ø 155	1/2 171	⊥ 187	⊥ 203	■ 219	ù 235	1 251
C	1100	î 140	£ 156	1/4 172	⊥ 188	Ɔ 204	■ 220	ý 236	3 252
D	1101	ì 141	ø 157	ı 173	¢ 189	= 205	ı 221	Ý 237	2 253
E	1110	Ä 142	x 158	« 174	¥ 190	† 206	ı 222	— 238	■ 254
F	1111	Å 143	f 159	» 175	⊥ 191	α 207	■ 223	· 239	SP 255

12. Page 21 - 862 (Hebrew DOS code)

	HEX	8	9	A	B	C	D	E	F
HEX	BIN	1000	1001	1010	1011	1100	1101	1110	1111
0	0000	א 128	ב 144	א 160	☐ 176	ל 192	⌞ 208	α 224	≡ 240
1	0001	ב 129	ב 145	א 161	☐ 177	⌞ 193	⌞ 209	β 225	± 241
2	0010	ג 130	ג 146	א 162	☐ 178	⌞ 194	⌞ 210	Γ 226	≥ 242
3	0011	ד 131	ד 147	א 163	 179	⌞ 195	⌞ 211	π 227	≤ 243
4	0100	ה 132	פ 148	ñ 164	⌞ 180	— 196	⌞ 212	Σ 228	 244
5	0101	ו 133	ז 149	Ñ 165	⌞ 181	⌞ 197	⌞ 213	σ 229	⌞ 245
6	0110	ז 134	ח 150	a 166	⌞ 182	⌞ 198	⌞ 214	μ 230	÷ 246
7	0111	ח 135	ט 151	o 167	⌞ 183	⌞ 199	⌞ 215	τ 231	≈ 247
8	1000	ט 136	י 152	ı 168	⌞ 184	⌞ 200	⌞ 216	Φ 232	° 248
9	1001	י 137	יא 153	⌞ 169	⌞ 185	⌞ 201	⌞ 217	Θ 233	· 249
A	1010	יא 138	יב 154	⌞ 170	⌞ 186	⌞ 202	⌞ 218	Ω 234	· 250
B	1011	יב 139	⌞ 155	½ 171	⌞ 187	⌞ 203	■ 219	δ 235	√ 251
C	1100	יג 140	£ 156	¾ 172	⌞ 188	⌞ 204	■ 220	∞ 236	n 252
D	1101	יד 141	¥ 157	i 173	⌞ 189	⌞ 205	■ 221	φ 237	² 253
E	1110	יז 142	Pts 158	« 174	⌞ 190	⌞ 206	■ 222	ε 238	■ 254
F	1111	יח 143	f 159	» 175	⌞ 191	⌞ 207	■ 223	∩ 239	SP 255

13. Page 22 - 864 (Arabic)

HEX	HEX	8	9	A	B	C	D	E	F
HEX	BIN	1000	1001	1010	1011	1100	1101	1110	1111
0	0000	° 128	β 144	NBSP 160	· 176	¢ 192	ذ 208	- 224	ـ 240
1	0001	· 129	∞ 145	— 161	ٲ 177	ء 193	ر 209	ف 225	ـ 241
2	0010	· 130	∅ 146	آ 162	ٲ 178	آ 194	ز 210	ق 226	ن 242
3	0011	√ 131	± 147	£ 163	ٳ 179	أ 195	س 211	ك 227	هـ 243
4	0100	▒ 132	½ 148	¤ 164	ٴ 180	ؤ 196	ش 212	ل 228	هـ 244
5	0101	— 133	¼ 149	أ 165	هـ 181	ع 197	ص 213	م 229	ى 245
6	0110	 134	≈ 150	 166	ٶ 182	ئ 198	ض 214	ن 230	ي 246
7	0111	† 135	« 151	€ 167	ٷ 183	ا 199	ط 215	هـ 231	غ 247
8	1000	‡ 136	» 152	ا 168	ٸ 184	ب 200	ظ 216	و 232	ق 248
9	1001	‡ 137	لأ 153	ب 169	٩ 185	ة 201	ع 217	ى 233	لأ 249
A	1010	‡ 138	لأ 154	ت 170	ف 186	ت 202	غ 218	ي 234	لأ 250
B	1011	‡ 139	 155	ث 171	؛ 187	ث 203	ا 219	ض 235	ل 251
C	1100	⌋ 140	 156	، 172	س 188	ج 204	⌋ 220	ع 236	ك 252
D	1101	⌋ 141	لا 157	ج 173	ش 189	ح 205	÷ 221	غ 237	ي 253
E	1110	⌋ 142	لا 158	ح 174	ص 190	خ 206	× 222	غ 238	■ 254
F	1111	⌋ 143	لا 159	خ 175	؟ 191	د 207	ع 223	م 239	 255

14. Page 23 - Thai character code 42

	HEX	8	9	A	B	C	D	E	F
HEX	BIN	1000	1001	1010	1011	1100	1101	1110	1111
0	0000	┌ 128	○ 144	 160	ฅ 176	ย 192	๒ 208	' 224	๒๓ 240
1	0001	└ 129	๑ 145	ก 161	ฆ 177	ร 193	๓ 209	๑ 225	๒๔ 241
2	0010	└┐ 130	๒ 146	ข 162	ค 178	ถ 194	๔ 210	๒ 226	๒๕ 242
3	0011	└┘ 131	๓ 147	ค 163	ด 179	ล 195	๕ 211	๓ 227	๒๖ 243
4	0100	└┐ 132	๔ 148	ฅ 164	ถ 180	ว 196	๖ 212	๔ 228	๒๗ 244
5	0101	└┘ 133	๕ 149	ง 165	ท 181	ศ 197	๗ 213	๕ 229	๒๘ 245
6	0110	└┐ 134	๖ 150	จ 166	ธ 182	ษ 198	๘ 214	๖ 230	๒๙ 246
7	0111	└┘ 135	๗ 151	ฉ 167	น 183	ส 199	๙ 215	๗ 231	๓๐ 247
8	1000	└┐ 136	๘ 152	ช 168	บ 184	ห 200	๑๐ 216	๘ 232	๓๑ 248
9	1001	└┘ 137	๙ 153	ฅ 169	ป 185	ฬ 201	๑๑ 217	๙ 233	๓๒ 249
A	1010	└┐ 138	๑๐ 154	ฆ 170	ผ 186	อ 202	๑๒ 218	๑๐ 234	๓๓ 250
B	1011	█ 139	๑๑ 155	ง 171	ฝ 187	ฮ 203	๑๓ 219	๑๑ 235	๓๔ 251
C	1100	← 140	๑๒ 156	จ 172	พ 188	๕ 204	๑๔ 220	๑๒ 236	๓๕ 252
D	1101	↑ 141	๑๓ 157	ฉ 173	ฟ 189	ภ 205	๑๕ 221	๑๓ 237	๓๖ 253
E	1110	→ 142	๑๔ 158	ช 174	ภ 190	ก 206	๑๖ 222	๑๔ 238	๓๗ 254
F	1111	↓ 143	๑๕ 159	ซ 175	ม 191	ง 207	๑๗ 223	๑๕ 239	๓๘ 255

15. Page 24 - 1253 (Greek)

	HEX	8	9	A	B	C	D	E	F
HEX	BIN	1000	1001	1010	1011	1100	1101	1110	1111
0	0000	€ 128		NBSP 160	° 176	ı̇ 192	Π 208	ÿ 224	π 240
1	0001		‘ 145	“ 161	± 177	Α 193	Ρ 209	α 225	ρ 241
2	0010	, 130	, 146	À 162	² 178	Β 194		β 226	ς 242
3	0011	f 131	“ 147	£ 163	³ 179	Γ 195	Σ 211	ϣ 227	ο 243
4	0100	” 132	” 148	α 164	’ 180	Δ 196	Τ 212	δ 228	τ 244
5	0101	… 133	• 149	¥ 165	μ 181	Ε 197	Υ 213	ε 229	υ 245
6	0110	† 134	– 150	ı̇ 166	¶ 182	Ζ 198	Φ 214	ζ 230	φ 246
7	0111	‡ 135	— 151	§ 167	· 183	Η 199	Χ 215	η 231	χ 247
8	1000			“ 168	Ε 184	Θ 200	Ψ 216	θ 232	ψ 248
9	1001	‰ 137	™ 153	© 169	Η 185	Ι 201	Ω 217	ι 233	ω 249
A	1010				Ι 186	Κ 202	Ϊ 218	κ 234	ϊ 250
B	1011	< 139	> 155	« 171	» 187	Λ 203	Ϋ 219	λ 235	ϋ 251
C	1100			¬ 172	Ό 188	Μ 204	ά 220	μ 236	ό 252
D	1101			- 173	½ 189	Ν 205	έ 221	ν 237	ύ 253
E	1110			® 174	Υ 190	Ξ 206	ή 222	ξ 238	ώ 254
F	1111			— 175	Ω 191	Ο 207	ί 223	ο 239	



16. Page 25 - 1254 (Turkish)

	HEX	8	9	A	B	C	D	E	F
HEX	BIN	1000	1001	1010	1011	1100	1101	1110	1111
0	0000	€ 128		NBSP 160	° 176	À 192	Ğ 208	à 224	ğ 240
1	0001		‘ 145	ı 161	± 177	Á 193	Ñ 209	á 225	ñ 241
2	0010	, 130	, 146	¢ 162	² 178	Â 194	Ò 210	â 226	ò 242
3	0011	f 131	“ 147	£ 163	³ 179	Ã 195	Ó 211	ã 227	ó 243
4	0100	” 132	” 148	¤ 164	´ 180	Ä 196	Ô 212	ä 228	ô 244
5	0101	… 133	• 149	¥ 165	µ 181	Å 197	Õ 213	å 229	õ 245
6	0110	† 134	– 150	ı 166	¶ 182	Æ 198	Ö 214	æ 230	ö 246
7	0111	‡ 135	— 151	§ 167	· 183	Ç 199	× 215	ç 231	÷ 247
8	1000	^ 136	~ 152	¨ 168	¸ 184	È 200	Ø 216	è 232	ø 248
9	1001	‰ 137	™ 153	© 169	¹ 185	É 201	Ù 217	é 233	ù 249
A	1010	Š 138	š 154	ª 170	º 186	Ê 202	Ú 218	ê 234	ú 250
B	1011	‹ 139	› 155	« 171	» 187	Ë 203	Û 219	ë 235	û 251
C	1100	Œ 140	œ 156	¬ 172	¼ 188	Ì 204	Ü 220	ì 236	ü 252
D	1101			- 173	½ 189	Í 205	İ 221	í 237	ı 253
E	1110			® 174	¾ 190	Î 206	Ş 222	î 238	ş 254
F	1111		ÿ 159	¯ 175	¿ 191	Ï 207	ß 223	ï 239	ÿ 255

17. Page 26 - 1257 (Baltic)

	HEX	8	9	A	B	C	D	E	F
HEX	BIN	1000	1001	1010	1011	1100	1101	1110	1111
0	0000	€ 128		NBSP 160	° 176	À 192	Š 208	ą 224	š 240
1	0001		‘ 145		± 177	Ļ 193	Ņ 209	į 225	ń 241
2	0010	, 130	, 146	¢ 162	² 178	Ā 194	Ņ 210	ā 226	ņ 242
3	0011		“ 147	£ 163	³ 179	Č 195	Ó 211	ć 227	ó 243
4	0100	” 132	” 148	¤ 164	´ 180	Ä 196	Ö 212	ä 228	ö 244
5	0101	… 133	• 149		µ 181	Å 197	Õ 213	å 229	õ 245
6	0110	† 134	– 150	ı 166	¶ 182	Ę 198	Ö 214	ę 230	ö 246
7	0111	‡ 135	— 151	§ 167	· 183	Ē 199	× 215	ē 231	÷ 247
8	1000			Ø 168	ø 184	Č 200	Ų 216	č 232	ų 248
9	1001	‰ 137	™ 153	© 169	¹ 185	É 201	Ł 217	é 233	ł 249
A	1010			Ŕ 170	ŗ 186	Ž 202	Ś 218	ż 234	ś 250
B	1011	< 139	> 155	« 171	» 187	È 203	Ū 219	è 235	ū 251
C	1100			ƒ 172	¼ 188	Ģ 204	Ü 220	ģ 236	ü 252
D	1101	¨ 141	— 157	- 173	½ 189	Ķ 205	Ž 221	ķ 237	ž 253
E	1110	˘ 142	˙ 158	® 174	¾ 190	Ī 206	Ž 222	ī 238	ž 254
F	1111	˚ 143		Æ 175	æ 191	Ļ 207	ß 223	ļ 239	· 255



18. Page 27 - Farsi

	HEX	8	9	A	B	C	D	E	F
HEX	BIN	1000	1001	1010	1011	1100	1101	1110	1111
0	0000	۰ 128	ا 144	خ 160	 176	ل 192	ل 208	ظ 224	ک 240
1	0001	۱ 129	آ 145	ح 161	 177	ل 193	ل 209	ع 225	ل 241
2	0010	۲ 130	ب 146	د 162	 178	ل 194	ل 210	ع 226	لا 242
3	0011	۳ 131	ب 147	ذ 163	 179	ل 195	ل 211	ع 227	ل 243
4	0100	۴ 132	پ 148	ر 164	ل 180	— 196	ل 212	ع 228	م 244
5	0101	۵ 133	پ 149	ز 165	ل 181	ل 197	ل 213	غ 229	م 245
6	0110	۶ 134	ت 150	ث 166	ل 182	ل 198	ل 214	غ 230	ن 246
7	0111	۷ 135	ث 151	س 167	ل 183	ل 199	ل 215	غ 231	ن 247
8	1000	۸ 136	ث 152	س 168	ل 184	ل 200	ل 216	غ 232	و 248
9	1001	۹ 137	ث 153	ش 169	ل 185	ل 201	ل 217	فا 233	ه 249
A	1010	۰ 138	ج 154	ش 170	ل 186	ل 202	ل 218	فا 234	ه 250
B	1011	۱ 139	چ 155	ص 171	ل 187	ل 203	■ 219	ق 235	ه 251
C	1100	۲ 140	چ 156	ط 172	ل 188	ل 204	■ 220	قا 236	ی 252
D	1101	آ 141	چ 157	ض 173	ل 189	ل 205	■ 221	ک 237	ی 253
E	1110	ک 142	ح 158	ظ 174	ل 190	ل 206	■ 222	ک 238	پ 254
F	1111	۴ 143	ح 159	ط 175	ل 191	ل 207	■ 223	گ 239	

19. Page 28 - 1251 (Cyrillic)

	HEX	8	9	A	B	C	D	E	F
HEX	BIN	1000	1001	1010	1011	1100	1101	1110	1111
0	0000	Ғ 128	Һ 144	NBSP 160	° 176	А 192	Р 208	а 224	р 240
1	0001	Ғ́ 129	‘ 145	Ў 161	± 177	Б 193	С 209	б 225	с 241
2	0010	, 130	, 146	ў 162	І 178	В 194	Т 210	в 226	т 242
3	0011	Ғ́ 131	“ 147	Ј 163	і 179	Г 195	У 211	г 227	у 243
4	0100	” 132	” 148	Ѡ 164	Г 180	Д 196	Ф 212	д 228	ф 244
5	0101	… 133	• 149	Г 165	μ 181	Е 197	Х 213	е 229	х 245
6	0110	† 134	— 150	І 166	¶ 182	Ж 198	Ц 214	ж 230	ц 246
7	0111	‡ 135	— 151	§ 167	· 183	З 199	Ч 215	з 231	ч 247
8	1000	€ 136	™ 152	Ë 168	ë 184	И 200	Ш 216	и 232	ш 248
9	1001	‰ 137	™ 153	© 169	№ 185	Й 201	Щ 217	й 233	щ 249
A	1010	Љ 138	Љ 154	Є 170	є 186	К 202	Ъ 218	к 234	ъ 250
B	1011	‹ 139	› 155	« 171	» 187	Л 203	Ы 219	л 235	ы 251
C	1100	Њ 140	Њ 156	¬ 172	ј 188	М 204	Ь 220	м 236	ь 252
D	1101	Ќ 141	Ќ 157	- 173	ѕ 189	Н 205	Э 221	н 237	э 253
E	1110	Ғ 142	Һ 158	® 174	ѕ 190	О 206	Ю 222	о 238	ю 254
F	1111	Ғ 143	Ғ 159	İ 175	ï 191	П 207	Я 223	п 239	я 255

20. Page 29 - 737 (Greek)

	HEX	8	9	A	B	C	D	E	F
HEX	BIN	1000	1001	1010	1011	1100	1101	1110	1111
0	0000	Α 128	Ρ 144	ι 160	 176	Λ 192	⊥ 208	ω 224	Ω 240
1	0001	Β 129	Σ 145	κ 161	 177	⊥ 193	⊥ 209	ά 225	± 241
2	0010	Γ 130	Τ 146	λ 162	 178	⊥ 194	⊥ 210	έ 226	≥ 242
3	0011	Δ 131	Υ 147	μ 163	 179	⊥ 195	⊥ 211	ή 227	≤ 243
4	0100	Ε 132	Φ 148	ν 164	⊥ 180	— 196	⊥ 212	ϊ 228	Ï 244
5	0101	Ζ 133	Χ 149	ξ 165	⊥ 181	⊥ 197	⊥ 213	ί 229	ÿ 245
6	0110	Η 134	Ψ 150	ο 166	⊥ 182	⊥ 198	⊥ 214	ό 230	÷ 246
7	0111	Θ 135	Ω 151	π 167	⊥ 183	⊥ 199	⊥ 215	ύ 231	≈ 247
8	1000	Ι 136	α 152	ρ 168	⊥ 184	⊥ 200	⊥ 216	ύ 232	° 248
9	1001	Κ 137	β 153	σ 169	⊥ 185	⊥ 201	⊥ 217	ώ 233	· 249
A	1010	Λ 138	γ 154	ς 170	 186	⊥ 202	⊥ 218	Α 234	· 250
B	1011	Μ 139	δ 155	τ 171	⊥ 187	⊥ 203	■ 219	Ε 235	√ 251
C	1100	Ν 140	ε 156	υ 172	⊥ 188	⊥ 204	■ 220	Η 236	n 252
D	1101	Ξ 141	ζ 157	φ 173	⊥ 189	⊥ 205	■ 221	Ι 237	² 253
E	1110	Ο 142	η 158	χ 174	⊥ 190	⊥ 206	■ 222	Ό 238	■ 254
F	1111	Π 143	θ 159	ψ 175	⊥ 191	⊥ 207	■ 223	Υ 239	SP 255

21. Page 30 - 775 (Baltic)

	HEX	8	9	A	B	C	D	E	F
HEX	BIN	1000	1001	1010	1011	1100	1101	1110	1111
0	0000	Ć 128	É 144	Ā 160	▒	Ł 192	ą 208	Ó 224	- 240
1	0001	ü 129	æ 145	Ī 161	▒	ł 193	č 209	ß 225	± 241
2	0010	é 130	Æ 146	ó 162	▒	ṽ 194	ę 210	Ō 226	“ 242
3	0011	ā 131	ō 147	ž 163	 179	ł 195	è 211	Ń 227	¾ 243
4	0100	ä 132	ö 148	ž 164	┘ 180	— 196	ì 212	õ 228	¶ 244
5	0101	ğ 133	Ĝ 149	ž 165	À 181	† 197	š 213	Õ 229	§ 245
6	0110	å 134	ç 150	” 166	Č 182	Ų 198	ų 214	μ 230	÷ 246
7	0111	ć 135	ś 151	ı 167	Ę 183	Ū 199	ū 215	ń 231	” 247
8	1000	ł 136	ś 152	© 168	Ē 184	Ł 200	ž 216	Ɔ 232	° 248
9	1001	ē 137	Ö 153	® 169	≡ 185	Ŧ 201	ǰ 217	ķ 233	· 249
A	1010	Ŕ 138	Ü 154	¬ 170	∥ 186	≡ 202	Ŧ 218	Ł 234	· 250
B	1011	ŕ 139	ø 155	½ 171	┘ 187	≡ 203	■ 219	ǰ 235	¹ 251
C	1100	ī 140	£ 156	¼ 172	┘ 188	ł 204	■ 220	ŋ 236	³ 252
D	1101	ž 141	Ø 157	ł 173	ł 189	≡ 205	■ 221	Ē 237	² 253
E	1110	Ä 142	× 158	« 174	Š 190	≡ 206	■ 222	Ń 238	■ 254
F	1111	Å 143	α 159	» 175	┘ 191	Ž 207	■ 223	' 239	SP 255

22. Page 31 - Thai character code 14

	HEX	8	9	A	B	C	D	E	F
HEX	BIN	1000	1001	1010	1011	1100	1101	1110	1111
0	0000	┌ 128	┌ 144	┌ 160	┌ 176	┌ 192	┌ 208	┌ 224	┌ 240
1	0001	┐ 129	┐ 145	┐ 161	┐ 177	┐ 193	┐ 209	┐ 225	┐ 241
2	0010	└ 130	└ 146	└ 162	└ 178	└ 194	└ 210	└ 226	└ 242
3	0011	┘ 131	┘ 147	┘ 163	┘ 179	┘ 195	┘ 211	┘ 227	┘ 243
4	0100	┌ 132	┌ 148	┌ 164	┌ 180	┌ 196	┌ 212	┌ 228	┌ 244
5	0101	┐ 133	┐ 149	┐ 165	┐ 181	┐ 197	┐ 213	┐ 229	┐ 245
6	0110	└ 134	└ 150	└ 166	└ 182	└ 198	└ 214	└ 230	└ 246
7	0111	┘ 135	┘ 151	┘ 167	┘ 183	┘ 199	┘ 215	┘ 231	┘ 247
8	1000	┌ 136	┌ 152	┌ 168	┌ 184	┌ 200	┌ 216	┌ 232	┌ 248
9	1001	┐ 137	┐ 153	┐ 169	┐ 185	┐ 201	┐ 217	┐ 233	┐ 249
A	1010	└ 138	└ 154	└ 170	└ 186	└ 202	└ 218	└ 234	└ 250
B	1011	┘ 139	┘ 155	┘ 171	┘ 187	┘ 203	┘ 219	┘ 235	┘ 251
C	1100	┌ 140	┌ 156	┌ 172	┌ 188	┌ 204	┌ 220	┌ 236	┌ 252
D	1101	┐ 141	┐ 157	┐ 173	┐ 189	┐ 205	┐ 221	┐ 237	┐ 253
E	1110	└ 142	└ 158	└ 174	└ 190	└ 206	└ 222	└ 238	└ 254
F	1111	┘ 143	┘ 159	┘ 175	┘ 191	┘ 207	┘ 223	┘ 239	┘ 255

23. Page 32 - Hebrew Old code

	HEX	0	1	2	3	4	5	6	7
HEX	BIN	0000	0001	0010	0011	0100	0101	0110	0111
0	0000	00	16	32	48	64	80	96	112
					0	@	P	א	ן
1	0001	01	17	33	49	65	81	97	113
				!	1	A	Q	ב	ס
2	0010	02	18	34	50	66	82	98	114
				"	2	B	R	ג	ע
3	0011	03	19	35	51	67	83	99	115
				#	3	C	S	ד	ף
4	0100	04	20	36	52	68	84	100	116
				\$	4	D	T	ה	פ
5	0101	05	21	37	53	69	85	101	117
				%	5	E	U	ו	ץ
6	0110	06	22	38	54	70	86	102	118
				&	6	F	V	ז	צ
7	0111	07	23	39	55	71	87	103	119
				'	7	G	W	ח	ק
8	1000	08	24	40	56	72	88	104	120
				(8	H	X	ט	ך
9	1001	09	25	41	57	73	89	105	121
)	9	I	Y	י	ש
A	1010	10	26	42	58	74	90	106	122
				*	:	J	Z	ך	ת
B	1011	11	27	43	59	75	91	107	123
				+	;	K	[כ	{
C	1100	12	28	44	60	76	92	108	124
				,	<	L	\	ל	
D	1101	13	29	45	61	77	93	109	125
				-	=	M]	ם	}
E	1110	14	30	46	62	78	94	110	126
				.	>	N	^	נ	~
F	1111	15	31	47	63	79	95	111	127
				/	?	O	_	ן	

24. Page 33 - 1255 (Hebrew New code)

	HEX	8	9	A	B	C	D	E	F
HEX	BIN	1000	1001	1010	1011	1100	1101	1110	1111
0	0000	€ 128		NBSP 160	° 176		 208	א 224	ן 240
1	0001		‘ 145	ı 161	± 177	“ 193	’ 209	ב 225	ס 241
2	0010	, 130	, 146	¢ 162	² 178	“ 194	’ 210	ג 226	ע 242
3	0011	f 131	“ 147	£ 163	³ 179	“ 195	: 211	ד 227	ף 243
4	0100	” 132	” 148	₪ 164	’ 180	’ 196	ן 212	ה 228	פ 244
5	0101	... 133	• 149	¥ 165	μ 181	“ 197	ן 213	ו 229	ץ 245
6	0110	† 134	— 150	 166	¶ 182	“ 198	” 214	ז 230	צ 246
7	0111	‡ 135	— 151	§ 167	· 183	· 199	’ 215	ח 231	ק 247
8	1000	^ 136	~ 152	“ 168	’ 184	’ 200	” 216	ט 232	ך 248
9	1001	‰ 137	™ 153	© 169	¹ 185	’ 201	’ 217	י 233	ש 249
A	1010			× 170	÷ 186			ך 234	ת 250
B	1011	< 139	> 155	« 171	» 187	“ 203	’ 219	כ 235	
C	1100			¬ 172	¼ 188	’ 204	’ 220	ל 236	
D	1101			- 173	½ 189	’ 205	’ 221	ם 237	LTR 253
E	1110			® 174	¾ 190	· 206	’ 222	נ 238	RTL 254
F	1111			— 175	¿ 191	· 207	’ 223	ן 239	

25. Page 34 - Thai character code 11

	HEX	8	9	A	B	C	D	E	F
HEX	BIN	1000	1001	1010	1011	1100	1101	1110	1111
0	0000	๕- 128	๕+ 144	๖ 160	๗ 176	๘ 192	๙ 208	๐ 224	๑ 240
1	0001	๕๕ 129	๕๖ 145	๕๗ 161	๕๘ 177	๕๙ 193	๖๐ 209	๖๑ 225	๖๒ 241
2	0010	๕๖ 130	๕๗ 146	๕๘ 162	๕๙ 178	๖๐ 194	๖๑ 210	๖๒ 226	๖๓ 242
3	0011	๕๗ 131	๕๘ 147	๕๙ 163	๖๐ 179	๖๑ 195	๖๒ 211	๖๓ 227	๖๔ 243
4	0100	๕๘ 132	๕๙ 148	๖๐ 164	๖๑ 180	๖๒ 196	๖๓ 212	๖๔ 228	๖๕ 244
5	0101	๕๙ 133	๖๐ 149	๖๑ 165	๖๒ 181	๖๓ 197	๖๔ 213	๖๕ 229	๖๖ 245
6	0110	๖๐ 134	๖๑ 150	๖๒ 166	๖๓ 182	๖๔ 198	๖๕ 214	๖๖ 230	๖๗ 246
7	0111	๖๑ 135	๖๒ 151	๖๓ 167	๖๔ 183	๖๕ 199	๖๖ 215	๖๗ 231	๖๘ 247
8	1000	๖๒ 136	๖๓ 152	๖๔ 168	๖๕ 184	๖๖ 200	๖๗ 216	๖๘ 232	๖๙ 248
9	1001	๖๓ 137	๖๔ 153	๖๕ 169	๖๖ 185	๖๗ 201	๖๘ 217	๖๙ 233	๗๐ 249
A	1010	๖๔ 138	๖๕ 154	๖๖ 170	๖๗ 186	๖๘ 202	๖๙ 218	๗๐ 234	๗๑ 250
B	1011	๖๕ 139	๖๖ 155	๖๗ 171	๖๘ 187	๖๙ 203	๗๐ 219	๗๑ 235	๗๒ 251
C	1100	๖๖ 140	๖๗ 156	๖๘ 172	๖๙ 188	๗๐ 204	๗๑ 220	๗๒ 236	๗๓ 252
D	1101	๖๗ 141	๖๘ 157	๖๙ 173	๗๐ 189	๗๑ 205	๗๒ 221	๗๓ 237	๗๔ 253
E	1110	๖๘ 142	๖๙ 158	๗๐ 174	๗๑ 190	๗๒ 206	๗๓ 222	๗๔ 238	๗๕ 254
F	1111	๖๙ 143	๗๐ 159	๗๑ 175	๗๒ 191	๗๓ 207	๗๔ 223	๗๕ 239	๗๖ 255

26. Page 35 - Thai character code 18

	HEX	8	9	A	B	C	D	E	F
HEX	BIN	1000	1001	1010	1011	1100	1101	1110	1111
0	0000	┌ 128	ˆ 144	 160	๒ 176	๓ 192	๔ 208	๕ 224	๖ 240
1	0001	└ 129	๑ 145	๓ 161	๔๓ 177	๓ 193	๔ 209	๕๕ 225	๖๑ 241
2	0010	┌ 130	๔- 146	๒ 162	๓๓ 178	๒ 194	๓ 210	๔๐ 226	๕๒ 242
3	0011	└ 131	๔๔ 147	๒๒ 163	๓๒ 179	๒ 195	๓๐ 211	๔๐ 227	๕๓ 243
4	0100	┌ 132	๔๕ 148	๒ 164	๓๑ 180	๒ 196	๓๐ 212	๔๐ 228	๕๔ 244
5	0101	└ 133	๔๕ 149	๒ 165	๓๑ 181	๒ 197	๓๐ 213	๔๐ 229	๕๕ 245
6	0110	┌ 134	๒- 150	๓๓ 166	๓๑ 182	๒ 198	๓๐ 214	๔๐ 230	๕๖ 246
7	0111	└ 135	๒๔ 151	๓ 167	๓๒ 183	๒ 199	๓๐ 215	๔๐ 231	๕๗ 247
8	1000	┌ 136	๒๓ 152	๓ 168	๓๒ 184	๒ 200	๓๐ 216	๔๐ 232	๕๘ 248
9	1001	└ 137	๒๓ 153	๓ 169	๓๒ 185	๒ 201	๓๐ 217	๔๐ 233	๕๙ 249
A	1010	┌ 138	๒๓ 154	๓ 170	๓๒ 186	๒ 202	๓๐ 218	๔๐ 234	๕๙ 250
B	1011	█ 139	๒- 155	๓๒ 171	๓๑ 187	๒ 203	๓๐ 219	๔๐ 235	๕๙ 251
C	1100	← 140	๒๔ 156	๓๓ 172	๓๑ 188	๒ 204	๓๐ 220	๔๐ 236	๕๙ 252
D	1101	↑ 141	๒๓ 157	๓๒ 173	๓๑ 189	๒ 205	๓๐ 221	๔๐ 237	๕๙ 253
E	1110	→ 142	๒๓ 158	๓๒ 174	๓๑ 190	๒ 206	๓๐ 222	๔๐ 238	๕๙ 254
F	1111	↓ 143	๒ 159	๓๒ 175	๓๑ 191	๒ 207	๓๐ 223	๔๐ 239	๕๙ 255

27. Page 36 - 855 (Cyrillic)

	HEX	8	9	A	B	C	D	E	F
HEX	BIN	1000	1001	1010	1011	1100	1101	1110	1111
0	0000	ђ 128	љ 144	а 160	▒ 176	Љ 192	Л 208	Я 224	- 240
1	0001	Ђ 129	Љ 145	А 161	▒ 177	Љ 193	Л 209	Р 225	Ы 241
2	0010	ѓ 130	њ 146	б 162	▒ 178	Т 194	М 210	Р 226	Ы 242
3	0011	Ђ 131	Њ 147	Б 163	▒ 179	Т 195	М 211	С 227	З 243
4	0100	ѐ 132	ћ 148	ц 164	† 180	— 196	Н 212	С 228	З 244
5	0101	Ё 133	Ћ 149	Ц 165	х 181	† 197	Н 213	Т 229	Ш 245
6	0110	е 134	ќ 150	д 166	Х 182	К 198	О 214	Т 230	Ш 246
7	0111	Є 135	Ќ 151	Д 167	и 183	К 199	О 215	У 231	Э 247
8	1000	ѕ 136	ђ 152	е 168	И 184	Љ 200	П 216	У 232	Э 248
9	1001	Ѕ 137	Ђ 153	Е 169	 185	Љ 201	П 217	Ж 233	Щ 249
A	1010	і 138	џ 154	ф 170	 186	Љ 202	Г 218	Ж 234	Щ 250
B	1011	І 139	Џ 155	Ф 171	 187	Љ 203	■ 219	В 235	Ч 251
C	1100	ї 140	џ 156	Г 172	 188	Љ 204	■ 220	В 236	Ч 252
D	1101	Ї 141	Ј 157	Г 173	й 189	= 205	П 221	Ь 237	§ 253
E	1110	ј 142	ѣ 158	« 174	Й 190	 206	я 222	Ь 238	■ 254
F	1111	Ј 143	ѣ 159	» 175	Г 191	Ѡ 207	■ 223	№ 239	

28. Page 37 - 857 (Turkish)

	HEX	8	9	A	B	C	D	E	F
HEX	BIN	1000	1001	1010	1011	1100	1101	1110	1111
0	0000	Ç 128	É 144	á 160	◼ 176	L 192	o 208	Ó 224	- 240
1	0001	ü 129	æ 145	í 161	◼ 177	⊥ 193	a 209	ß 225	± 241
2	0010	é 130	Æ 146	ó 162	◼ 178	T 194	Ê 210	Ô 226	
3	0011	â 131	ô 147	ú 163	 179	† 195	Ë 211	Ò 227	¾ 243
4	0100	ä 132	ö 148	ñ 164	† 180	- 196	È 212	õ 228	¶ 244
5	0101	à 133	ò 149	Ñ 165	Á 181	† 197		Õ 229	§ 245
6	0110	å 134	û 150	Ğ 166	Â 182	ã 198	Í 214	μ 230	÷ 246
7	0111	ç 135	ù 151	ğ 167	À 183	Ã 199	Î 215		, 247
8	1000	ê 136	ï 152	ı 168	© 184	ℒ 200	Ï 216	× 232	° 248
9	1001	ë 137	Ö 153	® 169	¶ 185	ƒ 201	Ɔ 217	Ú 233	¨ 249
A	1010	è 138	Ü 154	¬ 170	 186	⊥ 202	ƒ 218	Û 234	· 250
B	1011	ï 139	ø 155	½ 171	¶ 187	⊥ 203	◼ 219	Ü 235	¹ 251
C	1100	î 140	£ 156	¼ 172	¶ 188	⊥ 204	◼ 220	ì 236	³ 252
D	1101	1 141	Ø 157	ı 173	¢ 189	= 205	ı 221	ÿ 237	² 253
E	1110	Ä 142	Ş 158	« 174	¥ 190	¶ 206	Ï 222	- 238	■ 254
F	1111	Å 143	ş 159	» 175	₯ 191	○ 207	◼ 223	' 239	

29. Page 38 - 928 (Greek)

	HEX	8	9	A	B	C	D	E	F
HEX	BIN	1000	1001	1010	1011	1100	1101	1110	1111
0	0000	128	144	160	176	192	208	224	240
1	0001	129	145	161	177	193	209	225	241
2	0010	130	146	162	178	194	210	226	242
3	0011	131	147	163	179	195	211	227	243
4	0100	132	148	164	180	196	212	228	244
5	0101	133	149	165	181	197	213	229	245
6	0110	134	150	166	182	198	214	230	246
7	0111	135	151	167	183	199	215	231	247
8	1000	136	152	168	184	200	216	232	248
9	1001	137	153	169	185	201	217	233	249
A	1010	138	154	170	186	202	218	234	250
B	1011	139	155	171	187	203	219	235	251
C	1100	140	156	172	188	204	220	236	252
D	1101	141	157	173	189	205	221	237	253
E	1110	142	158	174	190	206	222	238	254
F	1111	143	159	175	191	207	223	239	255

30. Page 39 - Thai 16

	HEX	8	9	A	B	C	D	E	F
HEX	BIN	1000	1001	1010	1011	1100	1101	1110	1111
0	0000	┌ 128	ໂ 144	 160	๓ 176	๓ 192	๕ 208	๖ 224	๐ 240
1	0001	┐ 129	ใ 145	ก 161	๓ 177	๓ 193	๕ 209	๖ 225	๑ 241
2	0010	└ 130	๕ 146	ข 162	๓ 178	๓ 194	๕ 210	๖ 226	๒ 242
3	0011	┘ 131	๕ 147	ข 163	๓ 179	๓ 195	๕ 211	๖ 227	๓ 243
4	0100	 132	๕ 148	ค 164	๓ 180	๓ 196	๕ 212	๖ 228	๔ 244
5	0101	— 133	๕ 149	ค 165	๓ 181	๓ 197	๕ 213	๖ 229	๕ 245
6	0110	┌ 134	๕ 150	ฃ 166	๓ 182	๓ 198	๕ 214	๖ 230	๖ 246
7	0111	┐ 135	๕ 151	ง 167	๓ 183	๓ 199	๕ 215	๖ 231	๗ 247
8	1000	└ 136	๕ 152	จ 168	๓ 184	๓ 200	๕ 216	๖ 232	๘ 248
9	1001	┘ 137	๕ 153	ฉ 169	๓ 185	๓ 201	๕ 217	๖ 233	๙ 249
A	1010	┘ 138	๕ 154	ช 170	๓ 186	๓ 202	๕ 218	๖ 234	๐ 250
B	1011	█ 139	๕ 155	ช 171	๓ 187	๓ 203	๕ 219	๖ 235	๑ 251
C	1100	← 140	๕ 156	ฅ 172	๓ 188	๓ 204	๕ 220	๖ 236	๒ 252
D	1101	↑ 141	๕ 157	ญ 173	๓ 189	๓ 205	๕ 221	๖ 237	๓ 253
E	1110	→ 142	๕ 158	ฎ 174	๓ 190	๓ 206	๕ 222	๖ 238	๔ 254
F	1111	↓ 143	๕ 159	ฏ 175	๓ 191	๓ 207	๕ 223	๖ 239	๕ 255

31. Page 40 - 1256 (Arabic)

	HEX	8	9	A	B	C	D	E	F
HEX	BIN	1000	1001	1010	1011	1100	1101	1110	1111
0	0000	€ 128	ك 144		° 160	□ 176	ذ 192	à 208	° 224
1	0001	پ 129	‘ 145	، 161	± 177	ء 193	ر 209	ل 225	” 241
2	0010	، 130	’ 146	¢ 162	² 178	آ 194	ز 210	â 226	° 242
3	0011	f 131	“ 147	£ 163	³ 179	أ 195	س 211	م 227	´ 243
4	0100	” 132	” 148	¤ 164	´ 180	ؤ 196	ش 212	ن 228	ô 244
5	0101	... 133	• 149	¥ 165	µ 181	إ 197	ص 213	ه 229	´ 245
6	0110	† 134	– 150	¡ 166	¶ 182	ئ 198	ض 214	و 230	´ 246
7	0111	‡ 135	— 151	§ 167	· 183	ا 199	× 215	ç 231	÷ 247
8	1000	^ 136	ك 152	¨ 168	د 184	ب 200	ط 216	è 232	´ 248
9	1001	‰ 137	™ 153	© 169	¹ 185	ة 201	ظ 217	é 233	ù 249
A	1010	□ 138	□ 154	□ 170	؛ 186	ت 202	ع 218	ê 234	° 250
B	1011	< 139	> 155	« 171	» 187	ث 203	غ 219	ë 235	û 251
C	1100	œ 140	œ 156	¬ 172	¼ 188	ج 204	- 220	ى 236	ü 252
D	1101	چ 141		- 173	½ 189	ح 205	ف 221	ي 237	
E	1110	ژ 142		® 174	¾ 190	خ 206	ق 222	î 238	
F	1111	□ 143	□ 159	– 175	؟ 191	د 207	ك 223	ï 239	□ 255

32. Page 41 - 1258 (Vietnam)

	HEX	8	9	A	B	C	D	E	F
HEX	BIN	1000	1001	1010	1011	1100	1101	1110	1111
0	0000	€ 128			° 176	À 192	Đ 208	à 224	đ 240
1	0001		‘ 145	ì 161	± 177	Á 193	Ñ 209	á 225	ñ 241
2	0010	’ 130	’ 146	¢ 162	2 178	Â 194	ò 210	â 226	ô 242
3	0011	f 131	“ 147	£ 163	3 179	Ã 195	Ó 211	ã 227	ó 243
4	0100	” 132	” 148	¤ 164	´ 180	Ä 196	Ô 212	ä 228	ô 244
5	0101	… 133	• 149	¥ 165	µ 181	Å 197	Õ 213	å 229	õ 245
6	0110	† 134	- 150	 166	¶ 182	Æ 198	Ö 214	æ 230	ö 246
7	0111	‡ 135	— 151	§ 167	• 183	Ç 199	× 215	ç 231	÷ 247
8	1000	^ 136	~ 152	" 168	· 184	È 200	Ø 216	è 232	ø 248
9	1001	‰ 137	™ 153	© 169	1 185	É 201	Ù 217	é 233	ù 249
A	1010			à 170	ó 186	Ê 202	Ú 218	ê 234	ú 250
B	1011	{ 139) 155	« 171	» 187	Ë 203	Û 219	ë 235	û 251
C	1100	Œ 140	œ 156	¬ 172	¼ 188	ì 204	Ü 220	í 236	ü 252
D	1101			¯ 173	½ 189	Í 205	Ū 221	î 237	Û 253
E	1110			® 174	¾ 190	Î 206	ÿ 222	ï 238	ü 254
F	1111		ÿ 159	¯ 175	¿ 191	Ï 207	ß 223	ı 239	ÿ 255

33. Page 42 - Khmer (Cambodia)

	HEX	8	9	A	B	C	D	E	F
HEX	BIN	1000	1001	1010	1011	1100	1101	1110	1111
0	0000	កី 128	ថ 144	ហា 160	ព្យ 176	រៀ 192	្រ 208	័ 224	្រ 240
1	0001	ខ 129	ទ 145	ឡ 161	ឱ 177	្រ 193	្រ 209	័ 225	្រ 241
2	0010	គី 130	ធ 146	អ 162	ច 178	្រ 194	្រ 210	័ 226	្រ 242
3	0011	យ 131	ជ 147	អ 163	ឱ 179	្រ 195	្រ 211	័ 227	្រ 243
4	0100	ង 132	ប 148	អា 164	KIV AA 180	្រ 196	័ 212	័ 228	្រ 244
5	0101	ច 133	ជ 149	ត 165	KIV AA 181	្រ 197	័ 213	័ 229	្រ 245
6	0110	ឆ 134	ព 150	ឡ 166	្រ 182	្រ 198	័ 214	័ 230	្រ 246
7	0111	ជ 135	ត 151	ឱ 167	្រ 183	្រ 199	័ 215	័ 231	្រ 247
8	1000	ឃ 136	ម 152	ឱ 168	្រ 184	្រ 200	័ 216	័ 232	្រ 248
9	1001	ញ 137	យ 153	ឱ 169	្រ 185	្រ 201	័ 217	័ 233	្រ 249
A	1010	ជ 138	រ 154	ឱ 170	្រ 186	្រ 202	័ 218	័ 234	្រ 250
B	1011	ថ 139	ល 155	ប្រ 171	្រ 187	្រ 203	័ 219	័ 235	្រ 251
C	1100	ឱ 140	រ 156	ប្រ 172	្រ 188	្រ 204	័ 220	័ 236	្រ 252
D	1101	ឆ 141	គ 157	ព្យ 173	្រ 189	្រ 205	័ 221	័ 237	្រ 253
E	1110	ណា 142	ថ 158	ព្យ 174	្រ 190	្រ 206	័ 222	័ 238	្រ 254
F	1111	ត 143	ស 159	ង 175	្រ 191	្រ 207	័ 223	័ 239	្រ 255

34. Page 47 - 1250 (Czech)

	HEX	8	9	A	B	C	D	E	F
HEX	BIN	1000	1001	1010	1011	1100	1101	1110	1111
0	0000	€ 128		NBSP 160	° 176	Ř 192	Đ 208	ř 224	ď 240
1	0001		‘ 145	˘ 161	± 177	Á 193	Ň 209	á 225	ň 241
2	0010	, 130	, 146	˘ 162	˘ 178	Ā 194	Ň 210	â 226	ň 242
3	0011	f 131	“ 147	£ 163	† 179	Ā 195	Ó 211	ă 227	ó 243
4	0100	” 132	” 148	α 164	˘ 180	Ă 196	Ô 212	ä 228	ô 244
5	0101	… 133	• 149	Α 165	μ 181	Ĺ 197	Õ 213	í 229	õ 245
6	0110	† 134	— 150	ı 166	¶ 182	Ć 198	Ö 214	ć 230	ö 246
7	0111	‡ 135	— 151	§ 167	˘ 183	Ç 199	× 215	ç 231	÷ 247
8	1000	^ 136	~ 152	¨ 168	˘ 184	Č 200	Ř 216	č 232	ř 248
9	1001	‰ 137	™ 153	© 169	ą 185	É 201	Û 217	é 233	ű 249
A	1010	Š 138	š 154	Ş 170	ş 186	Ę 202	Ú 218	ę 234	ú 250
B	1011	< 139	> 155	« 171	» 187	Ě 203	Ů 219	ě 235	ů 251
C	1100	Š 140	ś 156	¬ 172	Ĺ 188	Ě 204	Ü 220	ě 236	ü 252
D	1101	Ť 141	ť 157	- 173	" 189	Í 205	Ý 221	í 237	ý 253
E	1110	Ž 142	ž 158	® 174	ı 190	Î 206	Ț 222	î 238	ț 254
F	1111	Ž 143	ż 159	Ż 175	ż 191	Đ 207	ß 223	đ 239	· 255

35. Page 48 - TCVN-3 : Vietnamese1

	HEX	8	9	A	B	C	D	E	F
HEX	BIN	1000	1001	1010	1011	1100	1101	1110	1111
0	0000	128	144	160	176	192	é 208	224	240
1	0001	129	145	161	177	193	ẹ 209	ỏ 225	ủ 241
2	0010	130	146	162	178	194	ề 210	ỡ 226	ũ 242
3	0011	131	147	163	179	195	ễ 211	ó 227	ú 243
4	0100	132	148	164	180	196	ể 212	ọ 228	ụ 244
5	0101	133	149	165	à 181	197	ễ 213	ồ 229	ừ 245
6	0110	134	150	166	ả 182	ă 198	ệ 214	ở 230	ử 246
7	0111	135	151	167	ã 183	ã 199	ì 215	ỗ 231	ữ 247
8	1000	136	152	ă 168	á 184	ã 200	ỉ 216	ổ 232	ừ 248
9	1001	137	153	â 169	ạ 185	ã 201	217	ộ 233	ự 249
A	1010	138	154	ê 170	186	ã 202	218	ờ 234	ỳ 250
B	1011	139	155	ô 171	ã 187	ạ 203	219	ở 235	ỷ 251
C	1100	140	156	ơ 172	ã 188	è 204	ĩ 220	ỡ 236	ỹ 252
D	1101	141	157	ư 173	ã 189	205	í 221	ờ 237	ý 253
E	1110	142	158	đ 174	ã 190	ẻ 206	ị 222	ợ 238	ỵ 254
F	1111	143	159	175	191	ễ 207	ò 223	ù 239	255

36. Page 48 - TCVN-3 : Vietnamese2

	HEX	8	9	A	B	C	D	E	F
HEX	BIN	1000	1001	1010	1011	1100	1101	1110	1111
0	0000	128	144	160	176	192	É 208	224	240
1	0001	129	145	Ă 161	177	193	Ê 209	Ó 225	Ù 241
2	0010	130	146	Â 162	178	194	Ë 210	Ö 226	Û 242
3	0011	131	147	163	179	195	Ë 211	Ó 227	Ú 243
4	0100	132	148	164	180	196	Ë 212	Ô 228	Û 244
5	0101	133	149	165	À 181	197	Ë 213	Ö 229	Û 245
6	0110	134	150	166	Â 182	Ă 198	Ê 214	Ö 230	Û 246
7	0111	135	151	Đ 167	Ă 183	Â 199	Ë 215	Ö 231	Û 247
8	1000	136	152	168	À 184	Ă 200	Ë 216	Ö 232	Ú 248
9	1001	137	153	169	À 185	Ă 201	217	Ö 233	Û 249
A	1010	138	154	Ê 170	186	Ă 202	218	Ö 234	Û 250
B	1011	139	155	Ô 171	Ă 187	Â 203	219	Ö 235	Û 251
C	1100	140	156	Û 172	Ă 188	È 204	Ë 220	Ö 236	Û 252
D	1101	141	157	Û 173	Ă 189	205	Ë 221	Ö 237	Û 253
E	1110	142	158	174	Ă 190	È 206	Ë 222	Ö 238	Û 254
F	1111	143	159	175	191	È 207	Ò 223	Ù 239	255

37. International character code table

No	Country	ASCII code (Hexadecimal number)													
		23	24	25	26	40	5B	5C	5D	5E	60	7B	7C	7D	7E
0	U.S.A	#	\$	%	&	@	[\]	^	`	{		}	~
1	France	#	\$	%	&	à	°	ç	§	^	`	é	ù	è	¨
2	Germany	#	\$	%	&	§	Ä	Ö	Ü	^	`	ä	ö	ü	β
3	U.K.	£	\$	%	&	@	[\]	^	`	{		}	~
4	Denmark I	#	\$	%	&	@	Æ	Ø	Å	^	`	æ	ø	å	~
5	Sweden	#	¤	%	&	É	Ä	Ö	Å	Ü	é	ä	ö	å	ü
6	Italy	#	\$	%	&	@	°	\	é	^	ù	à	ò	è	ì
7	Spain I	Pt	\$	%	&	@	ı	Ñ	ı	^	`	¨	ñ	}	~
8	Japan	#	\$	%	&	@	[¥]	^	`	{		}	~
9	Norway	#	¤	%	&	É	Æ	Ø	Å	Ü	é	æ	ø	å	ü
10	Denmark II	#	\$	%	&	É	Æ	Ø	Å	Ü	é	æ	ø	å	ü
11	Spain II	#	\$	%	&	á	ı	Ñ	ı	é	`	í	ñ	ó	ú
12	Latin America	#	\$	%	&	á	ı	Ñ	ı	é	ü	í	ñ	ó	ú
13	Korea	#	\$	%	&	@	[\]	^		{		}	~