

BIXOLON®

Code Pages

SRP-F310/F312/F313II

Thermal Printer

Rev. 1.00

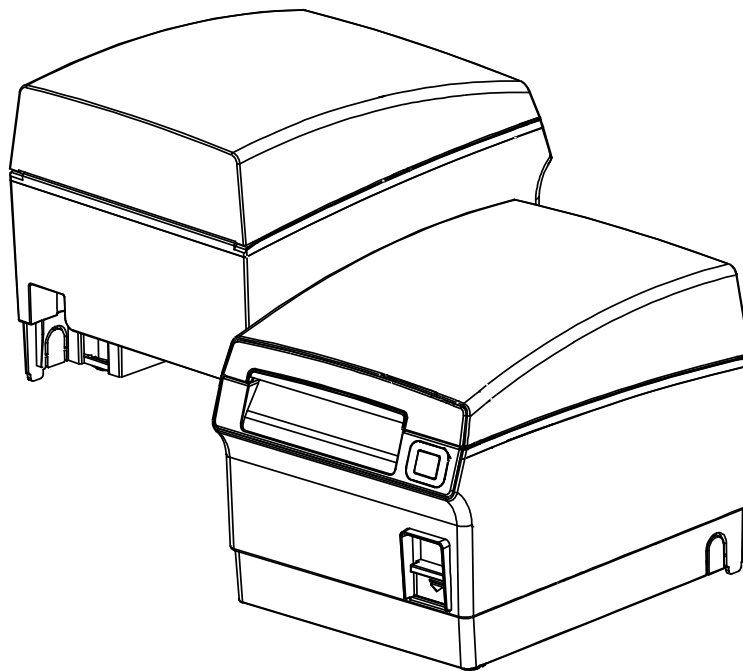

<http://www.bixolon.com>

■ Table of Contents

1. Notice.....3
2. Page 0 - 437 (USA, Standard Europe).....3
3. Page 1 - Katakana4
4. Page 2 - 850 (Multilingual)5
5. Page 3 - 860 (Portuguese).....6
6. Page 4 - 863 (Canadian-French)7
7. Page 5 - 865 (Nordic).....8
8. Page 16 - 1252 (Latin I)9
9. Page 17 - 866 (Cyrillic #2)10
10. Page 18 - 852 (Latin 2)11
11. Page 19 - 858 (Euro)12
12. Page 21 - 862 (Hebrew DOS code)13
13. Page 22 - 864 (Arabic).....14
14. Page 23 - Thai character code 42.....15
15. Page 24 - 1253 (Greek)16
16. Page 25 - 1254 (Turkish)17
17. Page 26 - 1257 (Baltic)18
18. Page 27 - Farsi19
19. Page 28 - 1251 (Cyrillic)20
20. Page 29 - 737 (Greek)21
21. Page 30 - 775 (Baltic)22
22. Page 31 - Thai character code 14.....23
23. Page 32 - Hebrew Old code.....24
24. Page 33 - 1255 (Hebrew New code).....25
25. Page 34 - Thai character code 1126
26. Page 35 - Thai character code 18.....27
27. Page 36 - 855 (Cyrillic)28
28. Page 37 - 857 (Turkish)29
29. Page 38 - 928 (Greek)30
30. Page 39 - Thai 1631
31. Page 40 - 1256 (Arabic).....32
32. Page 41 - 1258 (Vietnam).....33
33. Page 42 - Khmer (Cambodia)34
34. Page 47 - 1250 (Czech).....35
35. International character code table.....36

1. Notice

The following pages show the character code tables.

To find the character corresponding to a hexadecimal number, count across the top of the table for the left digit and count down the left column of the table for the right digit.

For example, 4A = J. (Page 0)

2. Page 0 - 437 (USA, Standard Europe)

HEX	BIN	0	1	2	3	4	5	6	7	8	9	A	B	C	D	E	F
0	0000	NUL	DLE	SP	0	@	P	`	p	Ç	É	á	☐	⌞	⌞	α	≡
		00	16	32	48	64	80	96	112	128	144	160	176	192	208	224	240
1	0001		!	!	1	A	Q	a	q	ü	æ	í	☐	⌞	⌞	β	±
		01	17	33	49	65	81	97	113	129	145	161	177	193	209	225	241
2	0010		"	"	2	B	R	b	r	é	Æ	ó	☐	⌞	⌞	Γ	≥
		02	18	34	50	66	82	98	114	130	146	162	178	194	210	226	242
3	0011		#	#	3	C	S	c	s	â	ô	ú	☐	⌞	⌞	π	≤
		03	19	35	51	67	83	99	115	131	147	163	179	195	211	227	243
4	0100	EOT		\$	4	D	T	d	t	ä	ö	ñ	☐	⌞	⌞	Σ	ƒ
		04	20	36	52	68	84	100	116	132	148	164	180	196	212	228	244
5	0101	ENQ		%	5	E	U	e	u	à	ò	Ñ	☐	⌞	⌞	σ	ƒ
		05	21	37	53	69	85	101	117	133	149	165	181	197	213	229	245
6	0110		&	&	6	F	V	f	v	â	û	ª	☐	⌞	⌞	μ	÷
		06	22	38	54	70	86	102	118	134	150	166	182	198	214	230	246
7	0111		'	'	7	G	W	g	w	ç	ù	º	☐	⌞	⌞	τ	≈
		07	23	39	55	71	87	103	119	135	151	167	183	199	215	231	247
8	1000	BS	CAN	(8	H	X	h	x	ê	ÿ	ı	☐	⌞	⌞	ϕ	°
		08	24	40	56	72	88	104	120	136	152	168	184	200	216	232	248
9	1001	HT)	9	I	Y	i	y	ë	Ö	ƒ	☐	⌞	⌞	θ	•
		09	25	41	57	73	89	105	121	137	153	169	185	201	217	233	249
A	1010	LF		*	:	J	Z	j	z	è	Ü	ƒ	☐	⌞	⌞	Ω	•
		10	26	42	58	74	90	106	122	138	154	170	186	202	218	234	250
B	1011		ESC	+	;	K	[k	{	ï	ç	1/2	☐	⌞	⌞	δ	√
		11	27	43	59	75	91	107	123	139	155	171	187	203	219	235	251
C	1100	FF	FS	,	<	L	\	l		î	£	1/4	☐	⌞	⌞	∞	∞
		12	28	44	60	76	92	108	124	140	156	172	188	204	220	236	252
D	1101	CR	GS	-	=	M]	m	}	ì	¥	ı	☐	⌞	⌞	φ	²
		13	29	45	61	77	93	109	125	141	157	173	189	205	221	237	253
E	1110		.	>	>	N	^	n	~	Ä	Pt	«	☐	⌞	⌞	ε	•
		14	30	46	62	78	94	110	126	142	158	174	190	206	222	238	254
F	1111		/	?	?	O	_	o	SP	Å	f	»	☐	⌞	⌞	∩	SP
		15	31	47	63	79	95	111	127	143	159	175	191	207	223	239	255

3. Page 1 - Katakana

	HEX	8	9	A	B	C	D	E	F
HEX	BIN	1000	1001	1010	1011	1100	1101	1110	1111
0	0000	█ 128	┌ 144	SP 160	一 176	夕 192	ミ 208	二 224	× 240
1	0001	█ 129	└ 145	。 161	ア 177	チ 193	ム 209	卍 225	円 241
2	0010	█ 130	┌ 146	「 162	イ 178	ツ 194	メ 210	卍 226	年 242
3	0011	█ 131	└ 147	」 163	ウ 179	テ 195	モ 211	卍 227	月 243
4	0100	█ 132	─ 148	、 164	エ 180	ト 196	ヤ 212	▲ 228	日 244
5	0101	█ 133	─ 149	・ 165	オ 181	ナ 197	ユ 213	▲ 229	時 245
6	0110	█ 134	 150	ヲ 166	カ 182	ニ 198	ヨ 214	▼ 230	分 246
7	0111	█ 135	 151	ア 167	キ 183	ヌ 199	ラ 215	▼ 231	秒 247
8	1000	 136	┌ 152	イ 168	ク 184	ネ 200	リ 216	♠ 232	〒 248
9	1001	 137	└ 153	ウ 169	ケ 185	ノ 201	ル 217	♥ 233	市 249
A	1010	█ 138	┌ 154	エ 170	コ 186	ハ 202	レ 218	◆ 234	区 250
B	1011	█ 139	└ 155	オ 171	サ 187	ヒ 203	ロ 219	♣ 235	町 251
C	1100	█ 140	┌ 156	ヤ 172	シ 188	フ 204	ワ 220	● 236	村 252
D	1101	█ 141	└ 157	ユ 173	ス 189	ヘ 205	ン 221	○ 237	人 253
E	1110	█ 142	┌ 158	ヨ 174	セ 190	ホ 206	〃 222	／ 238	■ 254
F	1111	+143	└ 159	ツ 175	ソ 191	マ 207	。 223	＼ 239	SP 255

4. Page 2 - 850 (Multilingual)

	HEX	8	9	A	B	C	D	E	F
HEX	BIN	1000	1001	1010	1011	1100	1101	1110	1111
0	0000	Ç 128	É 144	á 160	☐ 176	Ł 192	š 208	Ó 224	— 240
1	0001	ü 129	æ 145	í 161	☐ 177	⊥ 193	Đ 209	β 225	± 241
2	0010	é 130	Æ 146	ó 162	☐ 178	⌣ 194	Ê 210	Ô 226	= 242
3	0011	â 131	ô 147	ú 163	 179	⌢ 195	Ë 211	Ò 227	3/4 243
4	0100	ä 132	ö 148	ñ 164	⊢ 180	— 196	È 212	õ 228	¶ 244
5	0101	à 133	ò 149	Ñ 165	Á 181	+ 197	i 213	Ö 229	§ 245
6	0110	á 134	û 150	ª 166	Â 182	ã 198	í 214	μ 230	÷ 246
7	0111	ç 135	ù 151	º 167	À 183	Ã 199	î 215	þ 231	· 247
8	1000	ê 136	ÿ 152	¿ 168	© 184	Ł 200	ï 216	ƒ 232	° 248
9	1001	ë 137	Ö 153	® 169	≡ 185	ƒ 201	⌋ 217	Ú 233	¨ 249
A	1010	è 138	Ü 154	¬ 170	 186	⌌ 202	⌈ 218	Û 234	• 250
B	1011	ï 139	ø 155	1/2 171	⌋ 187	⌌ 203	■ 219	Ü 235	1 251
C	1100	î 140	£ 156	1/4 172	⌋ 188	⌌ 204	■ 220	Ý 236	³ 252
D	1101	ì 141	Ø 157	ı 173	¢ 189	= 205	ı 221	Ý 237	² 253
E	1110	Ä 142	X 158	« 174	¥ 190	† 206	ı 222	— 238	▪ 254
F	1111	Å 143	f 159	» 175	⌋ 191	⊗ 207	■ 223	´ 239	SP 255

5. Page 3 - 860 (Portuguese)

	HEX	8	9	A	B	C	D	E	F
HEX	BIN	1000	1001	1010	1011	1100	1101	1110	1111
0	0000	Ç 128	É 144	á 160	☐ 176	⌒ 192	⌒ 208	α 224	≡ 240
1	0001	ü 129	À 145	í 161	☐ 177	⌒ 193	⌒ 209	β 225	± 241
2	0010	é 130	È 146	ó 162	☐ 178	⌒ 194	⌒ 210	Γ 226	≥ 242
3	0011	â 131	ô 147	ú 163	 179	⌒ 195	⌒ 211	π 227	≤ 243
4	0100	ã 132	õ 148	ñ 164	† 180	— 196	⌒ 212	Σ 228	f 244
5	0101	à 133	ò 149	Ñ 165	‡ 181	+ 197	⌒ 213	σ 229	J 245
6	0110	Á 134	Ú 150	ª 166	‡ 182	⌒ 198	⌒ 214	μ 230	÷ 246
7	0111	ç 135	ù 151	º 167	‡ 183	⌒ 199	‡ 215	τ 231	≈ 247
8	1000	ê 136	ì 152	¿ 168	‡ 184	⌒ 200	‡ 216	Φ 232	° 248
9	1001	Ê 137	Õ 153	Ò 169	‡ 185	⌒ 201	⌒ 217	θ 233	• 249
A	1010	è 138	Ü 154	¬ 170	 186	⌒ 202	⌒ 218	Ω 234	• 250
B	1011	í 139	ç 155	1/2 171	‡ 187	⌒ 203	■ 219	δ 235	√ 251
C	1100	Ô 140	£ 156	1/4 172	⌒ 188	⌒ 204	■ 220	∞ 236	n 252
D	1101	ì 141	Ù 157	i 173	⌒ 189	= 205	■ 221	φ 237	² 253
E	1110	Ã 142	Pt 158	« 174	⌒ 190	‡ 206	■ 222	ε 238	▪ 254
F	1111	Â 143	Ó 159	» 175	‡ 191	⌒ 207	■ 223	∩ 239	SP 255

6. Page 4 - 863 (Canadian-French)

	HEX	8	9	A	B	C	D	E	F
HEX	BIN	1000	1001	1010	1011	1100	1101	1110	1111
0	0000	Ç 128	É 144	Ï 160	Ë 176	Ł 192	⌌ 208	α 224	≡ 240
1	0001	ü 129	È 145	´ 161	Ï 177	⌍ 193	⌎ 209	β 225	± 241
2	0010	é 130	Ê 146	ó 162	Ï 178	⌏ 194	⌐ 210	Γ 226	≥ 242
3	0011	â 131	ô 147	ú 163	Ï 179	⌑ 195	⌒ 211	π 227	≤ 243
4	0100	Â 132	Ë 148	ˆ 164	Ï 180	— 196	⌔ 212	Σ 228	ƒ 244
5	0101	à 133	Ï 149	ˆ 165	Ï 181	+ 197	ƒ 213	σ 229	Ƶ 245
6	0110	¶ 134	û 150	³ 166	Ï 182	ƒ 198	⌖ 214	μ 230	÷ 246
7	0111	ç 135	ù 151	— 167	Ï 183	⌗ 199	⌘ 215	τ 231	≈ 247
8	1000	ê 136	œ 152	î 168	Ï 184	⌘ 200	⌙ 216	Φ 232	° 248
9	1001	ë 137	Ô 153	ˆ 169	Ï 185	⌚ 201	⌛ 217	θ 233	• 249
A	1010	è 138	Û 154	ˆ 170	Ï 186	⌛ 202	⌜ 218	Ω 234	• 250
B	1011	ï 139	¢ 155	1/2 171	Ï 187	⌝ 203	■ 219	δ 235	√ 251
C	1100	î 140	£ 156	1/4 172	Ï 188	⌞ 204	■ 220	∞ 236	n 252
D	1101	— 141	Ù 157	3/4 173	Ï 189	— 205	■ 221	φ 237	² 253
E	1110	À 142	Û 158	« 174	Ï 190	⌟ 206	■ 222	ε 238	▪ 254
F	1111	§ 143	f 159	» 175	Ï 191	⌠ 207	■ 223	∩ 239	SP 255



7. Page 5 - 865 (Nordic)

	HEX	8	9	A	B	C	D	E	F
HEX	BIN	1000	1001	1010	1011	1100	1101	1110	1111
0	0000	Ç 128	É 144	á 160	☐ 176	Ł 192	⌌ 208	α 224	≡ 240
1	0001	Û 129	æ 145	í 161	☐ 177	⊥ 193	⌌ 209	β 225	± 241
2	0010	é 130	Æ 146	ó 162	☐ 178	⌌ 194	⌌ 210	Γ 226	≥ 242
3	0011	â 131	ô 147	ú 163	 179	⌌ 195	⌌ 211	π 227	≤ 243
4	0100	ä 132	ö 148	ñ 164	⌌ 180	— 196	⌌ 212	Σ 228	f 244
5	0101	à 133	ò 149	Ñ 165	⌌ 181	+ 197	F 213	σ 229	J 245
6	0110	å 134	û 150	ä 166	⌌ 182	⌌ 198	⌌ 214	μ 230	÷ 246
7	0111	ç 135	ù 151	ø 167	⌌ 183	⌌ 199	⌌ 215	τ 231	≈ 247
8	1000	ê 136	ÿ 152	¿ 168	⌌ 184	⌌ 200	⌌ 216	Φ 232	° 248
9	1001	ë 137	Ö 153	⌌ 169	⌌ 185	⌌ 201	⌌ 217	θ 233	• 249
A	1010	è 138	Û 154	⌌ 170	⌌ 186	⌌ 202	⌌ 218	Ω 234	• 250
B	1011	ï 139	ø 155	1/2 171	⌌ 187	⌌ 203	■ 219	δ 235	√ 251
C	1100	î 140	£ 156	1/4 172	⌌ 188	⌌ 204	■ 220	∞ 236	n 252
D	1101	ì 141	Ø 157	i 173	⌌ 189	= 205	■ 221	φ 237	² 253
E	1110	Ä 142	Pt 158	« 174	⌌ 190	⌌ 206	■ 222	ε 238	▪ 254
F	1111	Å 143	f 159	⌌ 175	⌌ 191	⌌ 207	■ 223	∩ 239	SP 255

8. Page 16 - 1252 (Latin I)

	HEX	8	9	A	B	C	D	E	F
HEX	BIN	1000	1001	1010	1011	1100	1101	1110	1111
0	0000	€ 128			° 176	À 192	Ð 208	à 224	đ 240
1	0001		‘ 145	í 161	± 177	Á 193	Ñ 209	á 225	ñ 241
2	0010	’ 130	’ 146	¢ 162	2 178	Â 194	Ò 210	â 226	ò 242
3	0011	f 131	“ 147	£ 163	3 179	Ã 195	Ó 211	ã 227	ó 243
4	0100	” 132	” 148	¤ 164	´ 180	Ä 196	Ô 212	ä 228	ô 244
5	0101	… 133	• 149	¥ 165	µ 181	Å 197	Ö 213	å 229	ö 245
6	0110	† 134	- 150	 166	¶ 182	Æ 198	Ø 214	æ 230	ø 246
7	0111	‡ 135	– 151	§ 167	• 183	Ç 199	× 215	ç 231	÷ 247
8	1000	^ 136	~ 152	¨ 168	˙ 184	È 200	Ø 216	è 232	ø 248
9	1001	‰ 137	™ 153	© 169	1 185	É 201	Ù 217	é 233	ù 249
A	1010	Š 138	š 154	à 170	ɑ 186	Ê 202	Ú 218	ê 234	ú 250
B	1011	‹ 139	› 155	« 171	» 187	Ë 203	Û 219	ë 235	û 251
C	1100	Œ 140	œ 156	¬ 172	¼ 188	Ĭ 204	Ü 220	ì 236	ü 252
D	1101			– 173	½ 189	Í 205	Ý 221	í 237	ý 253
E	1110	Ž 142	ž 158	® 174	¾ 190	Î 206	Þ 222	î 238	þ 254
F	1111		ÿ 159	– 175	¿ 191	Ï 207	ß 223	ï 239	ÿ 255

9. Page 17 - 866 (Cyrillic #2)

	HEX	8	9	A	B	C	D	E	F
HEX	BIN	1000	1001	1010	1011	1100	1101	1110	1111
0	0000	А 128	Р 144	а 160	 176	Л 192	⊥ 208	р 224	Ё 240
1	0001	Б 129	С 145	б 161	 177	⊥ 193	⊥ 209	с 225	ё 241
2	0010	В 130	Т 146	в 162	 178	⊥ 194	⊥ 210	т 226	ѐ 242
3	0011	Г 131	У 147	г 163	 179	⊥ 195	⊥ 211	у 227	ѓ 243
4	0100	Д 132	Ф 148	д 164	⊥ 180	— 196	⊥ 212	ф 228	ї 244
5	0101	Е 133	Х 149	е 165	⊥ 181	⊥ 197	⊥ 213	х 229	і 245
6	0110	Ж 134	Ц 150	ж 166	⊥ 182	⊥ 198	⊥ 214	ц 230	ÿ 246
7	0111	З 135	Ч 151	з 167	⊥ 183	⊥ 199	⊥ 215	ч 231	ÿ 247
8	1000	И 136	Ш 152	и 168	⊥ 184	⊥ 200	⊥ 216	ш 232	° 248
9	1001	Й 137	Щ 153	й 169	⊥ 185	⊥ 201	⊥ 217	щ 233	· 249
A	1010	К 138	Ъ 154	к 170	 186	⊥ 202	⊥ 218	ъ 234	· 250
B	1011	Л 139	Ы 155	л 171	⊥ 187	⊥ 203	■ 219	ы 235	√ 251
C	1100	М 140	Ь 156	м 172	⊥ 188	⊥ 204	■ 220	ь 236	№ 252
D	1101	Н 141	Э 157	н 173	⊥ 189	⊥ 205	■ 221	э 237	¤ 253
E	1110	О 142	Ю 158	о 174	⊥ 190	⊥ 206	■ 222	ю 238	■ 254
F	1111	П 143	Я 159	п 175	⊥ 191	⊥ 207	■ 223	я 239	SP 255

10. Page 18 - 852 (Latin 2)

	HEX	8	9	A	B	C	D	E	F
HEX	BIN	1000	1001	1010	1011	1100	1101	1110	1111
0	0000	Ç 128	É 144	á 160	█ 176	Ł 192	đ 208	Ó 224	- 240
1	0001	ü 129	Í 145	í 161	█ 177	Ł 193	Đ 209	β 225	“ 241
2	0010	é 130	Í 146	ó 162	█ 178	Ł 194	Đ 210	Ô 226	˘ 242
3	0011	â 131	ô 147	ú 163	 179	ł 195	Ě 211	Ń 227	ˇ 243
4	0100	ä 132	ö 148	À 164	 180	- 196	d' 212	ń 228	ˇ 244
5	0101	ù 133	Ì 149	ą 165	Á 181	+ 197	Ň 213	ň 229	§ 245
6	0110	ć 134	ł 150	ž 166	Â 182	Ǻ 198	í 214	š 230	+ 246
7	0111	ç 135	Ś 151	ž 167	Ě 183	ǻ 199	î 215	š 231	˘ 247
8	1000	ł 136	ś 152	Ę 168	Ş 184	Ł 200	ě 216	Ř 232	° 248
9	1001	ë 137	Ö 153	ę 169	 185	ł 201	ĵ 217	Ú 233	“ 249
A	1010	Ő 138	Ü 154	˘ 170	 186	Ł 202	ł 218	í 234	˘ 250
B	1011	ő 139	ű 155	ž 171	 187	Ł 203	█ 219	Ú 235	ú 251
C	1100	î 140	ť 156	č 172	 188	ł 204	█ 220	ý 236	Ř 252
D	1101	ž 141	ł 157	ş 173	ž 189	= 205	ł 221	Ý 237	ř 253
E	1110	Ä 142	x 158	« 174	ž 190	ł 206	Ű 222	ł 238	█ 254
F	1111	Ć 143	č 159	» 175	ł 191	α 207	█ 223	˘ 239	˘ 255

11. Page 19 - 858 (Euro)

	HEX	8	9	A	B	C	D	E	F
HEX	BIN	1000	1001	1010	1011	1100	1101	1110	1111
0	0000	Ç 128	É 144	á 160	☐ 176	Ł 192	ö 208	ó 224	– 240
1	0001	ü 129	æ 145	í 161	☐ 177	⊥ 193	ð 209	β 225	± 241
2	0010	é 130	Æ 146	ó 162	☐ 178	⊥ 194	Ê 210	Ô 226	= 242
3	0011	â 131	ô 147	ú 163	 179	† 195	Ë 211	Ò 227	¾ 243
4	0100	ä 132	ö 148	ñ 164	† 180	– 196	È 212	õ 228	¶ 244
5	0101	à 133	ò 149	Ñ 165	Á 181	+ 197	€ 213	Õ 229	§ 245
6	0110	á 134	û 150	a 166	À 182	ã 198	í 214	μ 230	÷ 246
7	0111	ç 135	ù 151	o 167	À 183	Ä 199	î 215	þ 231	· 247
8	1000	ê 136	ÿ 152	¿ 168	© 184	ℒ 200	ï 216	þ 232	° 248
9	1001	ë 137	Ö 153	® 169	≡ 185	ℒ 201	⌋ 217	Ú 233	ˆ 249
A	1010	è 138	Ü 154	¬ 170	 186	ℒ 202	⌈ 218	Ù 234	· 250
B	1011	ï 139	ø 155	1/2 171	⌈ 187	⌈ 203	■ 219	Ù 235	1 251
C	1100	î 140	£ 156	1/4 172	⌋ 188	⌈ 204	■ 220	ý 236	³ 252
D	1101	ì 141	ø 157	i 173	¢ 189	= 205	ì 221	Ý 237	² 253
E	1110	Ä 142	x 158	« 174	¥ 190	† 206	ì 222	– 238	▪ 254
F	1111	Å 143	f 159	» 175	⌈ 191	α 207	■ 223	· 239	SP 255

12. Page 21 - 862 (Hebrew DOS code)

	HEX	8	9	A	B	C	D	E	F
HEX	BIN	1000	1001	1010	1011	1100	1101	1110	1111
0	0000	א 128	ב 144	א 160	☐ 176	ל 192	⌌ 208	α 224	≡ 240
1	0001	ב 129	ס 145	í 161	☐ 177	⌌ 193	⌌ 209	β 225	± 241
2	0010	ג 130	ע 146	ó 162	☐ 178	⌌ 194	⌌ 210	Γ 226	≥ 242
3	0011	ד 131	ף 147	ú 163	 179	⌌ 195	⌌ 211	π 227	≤ 243
4	0100	ה 132	פ 148	ñ 164	⌌ 180	— 196	⌌ 212	Σ 228	∫ 244
5	0101	ו 133	ץ 149	Ñ 165	⌌ 181	⌌ 197	⌌ 213	σ 229	∫ 245
6	0110	ז 134	צ 150	a 166	⌌ 182	⌌ 198	⌌ 214	μ 230	÷ 246
7	0111	ח 135	ק 151	o 167	⌌ 183	⌌ 199	⌌ 215	τ 231	≈ 247
8	1000	ט 136	ר 152	ı 168	⌌ 184	⌌ 200	⌌ 216	Φ 232	° 248
9	1001	י 137	ש 153	ר 169	⌌ 185	⌌ 201	⌌ 217	Θ 233	· 249
A	1010	ך 138	ת 154	ר 170	⌌ 186	⌌ 202	⌌ 218	Ω 234	· 250
B	1011	כ 139	ץ 155	½ 171	⌌ 187	⌌ 203	■ 219	δ 235	√ 251
C	1100	ל 140	£ 156	¾ 172	⌌ 188	⌌ 204	■ 220	∞ 236	n 252
D	1101	ם 141	¥ 157	i 173	⌌ 189	⌌ 205	■ 221	φ 237	² 253
E	1110	נ 142	Pts 158	« 174	⌌ 190	⌌ 206	■ 222	ε 238	■ 254
F	1111	ס 143	f 159	» 175	⌌ 191	⌌ 207	■ 223	∩ 239	SP 255

13. Page 22 - 864 (Arabic)

	HEX	8	9	A	B	C	D	E	F
HEX	BIN	1000	1001	1010	1011	1100	1101	1110	1111
0	0000	° 128	β 144	NBSP 160	· 176	¢ 192	ذ 208	- 224	ـ 240
1	0001	· 129	∞ 145	— 161	٧ 177	ء 193	ر 209	ف 225	ـ 241
2	0010	· 130	∅ 146	آ 162	٢ 178	آ 194	ز 210	ق 226	ن 242
3	0011	√ 131	± 147	£ 163	٣ 179	أ 195	س 211	ك 227	ه 243
4	0100	▒ 132	½ 148	¤ 164	ε 180	ؤ 196	ش 212	ل 228	ه 244
5	0101	— 133	¼ 149	أ 165	ه 181	ع 197	ص 213	م 229	ي 245
6	0110	 134	≈ 150	— 166	٦ 182	ئ 198	ض 214	ن 230	ي 246
7	0111	⊕ 135	« 151	€ 167	٧ 183	ا 199	ط 215	ه 231	ذ 247
8	1000	⊕ 136	» 152	ا 168	٨ 184	ب 200	ظ 216	و 232	ق 248
9	1001	⊕ 137	لأ 153	ب 169	٩ 185	ة 201	ع 217	ي 233	لأ 249
A	1010	⊕ 138	لأ 154	ت 170	ف 186	ت 202	غ 218	ي 234	لأ 250
B	1011	⊕ 139	— 155	ث 171	؛ 187	ث 203	ا 219	ض 235	ل 251
C	1100	⊕ 140	— 156	، 172	س 188	ج 204	⊕ 220	ع 236	ك 252
D	1101	⊕ 141	لا 157	ج 173	ش 189	ح 205	÷ 221	غ 237	ي 253
E	1110	⊕ 142	لا 158	ح 174	ص 190	خ 206	× 222	غ 238	■ 254
F	1111	⊕ 143	لا 159	خ 175	؟ 191	د 207	ع 223	م 239	— 255

14. Page 23 - Thai character code 42

	HEX	8	9	A	B	C	D	E	F
HEX	BIN	1000	1001	1010	1011	1100	1101	1110	1111
0	0000	┌ 128	○ 144	 160	ฅ 176	ย 192	๒ 208	' 224	๒๓ 240
1	0001	┐ 129	๑ 145	ก 161	ฆ 177	ร 193	๓ 209	๑ 225	๒๔ 241
2	0010	└ 130	๒ 146	ข 162	ง 178	ฤ 194	๔ 210	๒ 226	๒๕ 242
3	0011	┘ 131	๓ 147	ค 163	จ 179	ล 195	๕ 211	๓ 227	๒๖ 243
4	0100	┌ 132	๔ 148	ฅ 164	ฉ 180	ว 196	๖ 212	๔ 228	๒๗ 244
5	0101	┐ 133	๕ 149	ง 165	ช 181	ศ 197	๗ 213	๕ 229	๒๘ 245
6	0110	└ 134	๖ 150	จ 166	ซ 182	ช 198	๘ 214	๖ 230	๒๙ 246
7	0111	┘ 135	๗ 151	ฉ 167	ฌ 183	ส 199	๙ 215	๗ 231	๓๐ 247
8	1000	┌ 136	๘ 152	ช 168	ญ 184	ห 200	๐ 216	๘ 232	๓๑ 248
9	1001	┐ 137	๙ 153	ฅ 169	ฎ 185	ฬ 201	๑ 217	๙ 233	๓๒ 249
A	1010	└ 138	๐ 154	ฆ 170	ฏ 186	อ 202	๒ 218	๐ 234	๓๓ 250
B	1011	█ 139	๑ 155	ง 171	ฐ 187	ฮ 203	๓ 219	๑ 235	๓๔ 251
C	1100	← 140	๒ 156	จ 172	ฑ 188	๕ 204	๔ 220	๒ 236	๓๕ 252
D	1101	↑ 141	๓ 157	ฉ 173	ฒ 189	๖ 205	๕ 221	๓ 237	๓๖ 253
E	1110	→ 142	๔ 158	ช 174	ณ 190	๗ 206	๖ 222	๔ 238	๓๗ 254
F	1111	↓ 143	๕ 159	ซ 175	ด 191	๘ 207	๗ 223	๕ 239	๓๘ 255

15. Page 24 - 1253 (Greek)

	HEX	8	9	A	B	C	D	E	F
HEX	BIN	1000	1001	1010	1011	1100	1101	1110	1111
0	0000	€ 128		NBSP 160	° 176	ı̇ 192	Π 208	Û 224	π 240
1	0001		‘ 145	• 161	± 177	Α 193	Ρ 209	α 225	ρ 241
2	0010	, 130	, 146	Α 162	² 178	Β 194		β 226	ς 242
3	0011	f 131	“ 147	£ 163	³ 179	Γ 195	Σ 211	ϝ 227	σ 243
4	0100	” 132	” 148	¤ 164	’ 180	Δ 196	Τ 212	δ 228	τ 244
5	0101	… 133	• 149	¥ 165	μ 181	Ε 197	Υ 213	ε 229	υ 245
6	0110	† 134	– 150	ı̇ 166	¶ 182	Ζ 198	Φ 214	ζ 230	φ 246
7	0111	‡ 135	— 151	§ 167	· 183	Η 199	Χ 215	η 231	χ 247
8	1000			¨ 168	Ε 184	Θ 200	Ψ 216	θ 232	ψ 248
9	1001	‰ 137	™ 153	© 169	Η 185	Ι 201	Ω 217	ι 233	ω 249
A	1010				Ι 186	Κ 202	Ϊ 218	κ 234	ϊ 250
B	1011	< 139	> 155	« 171	» 187	Λ 203	ÿ 219	λ 235	ÿ 251
C	1100			¬ 172	Ό 188	Μ 204	ά 220	μ 236	ό 252
D	1101			- 173	½ 189	Ν 205	έ 221	ν 237	ύ 253
E	1110			® 174	Υ 190	Ξ 206	ή 222	ξ 238	ώ 254
F	1111			— 175	Ω 191	Ο 207	ί 223	ο 239	



16. Page 25 - 1254 (Turkish)

	HEX	8	9	A	B	C	D	E	F
HEX	BIN	1000	1001	1010	1011	1100	1101	1110	1111
0	0000	€ 128		NBSP 160	° 176	À 192	Ğ 208	à 224	ğ 240
1	0001		‘ 145	ı 161	± 177	Á 193	Ñ 209	á 225	ñ 241
2	0010	, 130	, 146	ç 162	² 178	Â 194	Ò 210	â 226	ò 242
3	0011	f 131	“ 147	£ 163	³ 179	Ã 195	Ó 211	ã 227	ó 243
4	0100	” 132	” 148	¤ 164	´ 180	Ä 196	Ô 212	ä 228	ô 244
5	0101	… 133	• 149	¥ 165	µ 181	Å 197	Õ 213	å 229	õ 245
6	0110	† 134	— 150	ı 166	¶ 182	Æ 198	Ö 214	æ 230	ö 246
7	0111	‡ 135	— 151	§ 167	· 183	Ç 199	× 215	ç 231	÷ 247
8	1000	^ 136	~ 152	¨ 168	˘ 184	È 200	Ø 216	è 232	ø 248
9	1001	‰ 137	™ 153	© 169	¹ 185	É 201	Ù 217	é 233	ù 249
A	1010	Š 138	š 154	ª 170	º 186	Ê 202	Ú 218	ê 234	ú 250
B	1011	‹ 139	› 155	« 171	» 187	Ë 203	Û 219	ë 235	û 251
C	1100	Œ 140	œ 156	¬ 172	¼ 188	Ì 204	Ü 220	ì 236	ü 252
D	1101			- 173	½ 189	Í 205	İ 221	í 237	ı 253
E	1110			® 174	¾ 190	Î 206	Ş 222	î 238	ş 254
F	1111		ÿ 159	— 175	¿ 191	Ï 207	ß 223	ï 239	ÿ 255

17. Page 26 - 1257 (Baltic)

	HEX	8	9	A	B	C	D	E	F
HEX	BIN	1000	1001	1010	1011	1100	1101	1110	1111
0	0000	€ 128		NBSP 160	° 176	À 192	Š 208	ą 224	š 240
1	0001		‘ 145		± 177	Ĺ 193	Ń 209	į 225	ń 241
2	0010	, 130	, 146	¢ 162	² 178	Ā 194	Ņ 210	ā 226	ņ 242
3	0011		“ 147	£ 163	³ 179	Ć 195	Ó 211	ć 227	ó 243
4	0100	” 132	” 148	¤ 164	´ 180	Ä 196	Ō 212	ä 228	ō 244
5	0101	… 133	• 149		μ 181	Å 197	Õ 213	å 229	õ 245
6	0110	† 134	— 150	ı 166	¶ 182	Ę 198	Ö 214	ę 230	ö 246
7	0111	‡ 135	— 151	§ 167	· 183	Ē 199	× 215	ē 231	÷ 247
8	1000			Ø 168	ø 184	Č 200	Ų 216	č 232	ų 248
9	1001	‰ 137	™ 153	© 169	¹ 185	É 201	Ł 217	é 233	ł 249
A	1010			Ŕ 170	ŗ 186	Ž 202	Ś 218	ż 234	ś 250
B	1011	‹ 139	› 155	« 171	» 187	Ĕ 203	Ū 219	ė 235	ū 251
C	1100			¬ 172	¼ 188	Ģ 204	Ü 220	ģ 236	ü 252
D	1101	¨ 141	— 157	- 173	½ 189	Ķ 205	Ž 221	ķ 237	ž 253
E	1110	˘ 142	˘ 158	® 174	¾ 190	Ī 206	Ž 222	ī 238	ž 254
F	1111	˙ 143		Æ 175	æ 191	Ļ 207	ß 223	ļ 239	· 255









18. Page 27 - Farsi

	HEX	8	9	A	B	C	D	E	F
HEX	BIN	1000	1001	1010	1011	1100	1101	1110	1111
0	0000	۰ 128	ا 144	خ 160	 176	ل 192	ل 208	ظ 224	گ 240
1	0001	۱ 129	ب 145	ح 161	 177	ل 193	ل 209	ع 225	ل 241
2	0010	۲ 130	ب 146	د 162	 178	ل 194	ل 210	ع 226	لا 242
3	0011	۳ 131	ب 147	ذ 163	 179	ل 195	ل 211	ع 227	ل 243
4	0100	۴ 132	پ 148	ر 164	ل 180	— 196	ل 212	ع 228	م 244
5	0101	۵ 133	پ 149	ز 165	ل 181	+ 197	ل 213	غ 229	م 245
6	0110	۶ 134	ت 150	ث 166	ل 182	ل 198	ل 214	غ 230	ن 246
7	0111	۷ 135	ن 151	س 167	ل 183	ل 199	ل 215	غ 231	ن 247
8	1000	۸ 136	ث 152	س 168	ل 184	ل 200	ل 216	غ 232	و 248
9	1001	۹ 137	ث 153	ش 169	ل 185	ل 201	ل 217	ف 233	ه 249
A	1010	، 138	ج 154	ش 170	ل 186	ل 202	ل 218	ف 234	ه 250
B	1011	، 139	چ 155	ص 171	ل 187	ل 203	■ 219	ق 235	ه 251
C	1100	؟ 140	چ 156	ط 172	ل 188	ل 204	■ 220	ق 236	ی 252
D	1101	آ 141	چ 157	ض 173	ل 189	ل 205	■ 221	ک 237	ی 253
E	1110	ک 142	ح 158	ظ 174	ل 190	ل 206	■ 222	ک 238	پ 254
F	1111	ع 143	ح 159	ط 175	ل 191	ل 207	■ 223	گ 239	255

19. Page 28 - 1251 (Cyrillic)

	HEX	8	9	A	B	C	D	E	F
HEX	BIN	1000	1001	1010	1011	1100	1101	1110	1111
0	0000	Ѓ 128	ђ 144	NBSP 160	° 176	А 192	Р 208	а 224	р 240
1	0001	Ѕ 129	‘ 145	Ў 161	± 177	Б 193	С 209	б 225	с 241
2	0010	, 130	, 146	ў 162	І 178	В 194	Т 210	в 226	т 242
3	0011	Ї 131	“ 147	Ј 163	і 179	Г 195	У 211	г 227	у 243
4	0100	” 132	” 148	ѡ 164	г 180	Д 196	Ф 212	д 228	ф 244
5	0101	… 133	• 149	Г 165	μ 181	Е 197	Х 213	е 229	х 245
6	0110	† 134	— 150	і 166	¶ 182	Ж 198	Ц 214	ж 230	ц 246
7	0111	‡ 135	— 151	§ 167	· 183	З 199	Ч 215	з 231	ч 247
8	1000	€ 136	™ 152	Ё 168	ё 184	И 200	Ш 216	и 232	ш 248
9	1001	‰ 137	™ 153	© 169	№ 185	Й 201	Щ 217	й 233	щ 249
A	1010	Љ 138	љ 154	Є 170	є 186	К 202	Ъ 218	к 234	ъ 250
B	1011	< 139	> 155	« 171	» 187	Л 203	Ы 219	л 235	ы 251
C	1100	Њ 140	њ 156	Ў 172	ј 188	М 204	Ь 220	м 236	ь 252
D	1101	Ќ 141	ќ 157	- 173	ѕ 189	Н 205	Э 221	н 237	э 253
E	1110	Ў 142	ў 158	® 174	ѕ 190	О 206	Ю 222	о 238	ю 254
F	1111	Ѡ 143	ѡ 159	İ 175	ï 191	П 207	Я 223	п 239	я 255

20. Page 29 - 737 (Greek)

	HEX	8	9	A	B	C	D	E	F
HEX	BIN	1000	1001	1010	1011	1100	1101	1110	1111
0	0000	Α 128	Ρ 144	ι 160	 176	Λ 192	⊥ 208	ω 224	Ω 240
1	0001	Β 129	Σ 145	κ 161	 177	⊥ 193	⊥ 209	ά 225	± 241
2	0010	Γ 130	Τ 146	λ 162	 178	⊥ 194	⊥ 210	έ 226	≥ 242
3	0011	Δ 131	Υ 147	μ 163	 179	⊥ 195	⊥ 211	ή 227	≤ 243
4	0100	Ε 132	Φ 148	ν 164	⊥ 180	— 196	⊥ 212	ϊ 228	Ï 244
5	0101	Ζ 133	Χ 149	ξ 165	⊥ 181	⊥ 197	⊥ 213	ί 229	ÿ 245
6	0110	Η 134	Ψ 150	ο 166	⊥ 182	⊥ 198	⊥ 214	ό 230	÷ 246
7	0111	Θ 135	Ω 151	π 167	⊥ 183	⊥ 199	⊥ 215	ύ 231	≈ 247
8	1000	Ι 136	α 152	ρ 168	⊥ 184	⊥ 200	⊥ 216	ϋ 232	° 248
9	1001	Κ 137	β 153	σ 169	⊥ 185	⊥ 201	⊥ 217	ώ 233	· 249
A	1010	Λ 138	γ 154	ς 170	⊥ 186	⊥ 202	⊥ 218	Α 234	· 250
B	1011	Μ 139	δ 155	τ 171	⊥ 187	⊥ 203	 219	Ε 235	√ 251
C	1100	Ν 140	ε 156	υ 172	⊥ 188	⊥ 204	 220	Η 236	η 252
D	1101	Ξ 141	ζ 157	φ 173	⊥ 189	⊥ 205	 221	Ι 237	² 253
E	1110	Ο 142	η 158	χ 174	⊥ 190	⊥ 206	 222	Ο 238	 254
F	1111	Π 143	θ 159	ψ 175	⊥ 191	⊥ 207	 223	Υ 239	SP 255

21. Page 30 - 775 (Baltic)

	HEX	8	9	A	B	C	D	E	F
HEX	BIN	1000	1001	1010	1011	1100	1101	1110	1111
0	0000	Ć 128	É 144	Ā 160	▒ 176	Ł 192	ą 208	Ó 224	- 240
1	0001	Û 129	æ 145	Ī 161	▒ 177	ł 193	č 209	ß 225	± 241
2	0010	é 130	Æ 146	ó 162	▒ 178	ṽ 194	ę 210	Ō 226	“ 242
3	0011	ā 131	ō 147	ž 163	 179	ł 195	è 211	Ń 227	¾ 243
4	0100	ä 132	ö 148	ž 164	ł 180	— 196	ì 212	õ 228	¶ 244
5	0101	ğ 133	Ĝ 149	ž 165	À 181	ł 197	š 213	Õ 229	§ 245
6	0110	å 134	ç 150	” 166	Č 182	ų 198	ų 214	μ 230	÷ 246
7	0111	ć 135	Ś 151	ı 167	Ę 183	Ū 199	ū 215	ń 231	” 247
8	1000	ł 136	ś 152	© 168	È 184	Ł 200	ž 216	Ɔ 232	° 248
9	1001	ē 137	Ö 153	® 169	¶ 185	ł 201	ł 217	ķ 233	· 249
A	1010	Ŕ 138	Ü 154	ł 170	ł 186	ł 202	ł 218	Ł 234	· 250
B	1011	ł 139	ø 155	½ 171	ł 187	ł 203	▀ 219	ł 235	¹ 251
C	1100	ī 140	£ 156	¼ 172	ł 188	ł 204	▀ 220	ņ 236	³ 252
D	1101	ž 141	Ø 157	ł 173	ł 189	ł 205	▀ 221	Ē 237	² 253
E	1110	Ä 142	× 158	« 174	Š 190	ł 206	▀ 222	Ņ 238	▀ 254
F	1111	Å 143	α 159	» 175	ł 191	Ž 207	▀ 223	, 239	SP 255

22. Page 31 - Thai character code 14

	HEX	8	9	A	B	C	D	E	F
HEX	BIN	1000	1001	1010	1011	1100	1101	1110	1111
0	0000	┌ 128	┌ 144	┌ 160	┌ 176	┌ 192	┌ 208	┌ 224	┌ 240
1	0001	└ 129	└ 145	└ 161	└ 177	└ 193	└ 209	└ 225	└ 241
2	0010	└ 130	└ 146	└ 162	└ 178	└ 194	└ 210	└ 226	└ 242
3	0011	└ 131	└ 147	└ 163	└ 179	└ 195	└ 211	└ 227	└ 243
4	0100	└ 132	└ 148	└ 164	└ 180	└ 196	└ 212	└ 228	└ 244
5	0101	└ 133	└ 149	└ 165	└ 181	└ 197	└ 213	└ 229	└ 245
6	0110	└ 134	└ 150	└ 166	└ 182	└ 198	└ 214	└ 230	└ 246
7	0111	└ 135	└ 151	└ 167	└ 183	└ 199	└ 215	└ 231	└ 247
8	1000	└ 136	└ 152	└ 168	└ 184	└ 200	└ 216	└ 232	└ 248
9	1001	└ 137	└ 153	└ 169	└ 185	└ 201	└ 217	└ 233	└ 249
A	1010	└ 138	└ 154	└ 170	└ 186	└ 202	└ 218	└ 234	└ 250
B	1011	└ 139	└ 155	└ 171	└ 187	└ 203	└ 219	└ 235	└ 251
C	1100	└ 140	└ 156	└ 172	└ 188	└ 204	└ 220	└ 236	└ 252
D	1101	└ 141	└ 157	└ 173	└ 189	└ 205	└ 221	└ 237	└ 253
E	1110	└ 142	└ 158	└ 174	└ 190	└ 206	└ 222	└ 238	└ 254
F	1111	└ 143	└ 159	└ 175	└ 191	└ 207	└ 223	└ 239	└ 255

23. Page 32 - Hebrew Old code

	HEX	0	1	2	3	4	5	6	7
HEX	BIN	0000	0001	0010	0011	0100	0101	0110	0111
0	0000	00	16	32	48	64	80	96	112
1	0001	01	17	33	49	65	81	97	113
2	0010	02	18	34	50	66	82	98	114
3	0011	03	19	35	51	67	83	99	115
4	0100	04	20	36	52	68	84	100	116
5	0101	05	21	37	53	69	85	101	117
6	0110	06	22	38	54	70	86	102	118
7	0111	07	23	39	55	71	87	103	119
8	1000	08	24	40	56	72	88	104	120
9	1001	09	25	41	57	73	89	105	121
A	1010	10	26	42	58	74	90	106	122
B	1011	11	27	43	59	75	91	107	123
C	1100	12	28	44	60	76	92	108	124
D	1101	13	29	45	61	77	93	109	125
E	1110	14	30	46	62	78	94	110	126
F	1111	15	31	47	63	79	95	111	127

24. Page 33 - 1255 (Hebrew New code)

	HEX	8	9	A	B	C	D	E	F
HEX	BIN	1000	1001	1010	1011	1100	1101	1110	1111
0	0000	€ 128		NBSP 160	° 176	· 192	 208	א 224	ן 240
1	0001		‘ 145	ı 161	± 177	“ 193	’ 209	ב 225	ס 241
2	0010	, 130	, 146	¢ 162	² 178	“ 194	· 210	ג 226	ע 242
3	0011	f 131	“ 147	£ 163	³ 179	“ 195	: 211	ד 227	ף 243
4	0100	” 132	” 148	₪ 164	’ 180	· 196	ן 212	ה 228	פ 244
5	0101	… 133	• 149	¥ 165	μ 181	“ 197	ן 213	ו 229	ץ 245
6	0110	† 134	– 150	 166	¶ 182	“ 198	” 214	ז 230	צ 246
7	0111	‡ 135	— 151	§ 167	· 183	· 199	’ 215	ח 231	ק 247
8	1000	^ 136	~ 152	“ 168	ˆ 184	ˆ 200	” 216	ט 232	ך 248
9	1001	‰ 137	™ 153	© 169	¹ 185	· 201	· 217	י 233	ש 249
A	1010			× 170	÷ 186			ך 234	ת 250
B	1011	< 139	> 155	« 171	» 187	“ 203	’ 219	כ 235	
C	1100			¬ 172	¼ 188	· 204	· 220	ל 236	
D	1101			- 173	½ 189	· 205	· 221	ם 237	LTR 253
E	1110			® 174	¾ 190	- 206	· 222	נ 238	RTL 254
F	1111			— 175	¿ 191	- 207	· 223	ן 239	







25. Page 34 - Thai character code 11

	HEX	8	9	A	B	C	D	E	F
HEX	BIN	1000	1001	1010	1011	1100	1101	1110	1111
0	0000	๕ - 128	๕+ 144	๖ 160	๖ 176	๗ 192	๘ 208	๘ 224	๐ 240
1	0001	๕๕ 129	๕- 145	๗ 161	๗ 177	๘ 193	๙ 209	๙ 225	๑ 241
2	0010	๕๖ 130	๕๕ 146	๘ 162	๘ 178	๙ 194	๙ 210	๐ 226	๒ 242
3	0011	๕+ 131	๕๖ 147	๘ 163	๙ 179	๙ 195	๐ 211	๐ 227	๓ 243
4	0100	๕- 132	๕๕ 148	๙ 164	๙ 180	๐ 196	๐ 212	๑ 228	๔ 244
5	0101	๕๕ 133	๕- 149	๙ 165	๐ 181	๐ 197	๑ 213	๑ 229	๕ 245
6	0110	๕๖ 134	๕๕ 150	๐ 166	๐ 182	๑ 198	๑ 214	๑ 230	๖ 246
7	0111	๕๕ 135	๕๖ 151	๐ 167	๑ 183	๑ 199	๑ 215	๑ 231	๗ 247
8	1000	๕- 136	๕+ 152	๑ 168	๑ 184	๑ 200	๑ 216	๑ 232	๘ 248
9	1001	๕- 137	๕+ 153	๑ 169	๑ 185	๑ 201	๑ 217	๑ 233	๙ 249
A	1010	๕๕ 138	๕+ 154	๑ 170	๑ 186	๑ 202	๑ 218	๑ 234	๐ 250
B	1011	๕๖ 139	๕+ 155	๑ 171	๑ 187	๑ 203	๑ 219	๑ 235	๑ 251
C	1100	๕๕ 140	๕+ 156	๑ 172	๑ 188	๑ 204	๑ 220	๑ 236	๑ 252
D	1101	๕- 141	๕+ 157	๑ 173	๑ 189	๑ 205	๑ 221	๑ 237	๑ 253
E	1110	๕๕ 142	๕+ 158	๑ 174	๑ 190	๑ 206	๑ 222	๑ 238	๑ 254
F	1111	๕๕ 143	๕+ 159	๑ 175	๑ 191	๑ 207	๑ 223	๑ 239	๑ 255

26. Page 35 - Thai character code 18

	HEX	8	9	A	B	C	D	E	F
HEX	BIN	1000	1001	1010	1011	1100	1101	1110	1111
0	0000	┌ 128	๖ 144	๖ 160	๖ 176	๖ 192	๖ 208	๖ 224	๖ 240
1	0001	┐ 129	๗ 145	๗ 161	๗ 177	๗ 193	๗ 209	๗ 225	๗ 241
2	0010	└ 130	๘ 146	๘ 162	๘ 178	๘ 194	๘ 210	๘ 226	๘ 242
3	0011	┘ 131	๙ 147	๙ 163	๙ 179	๙ 195	๙ 211	๙ 227	๙ 243
4	0100	┌ 132	๑๐ 148	๑๐ 164	๑๐ 180	๑๐ 196	๑๐ 212	๑๐ 228	๑๐ 244
5	0101	┐ 133	๑๑ 149	๑๑ 165	๑๑ 181	๑๑ 197	๑๑ 213	๑๑ 229	๑๑ 245
6	0110	└ 134	๑๒ 150	๑๒ 166	๑๒ 182	๑๒ 198	๑๒ 214	๑๒ 230	๑๒ 246
7	0111	┘ 135	๑๓ 151	๑๓ 167	๑๓ 183	๑๓ 199	๑๓ 215	๑๓ 231	๑๓ 247
8	1000	┌ 136	๑๔ 152	๑๔ 168	๑๔ 184	๑๔ 200	๑๔ 216	๑๔ 232	๑๔ 248
9	1001	┐ 137	๑๕ 153	๑๕ 169	๑๕ 185	๑๕ 201	๑๕ 217	๑๕ 233	๑๕ 249
A	1010	└ 138	๑๖ 154	๑๖ 170	๑๖ 186	๑๖ 202	๑๖ 218	๑๖ 234	๑๖ 250
B	1011	┘ 139	๑๗ 155	๑๗ 171	๑๗ 187	๑๗ 203	๑๗ 219	๑๗ 235	๑๗ 251
C	1100	← 140	๑๘ 156	๑๘ 172	๑๘ 188	๑๘ 204	๑๘ 220	๑๘ 236	๑๘ 252
D	1101	↑ 141	๑๙ 157	๑๙ 173	๑๙ 189	๑๙ 205	๑๙ 221	๑๙ 237	๑๙ 253
E	1110	→ 142	๒๐ 158	๒๐ 174	๒๐ 190	๒๐ 206	๒๐ 222	๒๐ 238	๒๐ 254
F	1111	↓ 143	๒๑ 159	๒๑ 175	๒๑ 191	๒๑ 207	๒๑ 223	๒๑ 239	๒๑ 255

27. Page 36 - 855 (Cyrillic)

	HEX	8	9	A	B	C	D	E	F
HEX	BIN	1000	1001	1010	1011	1100	1101	1110	1111
0	0000	ђ 128	љ 144	а 160	 176	Љ 192	Л 208	Я 224	- 240
1	0001	Ђ 129	Љ 145	А 161	 177	Љ 193	Л 209	р 225	ы 241
2	0010	ѓ 130	њ 146	б 162	 178	Т 194	М 210	Р 226	Ы 242
3	0011	Ѓ 131	Њ 147	Б 163	 179	Ѡ 195	М 211	с 227	З 243
4	0100	ё 132	ђ 148	ц 164	† 180	— 196	н 212	С 228	З 244
5	0101	Ё 133	Ђ 149	Ц 165	х 181	† 197	Н 213	т 229	ш 245
6	0110	е 134	ќ 150	д 166	Х 182	к 198	о 214	Т 230	Ш 246
7	0111	Е 135	Ќ 151	Д 167	и 183	К 199	О 215	у 231	э 247
8	1000	ѕ 136	ђ 152	е 168	И 184	Љ 200	п 216	У 232	Э 248
9	1001	Ѕ 137	Ђ 153	Е 169	 185	Ѧ 201	Ј 217	ж 233	Щ 249
A	1010	і 138	ц 154	ф 170	 186	Љ 202	Г 218	Ж 234	Щ 250
B	1011	І 139	Ц 155	Ф 171	 187	Ѧ 203	 219	В 235	Ч 251
C	1100	ї 140	ю 156	Г 172	 188	Ѧ 204	 220	В 236	Ч 252
D	1101	Ї 141	Ю 157	Г 173	й 189	= 205	П 221	ь 237	§ 253
E	1110	ј 142	ъ 158	« 174	Й 190	 206	я 222	Ь 238	■ 254
F	1111	Ј 143	Ъ 159	» 175	Г 191	Ѧ 207	 223	№ 239	 255

28. Page 37 - 857 (Turkish)

	HEX	8	9	A	B	C	D	E	F
HEX	BIN	1000	1001	1010	1011	1100	1101	1110	1111
0	0000	Ç 128	É 144	á 160	◼ 176	L 192	o 208	Ó 224	- 240
1	0001	ü 129	æ 145	í 161	◼ 177	⊥ 193	a 209	ß 225	± 241
2	0010	é 130	Æ 146	ó 162	◼ 178	⊥ 194	Ê 210	Ô 226	
3	0011	â 131	ô 147	ú 163	 179	† 195	Ë 211	Ò 227	¾ 243
4	0100	ä 132	ö 148	ñ 164	† 180	- 196	È 212	õ 228	¶ 244
5	0101	à 133	ò 149	Ñ 165	Á 181	† 197		Õ 229	§ 245
6	0110	å 134	û 150	Ǧ 166	Â 182	ã 198	Í 214	μ 230	÷ 246
7	0111	ç 135	ù 151	ǧ 167	À 183	Ã 199	Î 215		· 247
8	1000	ê 136	ï 152	ı 168	© 184	ℒ 200	Ï 216	× 232	° 248
9	1001	ë 137	Ö 153	® 169	≡ 185	℞ 201	⋈ 217	Ú 233	¨ 249
A	1010	è 138	Ü 154	¬ 170	≡ 186	≡ 202	⋈ 218	Û 234	· 250
B	1011	ï 139	ø 155	½ 171	¶ 187	¶ 203	◼ 219	Ü 235	¹ 251
C	1100	î 140	£ 156	¼ 172	¶ 188	¶ 204	◼ 220	ì 236	³ 252
D	1101	ı 141	Ø 157	ı 173	é 189	= 205	ı 221	ÿ 237	² 253
E	1110	Ä 142	Ş 158	« 174	¥ 190	≡ 206	İ 222	- 238	■ 254
F	1111	Å 143	ş 159	» 175	₯ 191	○ 207	◼ 223	´ 239	

29. Page 38 - 928 (Greek)

	HEX	8	9	A	B	C	D	E	F
HEX	BIN	1000	1001	1010	1011	1100	1101	1110	1111
0	0000	128	144	160	176	192	208	224	240
1	0001	129	145	161	177	193	209	225	241
2	0010	130	146	162	178	194	210	226	242
3	0011	131	147	163	179	195	211	227	243
4	0100	132	148	164	180	196	212	228	244
5	0101	133	149	165	181	197	213	229	245
6	0110	134	150	166	182	198	214	230	246
7	0111	135	151	167	183	199	215	231	247
8	1000	136	152	168	184	200	216	232	248
9	1001	137	153	169	185	201	217	233	249
A	1010	138	154	170	186	202	218	234	250
B	1011	139	155	171	187	203	219	235	251
C	1100	140	156	172	188	204	220	236	252
D	1101	141	157	173	189	205	221	237	253
E	1110	142	158	174	190	206	222	238	254
F	1111	143	159	175	191	207	223	239	255

30. Page 39 - Thai 16

	HEX	8	9	A	B	C	D	E	F
HEX	BIN	1000	1001	1010	1011	1100	1101	1110	1111
0	0000	┌ 128	ໂ 144	 160	๙ 176	ภ 192	ะ 208	เ 224	๐ 240
1	0001	└ 129	ใ 145	ก 161	ท 177	ม 193	ุ 209	แ 225	๑ 241
2	0010	┌ 130	๕ 146	ข 162	ฒ 178	ย 194	า 210	ำ 226	๒ 242
3	0011	└ 131	ะ 147	ช 163	ณ 179	ร 195	ำ 211	๑ 227	๓ 243
4	0100	┌ 132	๕ 148	ค 164	ด 180	ถ 196	า 212	ท 228	๔ 244
5	0101	└ 133	๕ 149	ค 165	ด 181	ล 197	า 213	า 229	๕ 245
6	0110	┌ 134	๕ 150	ฆ 166	ถ 182	ภ 198	า 214	า 230	๖ 246
7	0111	└ 135	๕ 151	ง 167	ท 183	ว 199	า 215	๕ 231	๗ 247
8	1000	┌ 136	๕ 152	จ 168	ช 184	ศ 200	า 216	า 232	๘ 248
9	1001	└ 137	๕ 153	ฉ 169	น 185	ษ 201	า 217	๕ 233	๙ 249
A	1010	┌ 138	๕ 154	ช 170	บ 186	ส 202	า 218	๕ 234	๐ 250
B	1011	█ 139	๕ 155	ช 171	ป 187	ท 203	า 219	๕ 235	๑ 251
C	1100	← 140	๕ 156	ณ 172	ผ 188	ฬ 204	า 220	๕ 236	๒ 252
D	1101	↑ 141	๕ 157	ญ 173	ฝ 189	อ 205	า 221	๕ 237	๓ 253
E	1110	→ 142	๕ 158	ฎ 174	พ 190	ฮ 206	๕ 222	๕ 238	๔ 254
F	1111	↓ 143	๕ 159	ฏ 175	ฟ 191	า 207	๕ 223	๕ 239	๕ 255

31. Page 40 - 1256 (Arabic)

	HEX	8	9	A	B	C	D	E	F
HEX	BIN	1000	1001	1010	1011	1100	1101	1110	1111
0	0000	€ 128	گ 144	° 160	□ 176	□ 192	ذ 208	à 224	° 240
1	0001	پ 129	‘ 145	، 161	± 177	ء 193	ر 209	ل 225	” 241
2	0010	، 130	’ 146	¢ 162	² 178	آ 194	ز 210	â 226	° 242
3	0011	f 131	“ 147	£ 163	³ 179	أ 195	س 211	م 227	° 243
4	0100	” 132	” 148	¤ 164	´ 180	ؤ 196	ش 212	ن 228	ô 244
5	0101	... 133	• 149	¥ 165	µ 181	إ 197	ص 213	ه 229	° 245
6	0110	† 134	— 150	¡ 166	¶ 182	ئ 198	ض 214	و 230	° 246
7	0111	‡ 135	— 151	§ 167	· 183	ا 199	× 215	ç 231	÷ 247
8	1000	^ 136	ك 152	¨ 168	د 184	ب 200	ط 216	è 232	° 248
9	1001	‰ 137	™ 153	© 169	¹ 185	ة 201	ظ 217	é 233	ù 249
A	1010	□ 138	□ 154	□ 170	؛ 186	ت 202	ع 218	ê 234	° 250
B	1011	‹ 139	› 155	« 171	» 187	ث 203	غ 219	ë 235	û 251
C	1100	œ 140	œ 156	¬ 172	¼ 188	ج 204	- 220	ى 236	ü 252
D	1101	چ 141	° 157	- 173	½ 189	ح 205	ف 221	ي 237	° 253
E	1110	ژ 142	° 158	® 174	¾ 190	خ 206	ق 222	î 238	° 254
F	1111	□ 143	□ 159	— 175	؟ 191	د 207	ك 223	ï 239	□ 255

32. Page 41 - 1258 (Vietnam)

	HEX	8	9	A	B	C	D	E	F
HEX	BIN	1000	1001	1010	1011	1100	1101	1110	1111
0	0000	€ 128			° 176	À 192	Đ 208	à 224	đ 240
1	0001		‘ 145	ì 161	± 177	Á 193	Ñ 209	á 225	ñ 241
2	0010	, 130	’ 146	ø 162	2 178	Â 194	ò 210	â 226	ó 242
3	0011	f 131	“ 147	£ 163	3 179	Ã 195	Ó 211	ã 227	ô 243
4	0100	” 132	” 148	¤ 164	´ 180	Ä 196	Ô 212	ä 228	õ 244
5	0101	… 133	• 149	¥ 165	µ 181	Å 197	Õ 213	å 229	ö 245
6	0110	† 134	- 150	¦ 166	¶ 182	Æ 198	Ö 214	æ 230	ö 246
7	0111	‡ 135	– 151	§ 167	• 183	Ç 199	x 215	ç 231	÷ 247
8	1000	^ 136	~ 152	" 168	· 184	È 200	Ø 216	è 232	ø 248
9	1001	‰ 137	™ 153	© 169	1 185	É 201	Ù 217	é 233	ù 249
A	1010			à 170	ó 186	Ê 202	Ú 218	ê 234	ú 250
B	1011	‹ 139	› 155	« 171	» 187	Ë 203	Û 219	ë 235	û 251
C	1100	œ 140	œ 156	¬ 172	¼ 188	ì 204	Ü 220	ü 236	ü 252
D	1101			– 173	½ 189	í 205	Ū 221	í 237	Ū 253
E	1110			® 174	¾ 190	î 206	ÿ 222	î 238	ÿ 254
F	1111		ÿ 159	– 175	¿ 191	ï 207	ß 223	ï 239	ÿ 255

33. Page 42 - Khmer (Cambodia)

	HEX	8	9	A	B	C	D	E	F
HEX	BIN	1000	1001	1010	1011	1100	1101	1110	1111
0	0000	ក 128	ថ 144	ហ 160	ព 176	ព្យ 192	ុ 208	០ 224	០ 240
1	0001	ខ 129	ទ 145	ឡ 161	ខ្ម 177	េ 193	ំ 209	១ 225	្ម 241
2	0010	គ 130	ធ 146	អ 162	ច 178	ៃ 194	្រ 210	២ 226	្រ 242
3	0011	ឃ 131	ង 147	អ 163	ខ្ម 179	ៃ 195	ំ 211	៣ 227	្ម 243
4	0100	ង 132	ប 148	អា 164	KIV AQ 180	ៅ 196	្រ 212	៤ 228	្រ 244
5	0101	ច 133	ង 149	ត 165	KIV AA 181	ៅ 197	្រ 213	៥ 229	្រ 245
6	0110	ឆ 134	ព 150	ស្រ 166	្រ 182	ំ 198	្រ 214	៦ 230	្រ 246
7	0111	ជ 135	ភ 151	ឧ 167	ំ 183	្រ 199	្រ 215	៧ 231	្រ 247
8	1000	ឈ 136	ម 152	ឧ 168	ំ 184	្រ 200	្រ 216	៨ 232	្រ 248
9	1001	ញ 137	យ 153	ឌ 169	ំ 185	្រ 201	្រ 217	៩ 233	្រ 249
A	1010	ដ 138	រ 154	ឌ 170	ំ 186	្រ 202	្រ 218		250
B	1011	ថ 139	ល 155	ប្រ 171	ំ 187	្រ 203	្រ 219	235	251
C	1100	ខ 140	រ 156	ប្រ 172	ំ 188	្រ 204	្រ 220	236	252
D	1101	ផ 141	ង 157	ព្យ 173	ំ 189	្រ 205	្រ 221	237	253
E	1110	ណា 142	ថ 158	ព្យ 174	ំ 190	្រ 206	្រ 222	238	254
F	1111	ត 143	ស 159	ង 175	្រ 191	្រ 207	្រ 223	239	255

34. Page 47 - 1250 (Czech)

	HEX	8	9	A	B	C	D	E	F
HEX	BIN	1000	1001	1010	1011	1100	1101	1110	1111
0	0000	€ 128		NBSP 160	° 176	Ř 192	Đ 208	ř 224	ď 240
1	0001		‘ 145	ˇ 161	± 177	Á 193	Ň 209	á 225	ň 241
2	0010	, 130	, 146	˘ 162	˘ 178	Ā 194	Ň 210	â 226	ň 242
3	0011	f 131	“ 147	£ 163	ł 179	Ǻ 195	Ó 211	ǻ 227	ó 243
4	0100	” 132	” 148	α 164	˘ 180	Ǻ 196	Ô 212	ä 228	ô 244
5	0101	… 133	• 149	Α 165	μ 181	Ĺ 197	Õ 213	í 229	õ 245
6	0110	† 134	— 150	¡ 166	¶ 182	Ć 198	Ö 214	ć 230	ö 246
7	0111	‡ 135	— 151	§ 167	· 183	Ç 199	× 215	ç 231	÷ 247
8	1000	^ 136	~ 152	¨ 168	˘ 184	Č 200	Ř 216	č 232	ř 248
9	1001	‰ 137	™ 153	© 169	ą 185	É 201	Û 217	é 233	ű 249
A	1010	Š 138	š 154	Ş 170	ş 186	Ę 202	Ú 218	ę 234	ú 250
B	1011	< 139	> 155	« 171	» 187	Ě 203	Ů 219	ě 235	ů 251
C	1100	Ś 140	ś 156	¬ 172	Ł 188	Ě 204	Ü 220	ś 236	ü 252
D	1101	Ť 141	ť 157	- 173	" 189	Í 205	Ý 221	í 237	ý 253
E	1110	Ž 142	ž 158	® 174	ł 190	Î 206	Ț 222	î 238	ț 254
F	1111	Ž 143	ž 159	Ž 175	ž 191	Ď 207	ß 223	ď 239	· 255

35. International character code table

	Country	ASCII code (hexadecimal number)											
		23	24	40	5B	5C	5D	5E	60	7B	7C	7D	7E
0	U.S.A.	#	\$	@	[\]	^	'	{		}	~
1	France	#	\$	à	°	ç	§	^	'	é	ù	è	¨
2	Germany	#	\$	§	Ä	Ö	Ü	^	'	ä	ö	ü	β
3	U.K.	£	\$	@	[\]	^	'	{		}	~
4	Denmark I	#	\$	@	Æ	Ø	Å	^	'	æ	ø	å	~
5	Sweden	#	¤	É	Ä	Ö	Å	Ü	é	ä	ö	å	ü
6	Italy	#	\$	@	°	\	é	^	ù	à	ò	è	ì
7	Spain	Pt	\$	@	ı	Ñ	ı	^	'	¨	ñ	}	~
8	Japan	#	\$	@	[¥]	^	'	{		}	~
9	Norway	#	¤	É	Æ	Ø	Å	Ü	é	æ	ø	å	ü
10	Denmark II	#	\$	É	Æ	Ø	Å	Ü	é	æ	ø	å	ü